

# GRAYCO

## MOULDING CATALOG

VERSION 2023



[WWW.GRAYCOINC.COM](http://WWW.GRAYCOINC.COM)

BLUFFTON  
345 BUCK ISLAND RD, BLUFFTON SC 29910  
(843) 815-5788 FAX 815-5799

LADY'S ISLAND  
20 SAMS POINT WAY, BEAUFORT SC 29907  
(843) 522-9994 FAX 522-9972

# PROFILE INDEX

| PROFILE  | PAGE | TYPE  | T        | W        |
|----------|------|-------|----------|----------|
| GCM1212  | 1    | CROWN | 1-1/2"   | 5-3/4"   |
| GCM1509  | 1    | CROWN | 1-3/4"   | 9"       |
| GCM3.5   | 1    | CROWN | 3/4"     | 3-1/2"   |
| GCM795   | 1    | CROWN | 1-1/4"   | 4-1/4"   |
| GCM1076  | 2    | CROWN | 1-3/4"   | 7-3/16"  |
| GCM30    | 2    | CROWN | 13/16"   | 3"       |
| GCM575   | 2    | CROWN | 1-1/16"  | 4-1/4"   |
| GCM610   | 2    | CROWN | 1-1/16"  | 3-1/4"   |
| GCM81    | 2    | CROWN | 5/8"     | 2"       |
| GCM84    | 2    | CROWN | 9/16"    | 2-1/4"   |
| GCM85    | 2    | CROWN | 9/16"    | 1-3/4"   |
| GCM86    | 2    | CROWN | 5/8"     | 1-1/2"   |
| GCM 609  | 3    | CROWN | 1-1/4"   | 4-9/16"  |
| GCM1213  | 3    | CROWN | 1-3/4"   | 6"       |
| GCM1266  | 3    | CROWN | 13/16"   | 4-1/2"   |
| GCM40358 | 3    | CROWN | 3/4"     | 3-5/8"   |
| GCMJ     | 3    | CROWN | 13/16"   | 4-3/16"  |
| GCMK     | 3    | CROWN | 1-1/8"   | 5-9/16"  |
| GCM1570  | 4    | CROWN | 1-11/16" | 8"       |
| GCM1674  | 4    | CROWN | 1-1/2"   | 4-1/2"   |
| GCM509   | 4    | CROWN | 3/4"     | 3-1/4"   |
| GCM533   | 4    | CROWN | 1-3/4"   | 8-1/2"   |
| GCM598   | 4    | CROWN | 1"       | 5-13/16" |
| GCM1210  | 5    | CROWN | 1-1/4"   | 5-5/8"   |
| GCM1718  | 5    | CROWN | 5/8"     | 2-1/8"   |
| GCM3661  | 5    | CROWN | 1"       | 7"       |
| GCM517   | 5    | CROWN | 1-3/16"  | 5-3/8"   |
| GCM611   | 5    | CROWN | 1-1/4"   | 5-13/16" |
| GCM1106  | 6    | CROWN | 1-3/4"   | 7-3/16"  |
| GCM619   | 6    | CROWN | 1-1/4"   | 5-9/16"  |
| GCM621   | 6    | CROWN | 7/8"     | 3-1/2"   |
| GCM674   | 6    | CROWN | 2-1/4"   | 8-13/16" |
| GCM1173  | 7    | CROWN | 1-1/16"  | 5-3/4"   |
| GCM623   | 7    | CROWN | 1"       | 5-5/8"   |
| GCM626   | 7    | CROWN | 3/4"     | 4-1/2"   |
| GCM632   | 7    | CROWN | 13/16"   | 2-1/2"   |
| GCM334   | 9    | CROWN | 11/16"   | 4-1/4"   |
| GCM335   | 9    | CROWN | 13/16"   | 6-1/4"   |
| GCM41245 | 9    | CROWN | 3/4"     | 5-1/2"   |
| GCM566   | 9    | CROWN | 1-1/4"   | 9-1/4"   |
| GCM605   | 9    | CROWN | 3/4"     | 4-7/16"  |
| GCM41    | 10   | CROWN | 3/4"     | 5-1/4"   |
| GCM534   | 10   | CROWN | 1-1/8"   | 5-1/2"   |
| GCM541   | 10   | CROWN | 1-3/4"   | 9-11/16" |
| GCM592   | 10   | CROWN | 1"       | 3-7/8"   |

# PROFILE INDEX

|          |    |       |          |          |
|----------|----|-------|----------|----------|
| GCM1325  | 11 | CROWN | 13/16"   | 3-1/2"   |
| GCM523   | 11 | CROWN | 13/16"   | 5-1/4"   |
| GCM68    | 11 | CROWN | 3/4"     | 3-5/16"  |
| GCM72    | 11 | CROWN | 9/16"    | 2-1/4"   |
| GCM726   | 11 | CROWN | 13/16"   | 2-1/2"   |
| GCM928   | 11 | CROWN | 1-1/16"  | 5-1/2"   |
| GCM939   | 11 | CROWN | 13/16"   | 4-5/8"   |
| GCM502   | 12 | CROWN | 7/8"     | 4"       |
| GCM506   | 12 | CROWN | 3/4"     | 3-1/2"   |
| GCM536   | 12 | CROWN | 7/8"     | 4-1/4"   |
| GCM538   | 12 | CROWN | 1"       | 3-3/8"   |
| GCM593   | 12 | CROWN | 3/4"     | 3-15/16" |
| GCM74    | 12 | CROWN | 9/16"    | 1-3/4"   |
| GCM45    | 13 | CROWN | 3/4"     | 5-1/4"   |
| GCM47    | 13 | CROWN | 3/4"     | 4-5/8"   |
| GCM49    | 13 | CROWN | 3/4"     | 3-5/8"   |
| GCM595   | 13 | CROWN | 11/16"   | 5-1/4"   |
| GCM712   | 13 | CROWN | 1-1/16"  | 5-1/2"   |
| GCM1011  | 14 | CROWN | 1-5/16"  | 9-1/8"   |
| GCM52    | 14 | CROWN | 9/16"    | 2-3/4"   |
| GCM53    | 14 | CROWN | 1/2"     | 2-3/16"  |
| GCM550   | 14 | CROWN | 5/8"     | 1-3/4"   |
| GCM589   | 14 | CROWN | 13/16"   | 6-1/4"   |
| GCM606   | 14 | CROWN | 13/16"   | 5-1/4"   |
| GCM1106  | 15 | CROWN | 1-3/4"   | 7-3/16"  |
| GCM1249  | 15 | CROWN | 1-1/4"   | 7"       |
| GCM1415  | 15 | CROWN | 5/8"     | 2-1/8"   |
| GCM46    | 15 | CROWN | 5/8"     | 5-1/4"   |
| GCM69    | 15 | CROWN | 5/8"     | 3-5/8"   |
| GCM40625 | 16 | CROWN | 7/8"     | 6-1/8"   |
| GCM44275 | 16 | CROWN | 13/16"   | 2-3/4"   |
| GCM542   | 16 | CROWN | 3/4"     | 4-1/8"   |
| GCM608   | 16 | CROWN | 1        | 7-1/4"   |
| GCM646   | 16 | CROWN | 1"       | 7-1/2"   |
| GCM1045  | 17 | CROWN | 3/4"     | 2-5/8"   |
| GCM5312  | 17 | CROWN | 3/4"     | 5-5/16"  |
| GCM56625 | 17 | CROWN | 1-1/8"   | 6-3/4"   |
| GCM590   | 17 | CROWN | 13/16"   | 4-11/16" |
| GCM599   | 17 | CROWN | 1"       | 6"       |
| GCM1056  | 18 | CROWN | 1-13/16" | 4-1/4"   |
| GCM1158  | 18 | CROWN | 1-1/4"   | 5-1/8"   |
| GCM503   | 18 | CROWN | 1-1/4"   | 2-3/4"   |
| GCM545   | 18 | CROWN | 1-3/8"   | 4-1/8"   |
| GCM561   | 18 | CROWN | 1-3/8"   | 3"       |
| GCM594   | 18 | CROWN | 1-1/16"  | 2-5/8"   |
| GCM13    | 19 | CROWN | 13/16"   | 5-9/16"  |
| GCM546   | 19 | CROWN | 3/4"     | 3-9/16"  |

# PROFILE INDEX

|          |    |       |         |          |
|----------|----|-------|---------|----------|
| GCM56    | 19 | CROWN | 13/16"  | 6-5/16"  |
| GCM601   | 19 | CROWN | 3/4"    | 7"       |
| GCM40107 | 20 | CROWN | 3/4"    | 4-1/2"   |
| GCM514   | 20 | CROWN | 3/4"    | 5-1/4"   |
| GCM596   | 20 | CROWN | 3/4"    | 2-1/4"   |
| GCM60    | 20 | CROWN | 13/16"  | 4-5/8"   |
| GCM655   | 20 | CROWN | 3/4"    | 5-1/4"   |
| GCM4055  | 21 | CROWN | 1"      | 5"       |
| GCM41235 | 21 | CROWN | 3/4"    | 5-1/2"   |
| GCM64456 | 21 | CROWN | 1-1/4"  | 4-5/8"   |
| GCM9875  | 21 | CROWN | 1-1/4"  | 5-1/2"   |
| GCM1131  | 22 | CROWN | 13/16"  | 4-1/2"   |
| GCM337   | 22 | CROWN | 3/4"    | 5-1/4"   |
| GCM531   | 22 | CROWN | 3/4"    | 3-1/2"   |
| GCM64111 | 22 | CROWN | 1-1/4"  | 4-1/4"   |
| GCM32    | 24 | CROWN | 1-1/8"  | 7-1/4"   |
| GCM44550 | 24 | CROWN | 13/16"  | 5-1/2"   |
| GCM57    | 24 | CROWN | 5/8"    | 3-1/4"   |
| GCM616   | 24 | CROWN | 13/16"  | 4"       |
| GCM24    | 25 | CROWN | 1-1/2"  | 7-3/4"   |
| GCM544   | 25 | CROWN | 3/4"    | 4-11/16" |
| GCM565   | 25 | CROWN | 7/8"    | 4-1/8"   |
| GCM622   | 25 | CROWN | 1-1/4"  | 7-7/8"   |
| GCM1010  | 26 | CROWN | 1-1/8"  | 5-15/16" |
| GCM1143  | 26 | CROWN | 1-1/4"  | 9"       |
| GCM44681 | 26 | CROWN | 13/16"  | 6-7/8"   |
| GCM529   | 26 | CROWN | 3/4"    | 2-5/16"  |
| GCM1112  | 28 | CROWN | 1/2"    | 1-11/16" |
| GCM500   | 28 | CROWN | 1-9/16" | 3-9/16"  |
| GCM501   | 28 | CROWN | 1-1/4"  | 6-1/2"   |
| GCM537   | 28 | CROWN | 3/4"    | 2"       |
| GCM967   | 28 | CROWN | 13/16"  | 2-1/2"   |
| GCM504   | 29 | CROWN | 1-1/8"  | 8-7/16"  |
| GCM505   | 29 | CROWN | 3/4"    | 4-1/4"   |
| GCM507   | 29 | CROWN | 1-1/16" | 6-9/16"  |
| GCM508   | 29 | CROWN | 5/8"    | 3-1/2"   |
| GCM1149  | 30 | CROWN | 1"      | 6-11/16" |
| GCM562   | 30 | CROWN | 1-3/16" | 7-5/16"  |
| GCM6     | 30 | CROWN | 1"      | 6-3/4"   |
| GCM1     | 31 | CROWN | 1-1/16" | 6-1/2"   |
| GCM33    | 31 | CROWN | 1-5/16" | 6-1/4"   |
| GCM515   | 31 | CROWN | 1-3/4"  | 8-5/16"  |
| GCM524   | 31 | CROWN | 3/4"    | 4"       |
| GCM35    | 32 | CROWN | 1-1/2"  | 6-5/8"   |
| GCM516   | 32 | CROWN | 1-3/8"  | 5-13/16" |
| GCM520   | 32 | CROWN | 1"      | 7-3/16"  |
| GCM519   | 33 | CROWN | 13/16"  | 4-9/16"  |



# PROFILE INDEX

|          |    |       |         |          |
|----------|----|-------|---------|----------|
| GCM522   | 33 | CROWN | 3/4"    | 7-1/4"   |
| GCM554   | 33 | CROWN | 13/16"  | 3-7/8"   |
| GCM615   | 33 | CROWN | 3/4"    | 5-1/2"   |
| GCM1637  | 34 | CROWN | 1-3/8"  | 5-1/8"   |
| GCM528   | 34 | CROWN | 1-3/8"  | 4-3/4"   |
| GCM555   | 34 | CROWN | 3/4"    | 3-1/2"   |
| GCM968   | 34 | CROWN | 1-7/16" | 5-1/2"   |
| GCM521   | 35 | CROWN | 1-1/2"  | 4-1/2"   |
| GCM526   | 35 | CROWN | 1"      | 4"       |
| GCM530   | 35 | CROWN | 1-5/8"  | 5-5/8"   |
| GCM624A  | 35 | CROWN | 1-3/4"  | 4-5/8"   |
| GCM1095  | 36 | CROWN | 3/4"    | 5"       |
| GCM535   | 36 | CROWN | 1-1/2"  | 6-11/16" |
| GCM584   | 36 | CROWN | 1-3/4"  | 5-7/8"   |
| GCM551   | 37 | CROWN | 1-1/4"  | 7-5/16"  |
| GCM553   | 37 | CROWN | 3/4"    | 5-1/4"   |
| GCM835   | 37 | CROWN | 1-3/8"  | 3-7/8"   |
| GCM5055  | 38 | CROWN | 1-1/16" | 5-5/8"   |
| GCM556   | 38 | CROWN | 3/4"    | 5"       |
| GCM567   | 38 | CROWN | 1-3/4"  | 9-1/4"   |
| GCM600   | 38 | CROWN | 1"      | 6"       |
| GCM1348  | 39 | CROWN | 13/16"  | 3-1/2"   |
| GCM50135 | 39 | CROWN | 1/2"    | 2-3/16"  |
| GCM558   | 39 | CROWN | 1-1/16" | 5-9/16"  |
| GCM560   | 39 | CROWN | 1-1/4"  | 7-7/8"   |
| GCM40349 | 40 | CROWN | 13/16"  | 6-1/16"  |
| GCM80012 | 40 | CROWN | 13/16"  | 5-1/2"   |
| GCM80019 | 40 | CROWN | 1-1/2"  | 5-5/8"   |
| GCM55    | 41 | CROWN | 1"      | 7-1/4"   |
| GCM563   | 41 | CROWN | 1-1/4"  | 5-1/2"   |
| GCM568   | 41 | CROWN | 15/16"  | 3-3/4"   |
| GCM603   | 41 | CROWN | 1-1/4"  | 5-1/2"   |
| GCM564   | 42 | CROWN | 1-3/8"  | 7-3/8"   |
| GCM569   | 42 | CROWN | 1"      | 5-11/16" |
| GCM576   | 42 | CROWN | 3/4"    | 5-3/16"  |
| GCM571   | 43 | CROWN | 1"      | 5-3/8"   |
| GCM572   | 43 | CROWN | 1-1/2"  | 6-5/16"  |
| GCM970   | 43 | CROWN | 1-1/4"  | 5-3/8"   |
| GCM577   | 44 | CROWN | 1"      | 5-5/8"   |
| GCM579   | 44 | CROWN | 1"      | 4-5/8"   |
| GCM582   | 44 | CROWN | 1-3/4"  | 5-11/16" |
| GCM671   | 44 | CROWN | 15/16"  | 4-5/8"   |
| GCM1108B | 45 | CROWN | 1-3/4"  | 11-1/4"  |
| GCM412   | 45 | CROWN | 3/4"    | 7"       |
| GCM580   | 45 | CROWN | CUSTOM  | CUSTOM   |
| GCM1246  | 46 | CROWN | 1-3/4"  | 4-3/8"   |
| GCM581   | 46 | CROWN | CUSTOM  | CUSTOM   |

# PROFILE INDEX

|                |    |        |         |           |
|----------------|----|--------|---------|-----------|
| GCM587         | 46 | CROWN  | 1-1/4"  | 4-5/16"   |
| GCM633         | 47 | CROWN  | 1-1/16" | 5-13/16"  |
| GCM634         | 47 | CROWN  | 3/4"    | 7"        |
| GCM1027        | 48 | CASING | 3/4"    | 3-1/2"    |
| GCM1152        | 48 | CASING | 7/8"    | 2-1/8"    |
| GCM1290        | 48 | CASING | 1"      | 4-1/2"    |
| GCM3.5 CROWN A | 48 | CASING | 13/16"  | 3-1/2"    |
| GCM361         | 48 | CASING | 11/16"  | 2-1/2"    |
| GCM452         | 48 | CASING | 3/4"    | 2-1/4"    |
| GCM60967       | 48 | CASING | 1-1/8"  | 4"        |
| GCM1003        | 49 | CASING | 1-1/16" | 3-1/2"    |
| GCM1017        | 49 | CASING | 1-1/16" | 3-1/2"    |
| GCM3           | 49 | CASING | 1-1/16" | 3-1/2"    |
| GCM40545       | 49 | CASING | 13/16"  | 3-9/16"   |
| GCM475         | 49 | CASING | 1"      | 4-1/4"    |
| GCM1017B       | 50 | CASING | 1-1/16" | 4-7/16"   |
| GCM1023        | 50 | CASING | 1-1/16" | 5"        |
| GCM1912        | 50 | CASING | 1-1/4"  | 3-1/2"    |
| GCM1913        | 50 | CASING | 1-1/4"  | 5"        |
| GCM414M        | 50 | CASING | 1-1/16" | 3-9/16"   |
| GCM40530       | 51 | CASING | 13/16"  | 4-1/4"    |
| GCM44145       | 51 | CASING | 11/16"  | 3-1/2"    |
| GCM460         | 51 | CASING | 1-1/16" | 3-11/16"  |
| GCM466         | 51 | CASING | 1-1/16" | 4-5/8"    |
| GCM826         | 51 | CASING | 1"      | 4-1/4"    |
| GCM1160        | 53 | CASING | 1-1/16" | 4-3/4"    |
| GCM1194        | 53 | CASING | 13/16"  | 4-1/2"    |
| GCM444         | 53 | CASING | 11/16"  | 3-1/2"    |
| GCM60425       | 53 | CASING | 1-1/4"  | 4-13/16"  |
| GCM60468       | 53 | CASING | 1-1/4"  | 4-1/8"    |
| GCM1155        | 54 | CASING | 1"      | 4-1/4"    |
| GCM1156        | 54 | CASING | 3/4"    | 3-1/2"    |
| GCM218         | 54 | CASING | 3/4"    | 3-1/2"    |
| GCM4006        | 54 | CASING | 3/4"    | 3-1/2"    |
| GCM4007        | 54 | CASING | 3/4"    | 3-1/2"    |
| GCM585         | 54 | CASING | 3/4"    | 3-1/2"    |
| GCM1154        | 54 | PLINTH | 1-1/8"  | 4-1/2"    |
| GCM40350       | 55 | CASING | 3/4"    | 3-1/2"    |
| GCM422         | 55 | CASING | 7/8"    | 4"        |
| GCM5406        | 55 | CASING | 1"      | 4-1/16"   |
| GCM787M        | 55 | CASING | 1-1/4"  | 4-1/2"    |
| GCM64466       | 55 | CASING | 1-1/4"  | 4-5/8"    |
| GCM1360        | 56 | CASING | 3/4"    | 4-3/8"    |
| GCM4257        | 56 | CASING | 3/4"    | 4-1/4"    |
| GCM44305       | 56 | CASING | 3/4"    | TO 5-1/2" |
| GCM4552        | 56 | CASING | 1"      | 3-1/4"    |
| GCM6441        | 56 | CASING | 1-1/8"  | 4-3/16"   |

# PROFILE INDEX

|          |    |        |          |          |
|----------|----|--------|----------|----------|
| GCM7007  | 56 | CASING | 13/16"   | 2-1/16"  |
| GCM1004  | 57 | CASING | 3/4"     | 3-1/2"   |
| GCM1008  | 57 | CASING | 3/4"     | 2-5/8"   |
| GCM1009  | 57 | CASING | 13/16"   | 3-1/2"   |
| GCM470   | 57 | CASING | 1-1/16"  | 3-11/16" |
| GCM769   | 57 | CASING | 13/16"   | 4"       |
| GCM1005  | 58 | CASING | 3/4"     | 4-1/2"   |
| GCM1013  | 58 | CASING | 3/4"     | 3-9/16"  |
| GCM1015  | 58 | CASING | 3/4"     | 3-1/2"   |
| GCM445   | 58 | CASING | 11/16"   | 3-1/4"   |
| GCM597B  | 58 | CASING | 7/8"     | 3-1/4"   |
| GCM1002  | 59 | CASING | 1-3/4"   | 3-1/2"   |
| GCM1006  | 59 | CASING | 1"       | 4-1/2"   |
| GCM1012  | 59 | CASING | 1"       | 5"       |
| GCM1032  | 59 | CASING | 1"       | 4-1/4"   |
| GCM1033  | 59 | CASING | 1-3/16"  | 4-1/4"   |
| GCM793   | 59 | CASING | 3/4"     | VARIES   |
| GCM1019  | 60 | CASING | 3/4"     | 3-1/2"   |
| GCM1020  | 60 | CASING | 13/16"   | 2-5/8"   |
| GCM1026  | 60 | CASING | 1"       | 3-9/16"  |
| GCM1037  | 60 | CASING | 3/4"     | 3-1/2"   |
| GCM117   | 60 | CASING | 3/4"     | 2-3/4"   |
| GCM1177  | 61 | CASING | 1/2"     | 2-7/8"   |
| GCM1179  | 61 | CASING | 1-1/8"   | 3-1/2"   |
| GCM455   | 61 | CASING | 3/4"     | 3"       |
| GCM8846  | 61 | CASING | 11/16"   | 4-1/2"   |
| GCM1018  | 62 | CASING | 1-3/16"  | 3"       |
| GCM1161  | 62 | CASING | 1"       | 4-1/2"   |
| GCM1170  | 62 | CASING | 1"       | 3-3/4"   |
| GCM1171  | 62 | CASING | 13/16"   | 3-3/4"   |
| GCM1024  | 63 | CASING | 11/16"   | 2-3/4"   |
| GCM1025  | 63 | CASING | 1-1/32"  | 3-15/16" |
| GCM1759  | 63 | CASING | 3/4"     | VARIES   |
| GCM226   | 63 | CASING | 3/4"     | VARIES   |
| GCM9025  | 63 | CASING | 7/8"     | 3"       |
| GCM10455 | 63 | PLINTH | 2-1/2"   | 5-1/2"   |
| GCM6002  | 63 | PLINTH | 2-1/4"   | 7"       |
| GCM6007  | 63 | PLINTH | 1-7/16"  | 4-1/2"   |
| GCM1038  | 64 | CASING | 1-1/32"  | 5"       |
| GCM1043  | 64 | CASING | 3/4"     | 2-1/2"   |
| GCM1529  | 64 | CASING | 11/16"   | 2-1/4"   |
| GCM209   | 64 | CASING | 1-1/16"  | 3-3/8"   |
| GCM2804  | 64 | PLINTH | 1-13/16" | 5"       |
| GCM6001  | 64 | PLINTH | 2-1/4"   | 5"       |
| GCM60967 | 64 | PLINTH | 1-5/16"  | 4-1/4"   |
| GCM1007  | 65 | CASING | 3/4"     | 5-1/2"   |
| GCM1159  | 65 | CASING | 17/32"   | 3-7/16"  |

# PROFILE INDEX

|             |    |         |          |         |
|-------------|----|---------|----------|---------|
| GCM1178     | 65 | CASING  | 3/4"     | 4"      |
| GCM1430     | 65 | CASING  | 3/4"     | 3-1/2"  |
| GCM3088     | 65 | CASING  | 3/4"     | 3-1/2"  |
| GCM1166     | 66 | CASING  | 13/16"   | 5-1/16" |
| GCM1172     | 66 | CASING  | 1-1/8"   | 4-1/4"  |
| GCM1174     | 66 | CASING  | 1-1/16"  | 3-1/2"  |
| GCM1175     | 66 | CASING  | 1-1/16"  | 4-3/8"  |
| GCM190      | 66 | CASING  | 1-1/4"   | 4-1/2"  |
| GCM1035     | 67 | CASING  | 5/8"     | 3-1/2"  |
| GCM180      | 67 | CASING  | 1-1/4"   | VARIES  |
| GCM1913 MOD | 67 | CASING  | 1-1/4"   | 7-1/4"  |
| GCM4501     | 67 | CASING  | 2"       | 2"      |
| GCM459      | 67 | CASING  | 3/4"     | 3-1/2"  |
| GCM1039     | 68 | CASING  | 3/4"     | 4-3/4"  |
| GCM1046     | 68 | CASING  | 7/8"     | 5-1/2"  |
| GCM1047     | 68 | CASING  | 7/8"     | 7"      |
| GCM1048     | 68 | CASING  | 11/16"   | 4-1/8"  |
| GCM1362     | 68 | CASING  | 3/4"     | 5-1/2"  |
| GCM427      | 69 | BACKBAN | VARIES   | 1-5/8"  |
| GCM946      | 69 | BACKBAN | 1-9/16"  | 1-3/4"  |
| GCM1229     | 69 | BASE    | 3/4      | VARIES  |
| GCM1506     | 69 | BASE    | 3/4"     | VARIES  |
| GCM1507     | 69 | BASE    | 3/4"     | VARIES  |
| GCM1546     | 69 | BASE    | 3/4"     | 7-1/4"  |
| GCM573      | 69 | BASE    | 1"       | VARIES  |
| GCM663      | 69 | BASE    | 3/4"     | VARIES  |
| GCM1175     | 69 | CASING  | 1-1/16"  | 4-3/8"  |
| GCM40530    | 69 | CASING  | 13/16"   | 4-1/4"  |
| GCM1151     | 69 | PLINTH  | 1-11/16" | 6-1/4"  |
| GCM4502     | 69 | PLINTH  | 15/16"   | 4-1/2"  |
| GCM8018     | 69 | PLINTH  | 2-3/16"  | 5-3/4"  |
| GCM518      | 70 | PLINTH  | 1-15/16" | 5-1/8"  |
| GCM6019     | 70 | PLINTH  | 1-5/8"   | 5-1/4"  |
| GCM6020     | 70 | PLINTH  | 1-3/4"   | 6-1/4'  |
| GCM104322   | 73 | CASING  | 2-5/32"  | 3-1/4"  |
| GCM1167     | 73 | CASING  | 2"       | 3-1/2"  |
| GCM1034     | 74 | BASE    | 3/4"     | VARIES  |
| GCM1514     | 74 | BASE    | 3/4"     | VARIES  |
| GCM1547     | 74 | BASE    | 3/4"     | VARIES  |
| GCM1759B    | 74 | BASE    | 3/4"     | VARIES  |
| GCM40925    | 74 | BASE    | 3/4"     | VARIES  |
| GCM650      | 74 | BASE    | 3/4"     | VARIES  |
| GCM1334     | 75 | BASE    | 3/4"     | VARIES  |
| GCM1515     | 75 | BASE    | 3/4"     | VARIES  |
| GCM1542     | 75 | BASE    | 11/16"   | VARIES  |
| GCM40125    | 75 | BASE    | 3/4"     | VARIES  |
| GCMSPEDBASE | 75 | BASE    | 3/4"     | VARIES  |



# PROFILE INDEX

|          |    |         |         |          |
|----------|----|---------|---------|----------|
| GCM1510  | 76 | BASE    | 1-1/8"  | VARIES   |
| GCM1512  | 76 | BASE    | 3/4"    | VARIES   |
| GCM4095  | 76 | BASE    | 3/4"    | VARIES   |
| GCM713   | 76 | BASE    | 13/16"  | VARIES   |
| GCM1538  | 76 | BASE    | 3/4"    | VARIES   |
| GCM1511  | 77 | BASE    | 3/4"    | 5-1/2"   |
| GCM1527  | 77 | BASE    | 3/4"    | 5-9/16"  |
| GCM1548  | 77 | BASE    | 9/16"   | 5-1/4"   |
| GCM44655 | 77 | BASE    | 11/16"  | VARIES   |
| GCM467   | 77 | BASE    | 11/16"  | 5-1/4"   |
| GCM695M2 | 77 | BASE    | 3/4"    | VARIES   |
| GCM1016  | 79 | BASE    | 1/2"    | VARIES   |
| GCM1513  | 79 | BASE    | 3/4"    | VARIES   |
| GCM1524  | 79 | BASE    | 3/4"    | VARIES   |
| GCM1807  | 79 | BASE    | 3/4"    | VARIES   |
| GCM620   | 79 | BASE    | 9/16"   | VARIES   |
| GCM1168  | 79 | BASECAP | 3/4"    | 1-3/16"  |
| GCM1534  | 79 | BASECAP | 3/4"    | 1"       |
| GCM1549  | 80 | BASE    | 3/4"    | VARIES   |
| GCM1550  | 80 | BASE    | 3/4"    | VARIES   |
| GCM665   | 80 | BASE    | 5/8"    | VARIES   |
| GCM1526  | 81 | BASE    | 5/8"    | 6"       |
| GCM44146 | 81 | BASE    | 3/4"    | VARIES   |
| GCM617   | 81 | BASE    | 1-1/16" | VARIES   |
| GCM66875 | 81 | BASE    | 11/16"  | VARIES   |
| GCM715   | 81 | BASE    | 3/4"    | VARIES   |
| GCM1505  | 82 | BASE    | 3/4"    | VARIES   |
| GCM1508  | 82 | BASE    | 11/16"  | 4-1/4"   |
| GCM40323 | 82 | BASE    | 5/8"    | 2-3/4"   |
| GCM664   | 82 | BASE    | 5/8"    | VARIES   |
| GCM1517  | 82 | BASE    | 3/4"    | 4-5/8"   |
| GCM1021  | 83 | BASE    | 3/4"    | 3-1/2"   |
| GCM115   | 83 | BASE    | 3/4"    | VARIES   |
| GCM1522  | 83 | BASE    | 3/4"    | 6"       |
| GCM1528  | 83 | BASE    | 3/4"    | VARIES   |
| GCM40105 | 83 | BASE    | 3/4"    | 3-15/16" |
| GCM1257  | 84 | BASE    | 13/16"  | VARIES   |
| GCM1501  | 84 | BASE    | 1"      | VARIES   |
| GCM1540  | 84 | BASE    | 3/4"    | VARIES   |
| GCM1701  | 84 | BASE    | 1"      | 7-1/4"   |
| GCM40876 | 84 | BASE    | 3/4"    | VARIES   |
| GCM1503  | 85 | BASE    | 1"      | VARIES   |
| GCM1518  | 85 | BASE    | 3/4"    | VARIES   |
| GCM40044 | 85 | BASE    | 7/8"    | 6-15/16" |
| GCM6021  | 85 | BASE    | 1-1/8"  | 7-1/2"   |
| GCM1535  | 86 | BASE    | 3/4"    | VARIES   |
| GCM1536  | 86 | BASE    | 3/4"    | VARIES   |

# PROFILE INDEX

|          |    |         |         |          |
|----------|----|---------|---------|----------|
| GCM1645  | 86 | BASE    | 1"      | VARIES   |
| GCM1530  | 86 | BASE    | 1-1/16" | 9-1/4"   |
| GCM1441  | 87 | BASE    | 1"      | 2-1/2"   |
| GCM1504  | 87 | BASE    | 5/8"    | 2-1/2"   |
| GCM1520  | 87 | BASE    | 9/16"   | 4-11/16" |
| GCM1525  | 87 | BASE    | 1/2"    | 5-1/4"   |
| GCM1543  | 87 | BASE    | 11/16"  | 5-1/8"   |
| GCM4005  | 87 | BASE    | 7/8"    | 4-1/4"   |
| GCM1502  | 88 | BASE    | 3/4"    | VARIES   |
| GCM1544  | 88 | BASE    | 1-3/16" | VARIES   |
| GCM1545  | 88 | BASE    | 3/4"    | VARIES   |
| GCM1335  | 89 | BASECAP | 5/8"    | 1-3/8"   |
| GCM163   | 89 | BASECAP | 11/16"  | 1-3/8"   |
| GCM189   | 89 | BASECAP | 7/8"    | 3"       |
| GCM2021  | 89 | BASECAP | 1"      | 1-1/2"   |
| GCM2023  | 89 | BASECAP | 1-3/16" | 1-9/16"  |
| GCM2024  | 89 | BASECAP | 1"      | 1-1/4"   |
| GCM2028  | 89 | BASECAP | 13/16"  | 1-1/4"   |
| GCM2033  | 89 | BASECAP | 13/16"  | 2-3/16"  |
| GCM268   | 89 | BASECAP | 11/16"  | 2-1/4"   |
| GCM42    | 89 | BASECAP | 1-1/16" | 1-9/16"  |
| GCM42R   | 89 | BASECAP | 1-1/16" | 1-9/16"  |
| GCM5514  | 89 | BASECAP | 7/16"   | 1-1/16"  |
| GCM5521  | 89 | BASECAP | 9/16"   | 1-3/8"   |
| GCM5523  | 89 | BASECAP | 7/16"   | 1-3/16"  |
| GCM6068  | 89 | BASECAP | 3/4"    | 1-1/4"   |
| GCM1720  | 90 | BASECAP | 1"      | 1-3/8"   |
| GCM1914  | 90 | BASECAP | 1"      | 2-3/8"   |
| GCM2019  | 90 | BASECAP | 5/8"    | 1-3/16"  |
| GCM2020  | 90 | BASECAP | 9/16"   | 1-1/2"   |
| GCM2025  | 90 | BASECAP | 3/4"    | 1-11/16" |
| GCM2029  | 90 | BASECAP | 11/16"  | 1-13/16" |
| GCM2030  | 90 | BASECAP | 3/4"    | 1-7/16"  |
| GCM214   | 90 | BASECAP | 1-1/16" | 1-1/2"   |
| GCM40103 | 90 | BASECAP | 3/4"    | 1-1/4"   |
| GCM40175 | 90 | BASECAP | 3/4"    | 1-3/4"   |
| GCM40375 | 90 | BASECAP | 3/4"    | 1-3/8"   |
| GCM5515  | 90 | BASECAP | 3/4"    | 1-1/16"  |
| GCM5518  | 90 | BASECAP | 1/2"    | 13/16"   |
| GCM5519  | 90 | BASECAP | 1/2"    | 1-1/16"  |
| GCM6060  | 90 | BASECAP | 3/4"    | 1-1/2"   |
| GCM641   | 90 | BASECAP | 3/4"    | 1-3/4"   |
| GCM739   | 90 | BASECAP | 1"      | 1-3/8"   |
| GCM133   | 91 | BASECAP | 13/16"  | 1-5/16"  |
| GCM14    | 91 | BASECAP | 1-1/8"  | 2-3/8"   |
| GCM1720M | 91 | BASECAP | 1"      | 2-3/8"   |
| GCM2034  | 91 | BASECAP | 7/8"    | 1-1/2"   |

# PROFILE INDEX

|          |    |         |         |          |
|----------|----|---------|---------|----------|
| GCM424   | 91 | BASECAP | 3/4"    | 1-1/4"   |
| GCM44175 | 91 | BASECAP | 13/16"  | 1-3/4"   |
| GCM4425  | 91 | BASECAP | 1-3/16" | 1-7/8"   |
| GCM574   | 91 | BASECAP | 3/4"    | 1-1/2"   |
| GCM64187 | 91 | BASECAP | 1-1/8"  | 1-7/8"   |
| GCM80    | 91 | BASECAP | 1"      | 1-3/8"   |
| GCM914   | 91 | BASECAP | 3/4"    | 1-1/8"   |
| GCM932   | 91 | BASECAP | 1-1/16" | 2-3/16"  |
| GCM94    | 91 | BASECAP | 1"      | 1-3/4"   |
| GCM198   | 92 | BASECAP | 1"      | 2"       |
| GCM2001  | 92 | BASECAP | 1-3/8"  | 2-5/16"  |
| GCM2002  | 92 | BASECAP | 3/4"    | 1-3/8"   |
| GCM2003  | 92 | BASECAP | 1-1/16" | 1-5/8"   |
| GCM2004  | 92 | BASECAP | 7/8"    | 1-15/16" |
| GCM3055  | 92 | BASECAP | 1-1/4"  | 2-5/16"  |
| GCM5520  | 92 | BASECAP | 1-1/16" | 1-7/8"   |
| GCM672   | 92 | BASECAP | 1-1/16" | 1-11/16" |
| GCM934   | 92 | BASECAP | 11/16"  | 1-7/8"   |
| GCM977   | 92 | BASECAP | 11/16"  | 1-9/16"  |
| GCM1085  | 93 | BASECAP | VARIES  | 1-5/32"  |
| GCM1111  | 93 | BASECAP | 7/8"    | 1-7/8"   |
| GCM1539  | 93 | BASECAP | 1-1/2"  | 1-1/4"   |
| GCM2006  | 93 | BASECAP | 3/4"    | 1-1/8"   |
| GCM2007  | 93 | BASECAP | 13/16"  | 15/16"   |
| GCM2008  | 93 | BASECAP | 7/8"    | 1-3/4"   |
| GCM2010  | 93 | BASECAP | 17/32"  | 1-1/16"  |
| GCM2012  | 93 | BASECAP | 3/4"    | 1-7/16"  |
| GCM2017  | 93 | BASECAP | 1"      | 2"       |
| GCM31    | 93 | BASECAP | 13/16"  | 1-3/16"  |
| GCM36    | 93 | BASECAP | 1-5/16" | 1-15/16" |
| GCM453   | 93 | BASECAP | 3/4"    | 1"       |
| GCM1533  | 94 | BASECAP | 3/4"    | 3-1/2"   |
| GCM1676  | 94 | BASECAP | 1-3/8"  | 2-1/8"   |
| GCM1808  | 94 | BASECAP | 9/16"   | 13/16"   |
| GCM431   | 94 | BASECAP | 3/4"    | 1-1/4"   |
| GCM573BC | 94 | BASECAP | 1-1/4"  | 2"       |
| GCM1489  | 95 | BACKBAN | VARIES  | 1-3/16"  |
| GCM17    | 95 | BACKBAN | VARIES  | 1-5/16"  |
| GCM284   | 95 | BACKBAN | VARIES  | 1-3/16"  |
| GCM313   | 95 | BACKBAN | VARIES  | 1-1/2"   |
| GCM427   | 95 | BACKBAN | VARIES  | 1-5/8"   |
| GCM434   | 95 | BACKBAN | VARIES  | 1-1/8"   |
| GCM50719 | 95 | BACKBAN | VARIES  | 1-1/16"  |
| GCM628   | 95 | BACKBAN | VARIES  | 2"       |
| GCM8809  | 95 | BACKBAN | VARIES  | 1-3/8"   |
| GCM158   | 96 | BACKBAN | VARIES  | 1-5/8"   |
| GCM1609  | 96 | BACKBAN | VARIES  | 1-3/4"   |

# PROFILE INDEX

|              |     |         |         |          |
|--------------|-----|---------|---------|----------|
| GCM280       | 96  | BACKBAN | VARIES  | 1-1/2"   |
| GCM510       | 96  | BACKBAN | VARIES  | 1-9/16"  |
| GCM511       | 96  | BACKBAN | VARIES  | 1-5/16"  |
| GCM64414     | 96  | BACKBAN | 1-1/4"  | 1-1/4"   |
| GCM730       | 96  | BACKBAN | VARIES  | 1-5/8"   |
| GCM84125     | 96  | BACKBAN | VARIES  | 1-1/2"   |
| GCM84875     | 96  | BACKBAN | VARIES  | 1-1/16"  |
| GCM1556      | 97  | BACKBAN | VARIES  | 1-1/8"   |
| GCM2501      | 97  | BACKBAN | VARIES  | 1-5/8"   |
| GCM2502      | 97  | BACKBAN | VARIES  | 1-1/4"   |
| GCM2503      | 97  | BACKBAN | VARIES  | 7/8"     |
| GCM2504      | 97  | BACKBAN | VARIES  | 1-1/2"   |
| GCM2507      | 97  | BACKBAN | VARIES  | 1-1/4"   |
| GCM289       | 97  | BACKBAN | VARIES  | 1-1/16"  |
| GCM513       | 97  | BACKBAN | VARIES  | 1-1/8"   |
| GCM64221     | 97  | BACKBAN | VARIES  | 1-1/4"   |
| GCM1044      | 98  | BACKBAN | VARIES  | 3-1/4"   |
| GCM15        | 98  | BACKBAN | VARIES  | 1-13/16" |
| GCM18        | 98  | BACKBAN | VARIES  | 1-9/16"  |
| GCM2510      | 98  | BACKBAN | VARIES  | 1-5/8"   |
| GCM2512      | 98  | BACKBAN | VARIES  | 1-5/8"   |
| GCM2513      | 98  | BACKBAN | VARIES  | 2-1/8"   |
| GCM946       | 98  | BACKBAN | 1-9/16" | 1-3/4"   |
| GCMDB-8 BB   | 98  | BACKBAN | VARIES  | 1-5/8"   |
| GCM1763      | 99  | BACKBAN | VARIES  | 2-1/8"   |
| GCM2514      | 99  | BACKBAN | VARIES  | 2-7/8"   |
| GCM2515      | 99  | BACKBAN | 1-3/16" | 1"       |
| GCM2516      | 99  | BACKBAN | VARIES  | 1"       |
| GCM2517      | 99  | BACKBAN | VARIES  | 1-9/16"  |
| GCM2518      | 99  | BACKBAN | VARIES  | 1-5/8"   |
| GCM2519      | 99  | BACKBAN | VARIES  | 1-1/4"   |
| GCM281       | 99  | BACKBAN | VARIES  | 1-1/16"  |
| GCM6006      | 100 | MISC    | 1-3/4"  | 2-1/16"  |
| GCM6009      | 100 | MISC    | 1-1/8"  | 2"       |
| GCM6022      | 100 | MISC    | 3/4"    | 3-1/2"   |
| GCM6026      | 100 | MISC    | 1-3/4"  | 3-1/2"   |
| GCM759       | 100 | MISC    | 1"      | 1-1/2"   |
| GCM90LM      | 100 | MISC    | 3/4"    | VARIES   |
| GCM6013      | 101 | MISC    | 1"      | VARIES   |
| GCM9522      | 101 | MISC    | 1"      |          |
| GCMANDERSEN  | 101 | MISC    | 11/16"  | VARIES   |
| GCMCROWNTRUS | 101 | MISC    | SPECIAL |          |
| GCM3008      | 102 | MISC    | 2"      | 2"       |
| GCM6053      | 102 | MISC    | 3/4"    | 3/4"     |
| GCM8009      | 102 | MISC    | 3/8"    | 1-1/8"   |
| GCM105       | 102 | MISC    | 3/4"    | 3/4"     |
| GCM108       | 102 | MISC    | 1/2"    | 1/2"     |



# PROFILE INDEX

|               |     |      |        |         |
|---------------|-----|------|--------|---------|
| GCM129        | 102 | MISC | 1/2"   | 3/4"    |
| GCM3001       | 102 | MISC | 1-1/4" | 1-1/4"  |
| GCM3002       | 102 | MISC | 1"     | 1"      |
| GCM3003       | 102 | MISC | 3/8"   | 3/4"    |
| GCM3007       | 102 | MISC | 1-1/2" | 1-1/2"  |
| GCM807        | 102 | MISC | 3/4"   | 1-1/16" |
| GCM8501       | 102 | MISC | 1/2"   | 13/16"  |
| GCM8502       | 102 | MISC | 7/16"  | 1"      |
| GCM8503       | 102 | MISC | 1/2"   | 1"      |
| GCM985        | 102 | MISC | 3/8"   | 2"      |
| GCM988        | 102 | MISC | 3/8"   | 1-1/2"  |
| GCMPARTINGBEA | 102 | MISC | 3/8"   | 1-3/16" |
| GCM451        | 103 | MISC | 5/8"   | 1"      |
| GCM6033       | 103 | MISC | 1/2"   | 3/4"    |
| GCM6045       | 103 | MISC | 1-1/4" | 2"      |
| GCM6046       | 103 | MISC | 1/2"   | 1/2"    |
| GCM6047       | 103 | MISC | 3/4"   | 3/4"    |
| GCM6048       | 103 | MISC | 5/8"   | 5/8"    |
| GCM100        | 103 | MISC | 11/16" | 11/16"  |
| GCM101        | 103 | MISC | 1"     | 1"      |
| GCM3004       | 103 | MISC | 3/8"   | 3/8"    |
| GCM3006       | 103 | MISC | 3/4"   | 3/4"    |
| GCM5517       | 103 | MISC | 9/16"  | 9/16"   |
| GCM6005       | 103 | MISC | 2-1/2" | 2-1/2"  |
| GCM6011       | 103 | MISC | 7/16"  | 1/2"    |
| GCM6012       | 103 | MISC | 1/2"   | 1/2"    |
| GCM6015       | 103 | MISC | 5/8"   | 5/8"    |
| GCM6016       | 103 | MISC | 5/8"   | 5/8"    |
| GCM6017       | 103 | MISC | 1/2"   | 9/16"   |
| GCM6066       | 103 | MISC | 1/2"   | 1/2"    |
| GCM607        | 103 | MISC | 5/8"   | 5/8"    |
| GCM819        | 103 | MISC | 11/32" | 1/2"    |
| GCM97         | 103 | MISC | 5/8"   | 5/8"    |
| GCM99         | 103 | MISC | 1/2"   | 3/4"    |
| GCM1061       | 104 | MISC | 17/32" | 3/4"    |
| GCM1414       | 104 | MISC | 1"     | 2"      |
| GCM173        | 104 | MISC | 5/8"   | 3/4"    |
| GCM195        | 104 | MISC | 5/8"   | 7/8"    |
| GCM231        | 104 | MISC | 3/4"   | 3/4"    |
| GCM273        | 104 | MISC | 3/4"   | 1-5/8"  |
| GCM40068      | 104 | MISC | 7/16"  | 11/16"  |
| GCM4175       | 104 | MISC | 3/4"   | 1"      |
| GCM5510       | 104 | MISC | 1/2"   | 5/8"    |
| GCM604        | 104 | MISC | 3/8"   | 9/16"   |
| GCM6051       | 104 | MISC | 5/8"   | 3/4"    |
| GCM6057       | 104 | MISC | 3/4"   | 1"      |
| GCM6058       | 104 | MISC | 11/16" | 1-1/8"  |

# PROFILE INDEX

|                   |     |      |          |          |
|-------------------|-----|------|----------|----------|
| GCM6061           | 104 | MISC | 13/16"   | 1"       |
| GCM6065           | 104 | MISC | 11/16"   | 7/8"     |
| GCM8007           | 104 | MISC | 3/8"     | 1/2"     |
| GCM9026           | 104 | MISC | 11/16"   | 1-9/16"  |
| GCM9550           | 104 | MISC | 7/8"     | 7/8"     |
| GCM972            | 104 | MISC | 1-1/8"   | 1-1/8"   |
| GCM987            | 104 | MISC | 3/8"     | 1/2"     |
| GCM6027           | 104 | MISC | 3/4"     | 1-3/4"   |
| GCM6028           | 104 | MISC | 1"       | 1-1/4"   |
| GCM6029           | 104 | MISC | 3/8"     | 15/16"   |
| GCM6055           | 104 | MISC | 5/8"     | 7/8"     |
| 1-1/8 X 1-1/2 COR | 105 | MISC | 1-1/8"   | 1-1/2"   |
| 3/4X1 CORNER TR   | 105 | MISC | 3/4"     | 1"       |
| GCM1063           | 105 | MISC | 3/4"     | 1-3/4"   |
| GCM1064           | 105 | MISC | 5/8"     | 7/8"     |
| GCM1219           | 105 | MISC | 1-1/16"  | 1-5/8"   |
| GCM5506           | 105 | MISC | 1-1/4"   | 2-1/4"   |
| GCM6508           | 105 | MISC | 1        | 2-1/2"   |
| GCM7004           | 105 | MISC | 7/16"    | 3-5/16"  |
| GCM7011           | 105 | MISC | 9/16"    | 2-1/2"   |
| GCM8142           | 105 | MISC | 11/16"   | 1-1/4"   |
| GCM989            | 105 | MISC | 3/8"     | VARIES   |
| GCM955            | 105 | MISC | 3/8"     | VARIES   |
| GCM1721A          | 106 | MISC | 1-15/32" | 2-7/8"   |
| GCM1721B          | 106 | MISC | 1-1/32"  | 1-17/32" |
| GCM6008           | 106 | MISC | 1        | 3-1/2"   |
| GCM6036 DP        | 106 | MISC | 3/4"     | 1-1/4"   |
| GCM6059           | 106 | MISC | 1-5/8"   | 1"       |
| GCM8012           | 106 | MISC | 3-1/4"   | 3-1/4"   |
| GCM1029           | 106 | MISC | 1-3/8"   | 2-3/4"   |
| GCM1042           | 107 | MISC | 1-1/2"   | 2-1/4"   |
| GCM1438           | 107 | MISC | 1-1/2"   | 2"       |
| GCM2022           | 107 | MISC | 3/4"     | 1"       |
| GCM5507           | 107 | MISC | 13/16"   | 1-5/16"  |
| GCM5508           | 107 | MISC | 3/4"     | 1-1/16"  |
| GCM5509           | 107 | MISC | 3/4"     | 1-11/16" |
| GCM6052           | 107 | MISC | 1/2"     | 1"       |
| GCM675            | 107 | MISC | 15/16"   | 2-1/16"  |
| GCM6030           | 107 | MISC | 1-1/4"   | 2-1/4"   |
| GCM6031           | 107 | MISC | 1-3/8"   | 2-1/2"   |
| GCM6040           | 107 | MISC | 1-1/4"   | 3-1/2"   |
| GCM588            | 108 | MISC | 2-1/4"   | 2-3/4"   |
| GCM586            | 108 | MISC | 1-1/2"   | 2-3/8"   |
| GCM6049           | 108 | MISC | 2"       | 7-1/8"   |
| GCM8252           | 108 | MISC | 1-5/16"  | 2"       |
| GCM8250           | 108 | MISC | 1-3/8"   | 4-3/8"   |
| GCM1180           | 108 | TRIM | 1"       | 1-7/8"   |

# PROFILE INDEX

|              |     |          |         |         |
|--------------|-----|----------|---------|---------|
| GCM8251A     | 109 | MISC     | 1-7/8"  | 2-1/2"  |
| GCM8251B     | 109 | MISC     | 2-3/4"  | 3"      |
| GCM1014      | 109 | MISC     | 2-1/2"  | 5"      |
| GCM8016      | 110 | MISC     | 2"      | 3-1/4"  |
| GCM8014B     | 110 | MISC     | 1-7/16" | 4-1/16" |
| GCM8014A     | 110 | MISC     | 13/16"  | 2-1/4"  |
| GCM8013      | 110 | MISC     | 3/4"    | 6-1/16" |
| GCM8017      | 111 | MISC     | 1-1/4"  | 5-1/2"  |
| GCM6501      | 112 | STOOL    | 1-1/16" | VARIES  |
| GCM6502      | 112 | STOOL    | 1/2"    | VARIES  |
| GCM6503      | 112 | STOOL    | 3/8"    | VARIES  |
| GCM6504      | 112 | STOOL    | 3/4"    | VARIES  |
| GCM6509      | 112 | STOOL    | 1-1/4"  | VARIES  |
| GCM6505      | 112 | STOOL    | 1"      | VARIES  |
| GCM6506      | 112 | STOOL    | 5/8"    | VARIES  |
| GCM6510      | 112 | STOOL    | 1-1/2"  | VARIES  |
| GCM1185      | 112 | STOOL    | 1-1/8"  | VARIES  |
| GCM1102      | 113 | STOOL    | 1"      | VARIES  |
| GCM1176      | 113 | STOOL    | 1-1/4"  | VARIES  |
| GCM1195      | 113 | STOOL    | 13/16"  | 3"      |
| GCM2505      | 113 | STOOL    | 1"      | VAR.    |
| GCM2506      | 113 | STOOL    | 1-7/16" | VAR.    |
| GCM6507      | 113 | STOOL    | 1"      | 2-1/2"  |
| GCM673       | 113 | STOOL    | 1-1/4"  | VARIES  |
| GCM8006      | 113 | STOOL    | 1       | VARIES  |
| GCM6511      | 114 | STOOL    | 1-1/2"  | 3-1/4"  |
| GCM6514      | 114 | STOOL    | 2"      | VARIES  |
| GCM6513      | 114 | STOOL    | 3"      | 3"      |
| GCM6512      | 114 | STOOL    | 1-1/2"  | 3-1/4"  |
| GCM8020      | 115 | APPRON   | 11-16"  | 2-1/4"  |
| GCM6064      | 115 | APPRON   | 5/8"    | 1-7/8"  |
| GCM1150      | 115 | APPRON   | 13/16"  | 3-1/2"  |
| GCM2         | 115 | APPRON   | 3/4"    | VARIES  |
| GCM212       | 115 | APPRON   | 5/8"    | 2-1/2"  |
| GCM220       | 115 | APPRON   | 5/8"    | 1-3/4"  |
| GCM207       | 115 | APPRON   | 11/16"  | 2-1/2"  |
| GCM4001      | 115 | APPRON   | 3/4"    | 2-1/2"  |
| GCM4004      | 115 | APPRON   | 13/16"  | 2-9/16" |
| GCM5010      | 116 | HANDRAIL | 2-5/16" | 2-7/8"  |
| GCM5019      | 116 | HANDRAIL | 2-3/8"  | 2-1/4"  |
| GCM6010      | 116 | HANDRAIL | 2-1/4"  | 2-3/8"  |
| GCM6010 3.75 | 116 | HANDRAIL | 2-7/16" | 3-3/4"  |
| GCM6210      | 116 | HANDRAIL | 2-5/8"  | 2-3/8"  |
| GCM7000      | 116 | HANDRAIL | 2-1/4"  | 2-7/8"  |
| GCM5006      | 117 | HANDRAIL | 2-1/4"  | 2-3/4"  |
| GCM5012      | 117 | HANDRAIL | 2-1/8"  | 2-5/8"  |
| GCM5032      | 117 | HANDRAIL | 2-1/8"  |         |

# PROFILE INDEX

|           |     |          |          |          |
|-----------|-----|----------|----------|----------|
| GCM5034   | 117 | HANDRAIL | 2-5/16"  | 4-1/2"   |
| GCM5037   | 117 | HANDRAIL | 1-11/6"  | 2-5/8"   |
| GCM5007   | 117 | HANDRAIL | 2-1/4"   | 2-1/4"   |
| GCM5002   | 118 | HANDRAIL | 3"       | 6"       |
| GCM5053   | 118 | HANDRAIL | 2"       | 2-1/4"   |
| GCM5004   | 118 | HANDRAIL | 3-1/8"   | 3-1/2"   |
| GCM5021   | 118 | HANDRAIL | 1-9/16"  | 2-1/8"   |
| GCM5030   | 118 | HANDRAIL | 1-1/2"   | 4-1/2"   |
| GCM5013   | 119 | HANDRAIL | 1-7/16"  | 3-3/8"   |
| GCM5014   | 119 | HANDRAIL | 2"       | 3-1/2"   |
| GCM5024   | 119 | HANDRAIL | 1-1/2"   | 6-5/8"   |
| GCM5040   | 119 | HANDRAIL | 7/8"     | 2"       |
| GCM5405   | 119 | HANDRAIL | 1"       | 4-1/2"   |
| GCM84215  | 119 | HANDRAIL | 1-1/2"   | 2-13/16" |
| GCM5057   | 120 | HANDRAIL | 1-15/16" | 2-3/4"   |
| GCM5056   | 120 | HANDRAIL | 2-1/4"   | 3-5/16"  |
| GCM5005   | 120 | HANDRAIL | 3-1/4"   | 3-1/2"   |
| GCM1453   | 121 | HANDRAIL | 1-15/16" | 2-1/4"   |
| GCM5009   | 121 | HANDRAIL | 7/8"     | 3-1/2"   |
| GCM5011   | 121 | HANDRAIL | 1-1/2"   |          |
| GCM5018   | 121 | HANDRAIL | 2"       |          |
| GCM5049   | 121 | HANDRAIL | 2-1/4"   | 2-1/4"   |
| GCM6069   | 121 | HANDRAIL | 3/4"     | 3/4"     |
| GCM5026   | 121 | HANDRAIL | 3"       |          |
| GCM5043   | 121 | HANDRAIL | 2-3/4"   | DIA      |
| GCM5050   | 121 | HANDRAIL | 1-1/4"   | 2-1/4"   |
| GCM5047   | 122 | HANDRAIL | 1-7/16"  | 5-1/8"   |
| GCM5027   | 122 | HANDRAIL | 3"       | 5-1/2"   |
| GCM5048   | 122 | HANDRAIL | 3-1/4"   | 3"       |
| GCM5007   | 122 | HANDRAIL | 2-1/4"   | 2"       |
| GCM5008   | 123 | HANDRAIL | 1-1/2"   | 3-1/2"   |
| GCM5015   | 123 | HANDRAIL | 1-1/2"   | 3-1/2"   |
| GCM84325  | 123 | HANDRAIL | 1-1/2"   | 3-1/4"   |
| GCM84325C | 123 | HANDRAIL | 1-1/2"   | 3-1/4"   |
| GCM5031   | 124 | HANDRAIL | 1-1/2"   | 4-1/2"   |
| GCM5033   | 124 | HANDRAIL | 1-1/2"   | 3-1/2"   |
| GCM5039   | 124 | HANDRAIL | 7/8"     | 2-1/2"   |
| GCM5045   | 124 | HANDRAIL | 2-1/4"   | 3-3/4"   |
| GCM5028   | 125 | HANDRAIL | 2-3/4"   | 5-1/2"   |
| GCM5029   | 125 | HANDRAIL | 2"       | 7"       |
| GCM5023   | 126 | HANDRAIL | 3-1/4"   | 5-1/4"   |
| GCM5025   | 126 | HANDRAIL | 3"       | 5"       |
| GCM5035   | 127 | HANDRAIL | 3-1/4"   | 3-1/8"   |
| GCM5038   | 127 | HANDRAIL | 2"       | 2-5/8"   |
| GCM5044   | 127 | HANDRAIL | 2-11/16" | 5-3/16"  |
| GCM84305  | 127 | HANDRAIL | 1-1/2"   | 3-1/2"   |
| GCM5042   | 128 | HANDRAIL | 1-1/4"   | 5"       |



# PROFILE INDEX

|          |     |            |         |          |
|----------|-----|------------|---------|----------|
| GCM5054  | 128 | HANDRAIL   | 2-1/2"  | 2"       |
| GCM5051  | 128 | HANDRAIL   | 2-1/4"  | 5"       |
| GCM5046  | 129 | HANDRAIL   | 3-1/4"  | 4-3/16"  |
| GCM5041  | 129 | HANDRAIL   | 3-1/16" | 6-3/4"   |
| GCM5046  | 129 | HANDRAIL   | 3-1/4"  | 4-3/16"  |
| GCM5016  | 130 | HANDRAIL   | 2-1/2"  | 5-1/2"   |
| GCM5017  | 130 | HANDRAIL   | 2-1/2"  | 3-1/2"   |
| GCM5022  | 130 | HANDRAIL   | 2-1/4"  | 5-1/4"   |
| GCM1218  | 131 | PANEL MLDG | 7/16"   | 1-9/16"  |
| GCM1260  | 131 | PANEL MLDG | 1-1/8"  | 2"       |
| GCM1471  | 131 | PANEL MLDG | 1-1/16" | 2-1/4"   |
| GCM1483  | 131 | PANEL MLDG | 1"      | 3-1/2"   |
| GCM5503  | 131 | PANEL MLDG | 21/32"  | 1-1/2"   |
| GCM5505  | 131 | PANEL MLDG | 1"      | 2-7/8"   |
| GCM5513  | 131 | PANEL MLDG | 15/16"  | 2-13/16" |
| GCM80817 | 131 | PANEL MLDG | 1-1/2"  | 2-1/4"   |
| GCM9809  | 131 | PANEL MLDG | 1-1/16" | 2-1/8"   |
| GCM9855  | 131 | PANEL MLDG | 1-1/4"  | 2-7/8"   |
| GCM1040  | 132 | PANEL MLDG | 9/16"   | 1/2"     |
| GCM1105  | 132 | PANEL MLDG | 1-3/4"  | 2-1/4"   |
| GCM135   | 132 | PANEL MLDG | 1-1/8"  | 5/8"     |
| GCM2015  | 132 | PANEL MLDG | 7/8"    | 1-1/2"   |
| GCM2016  | 132 | PANEL MLDG | 15/16"  | 1-3/32"  |
| GCM5516  | 132 | PANEL MLDG | 1-1/2"  | 2-1/4"   |
| GCM3041  | 132 | PANEL MLDG | 1-1/16" | 1-3/4"   |
| GCM3513  | 132 | PANEL MLDG | 1-1/8"  | 2"       |
| GCM50041 | 132 | PANEL MLDG | 1-1/16" | 2-1/16"  |
| GCM5504  | 132 | PANEL MLDG | 7/8"    | 1"       |
| GCM6024  | 132 | PANEL MLDG | 5/8"    | 3/4"     |
| GCM6063  | 132 | PANEL MLDG | 1/2"    | 1-3/8"   |
| GCM6025  | 132 | PANEL MLDG | 1/2"    | 11/16"   |
| GCM649   | 132 | PANEL MLDG | 1/2"    | 3/4"     |
| GCM5052  | 132 | PANEL MLDG | 1"      | 1-3/8"   |
| GCM898   | 132 | PANEL MLDG | 3/8"    | 1-1/4"   |
| GCM1259  | 133 | PANEL MLDG | 3/4"    | 1-1/4"   |
| GCM16    | 133 | PANEL MLDG | 1-1/8"  | 1-7/8"   |
| GCM1788  | 133 | PANEL MLDG | 1-3/8"  | 1-3/8"   |
| GCM2502M | 133 | PANEL MLDG | 1"      | 1-3/4"   |
| GCM302   | 133 | PANEL MLDG | 1-1/16" | 2-3/4"   |
| GCM4002  | 133 | PANEL MLDG | 1"      | 1-3/8"   |
| GCM428   | 133 | PANEL MLDG | 3/4"    | 1-3/8"   |
| GCM5501  | 133 | PANEL MLDG | 3/4"    | 1-1/2"   |
| GCM5502  | 133 | PANEL MLDG | 1-3/8"  | 1-3/16"  |
| GCM5512  | 133 | PANEL MLDG | 15/16"  | 1-1/2"   |
| GCM6056  | 133 | PANEL MLDG | 1-1/8"  | 2-1/4"   |
| GCM1036  | 134 | PANEL MLDG | 1-1/4"  | 3"       |
| GCM1104  | 134 | PANEL MLDG | 1-3/4"  | 3-3/8"   |

# PROFILE INDEX

|             |     |            |          |         |
|-------------|-----|------------|----------|---------|
| GCM1382     | 134 | PANEL MLDG | 2-1/8"   | 3-3/8"  |
| GCM305      | 134 | PANEL MLDG | 1-1/2"   | 2-1/2"  |
| GCM8282     | 134 | PANEL MLDG | 1-3/8"   | 2-3/4"  |
| GCM788      | 134 | PANEL MLDG | 1-5/16"  | 3"      |
| GCM6934     | 135 | PANEL MLDG | 1-13/32" | 2-1/16" |
| GCM1622     | 135 | PANEL MLDG | 1-13/16" | 2-3/4"  |
| GCM578      | 135 | PANEL MLDG | 1-5/8"   | 3-1/16" |
| GCM6054     | 135 | PANEL MLDG | 1-1/2"   | 3-1/2"  |
| GCM3504     | 136 | T&G        | 3/4"     | VARIES  |
| GCM3508     | 136 | T&G        | 3/4"     | VARIES  |
| GCM3509     | 136 | T&G        | 1"       | VARIES  |
| GCM3512     | 136 | T&G        | 3/4"     | VARIES  |
| GCM3521     | 136 | T&G        | TO 2"    | VARIES  |
| GCM3502     | 137 | T&G        | 3/4"     | VARIES  |
| GCM3511     | 137 | T&G        | 1/2"     | VARIES  |
| GCM3523     | 137 | T&G        | 3/4"     | VARIES  |
| GCM3524     | 137 | T&G        | 1/2"     | VARIES  |
| GCM3528     | 137 | T&G        |          |         |
| GCM3103     | 138 | T&G        | 3/4"     | VARIES  |
| GCM3510     | 138 | T&G        | 3/4"     | 5-1/2"  |
| GCM3514     | 138 | T&G        | 1/2"     | VARIES  |
| GCM3518     | 138 | T&G        | 3/4"     | VARIES  |
| GCM3527     | 138 | T&G        | 3/4"     | 5-3/16" |
| GCM7509     | 139 | T&G        | 11/16"   | 6-7/8"  |
| GCM3531     | 139 | T&G        | 1-1/4"   | VARIES  |
| GCM7510     | 139 | T&G        | 3/4"     | 7-1/4"  |
| GCM3503     | 140 | T&G        | 13/16"   | 4-1/4"  |
| GCM3506     | 140 | T&G        | 3/4"     | 5-1/2"  |
| GCM3517     | 140 | T&G        | 3/4"     | VARIES  |
| GCM3520     | 140 | T&G        | 3/4"     | 3-1/4"  |
| GCMS110 3.5 | 140 | T&G        | 7/16"    | 3-1/2"  |
| GCMS110 5.5 | 140 | T&G        | 7/16"    | 5-1/2"  |
| GCM3505     | 141 | T&G        | 3/4"     | VARIES  |
| GCM3507     | 141 | T&G        | 3/4"     | VARIES  |
| GCM3526     | 141 | T&G        | 3/4"     | VARIES  |
| GCMSL850    | 141 | T&G        | 3/4"     | VARIES  |
| GCM3515     | 142 | T&G        | 3/4"     | VARIES  |
| GCM3519     | 142 | T&G        | 3/4"     | VARIES  |
| GCM3522     | 142 | T&G        | 3/4"     | VARIES  |
| GCM3525     | 142 | T&G        | 3/8"     | VARIES  |
| GCM7501     | 142 | T&G        | 3/4"     | VARIES  |
| GCM121      | 143 | T&G        | 23/32"   | VARIES  |
| GCM3501     | 143 | T&G        | 3/4"     | 7-3/4"  |
| GCM3516     | 143 | T&G        | 1"       | VARIES  |
| GCM7500     | 143 | T&G        | 3/4"     | 7-1/2"  |
| GCMSL525    | 143 | T&G        | 3/4"     | 5-1/4"  |
| GCM145      | 144 | SIDING     | 3/4"     | 9-1/4"  |

# PROFILE INDEX

|         |     |           |         |          |
|---------|-----|-----------|---------|----------|
| GCM7503 | 144 | SIDING    | 3/4"    | 7-1/4"   |
| GCM7506 | 144 | SIDING    | 1/2"    | 7-1/4"   |
| GCM7504 | 144 | SIDING    | 3/4"    | 4-11/16" |
| GCM7505 | 144 | SIDING    | 3/4"    | 5-9/16"  |
| GCM145  | 144 | T&G       | 3/4"    | 7-1/4"   |
| GCM119  | 145 | SIDING    | 23/32"  | 5-3/8"   |
| GCM7511 | 145 | SIDING    | 3/4"    | VARIES   |
| GCM12   | 147 | CHAIRRAIL | 5/8"    | 2-7/16"  |
| GCM9548 | 149 | DOOR      | 2-1/4"  |          |
| GCM1361 | 150 | CHAIRRAIL | 1-1/2"  | 3-1/4"   |
| GCM20   | 150 | CHAIRRAIL | 1-1/2"  | 5-1/2"   |
| GCM300  | 150 | CHAIRRAIL | 1-1/16" | 2-3/4"   |
| GCM304  | 150 | CHAIRRAIL | 9/16"   | 4-1/4"   |
| GCM395  | 150 | CHAIRRAIL | 1"      | 4"       |
| GCM1022 | 151 | CHAIRRAIL | 1"      | 4"       |
| GCM302  | 151 | CHAIRRAIL | 1-1/16" | 2-3/4"   |
| GCM5003 | 151 | CHAIRRAIL | 1-1/2"  | 3-1/2"   |

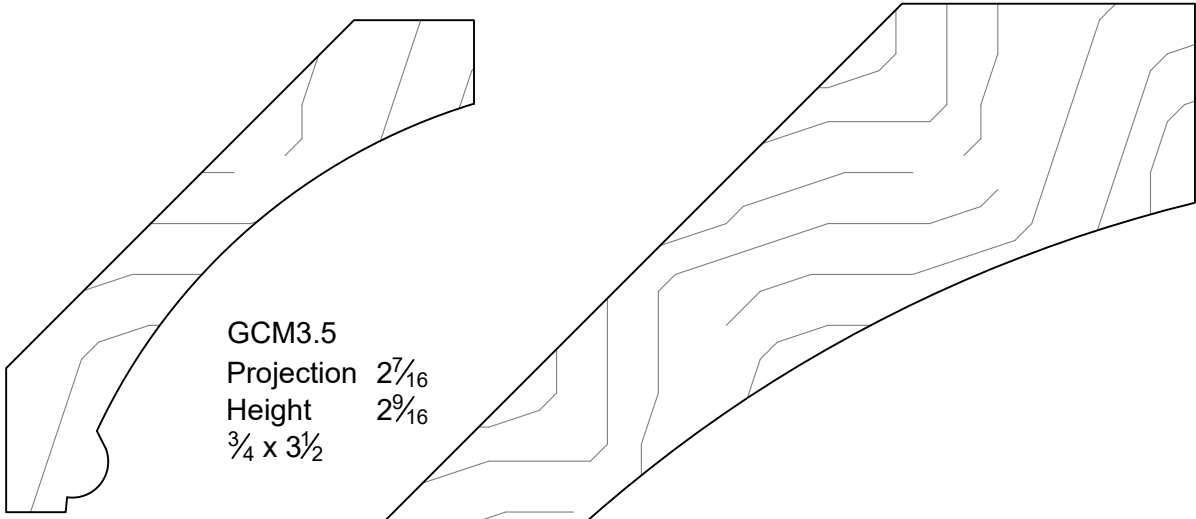

GCM3.5  
 Projection  $2\frac{7}{16}$   
 Height  $2\frac{9}{16}$   
 $\frac{3}{4} \times 3\frac{1}{2}$

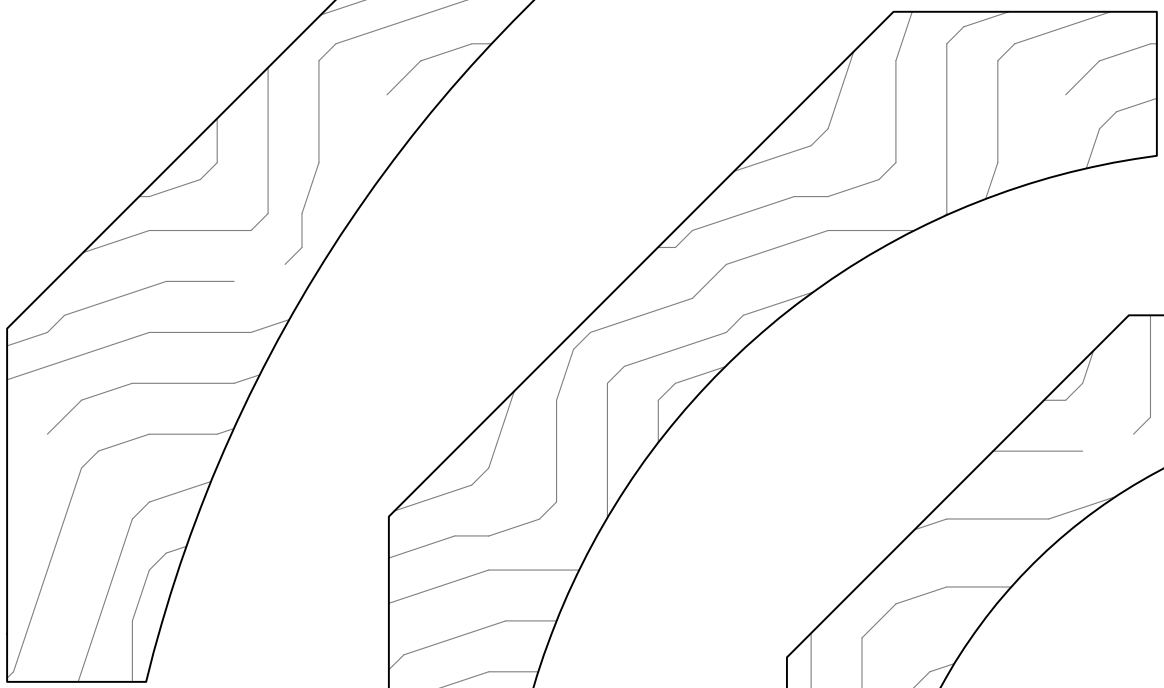

GCM1509  
 Projection  $6\frac{3}{16}$   
 Height  $6\frac{1}{2}$   
 $1\frac{3}{4} \times 9$

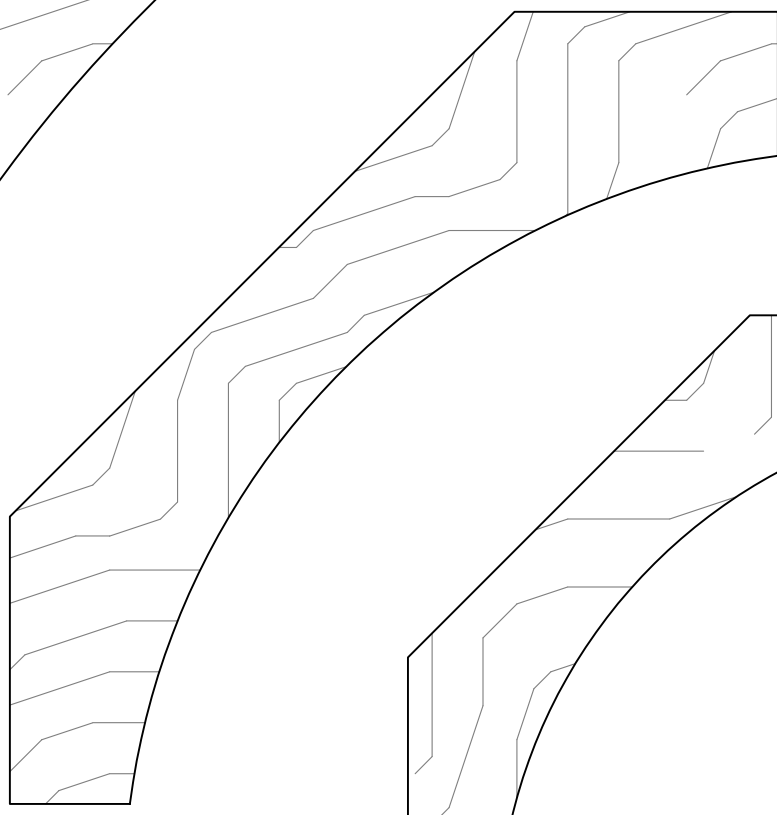

GCM1212  
 Projection 4  
 Height  $4\frac{1}{8}$   
 $1\frac{1}{2} \times 5\frac{3}{4}$

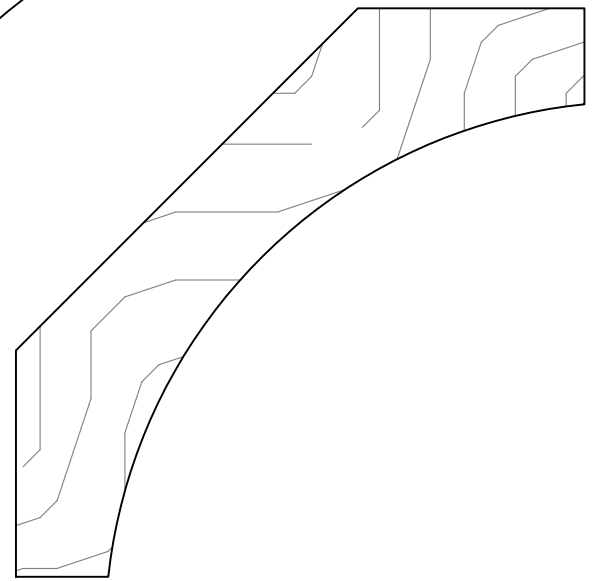

GCM795  
 Projection 3  
 Height 3  
 $1\frac{1}{4} \times 4\frac{1}{4}$

# GRAYCO BUILDING CENTER

WWW.GRAYCOINC.COM

BLUFFTON  
 345 BUCK ISLAND RD, BLUFFTON SC 29910  
 (843) 815-5788 FAX 815-5799

LADY'S ISLAND  
 20 SAMS POINT WAY, BEAUFORT SC 29907  
 (843) 522-9994 FAX 522-9972



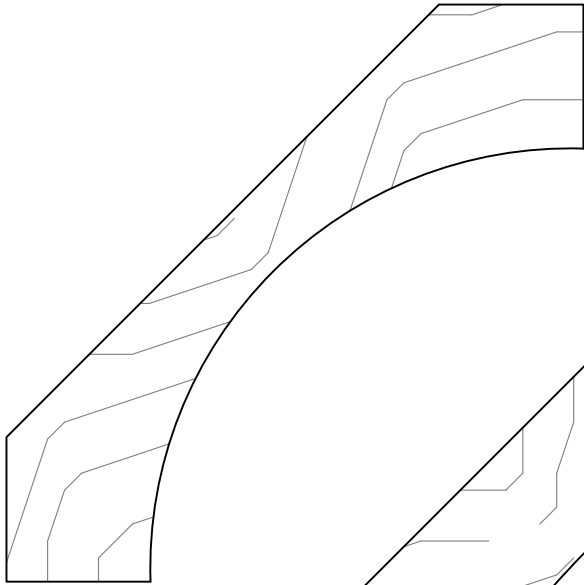

GCM575  
Projection 3  
Height 3  
1 1/16 X 4 1/4

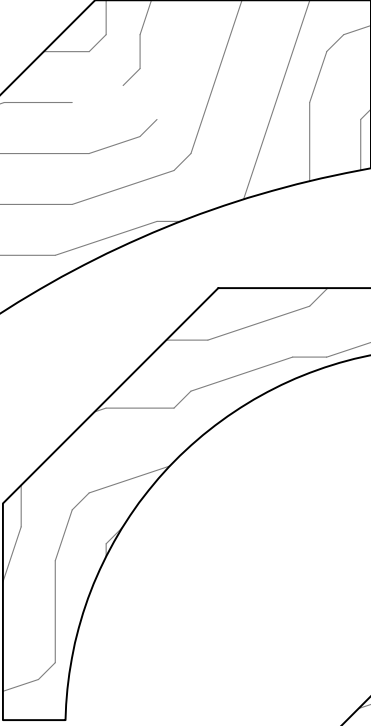

GCM610  
Projection 2 5/16  
Height 2 1/4  
1 1/16 X 3 1/4

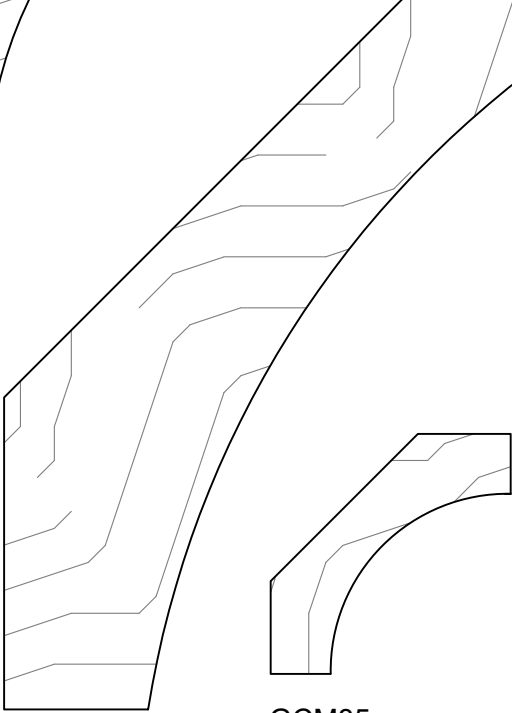

GCM1076  
Projection 5  
Height 5 3/16  
1 3/4 X 7 3/16

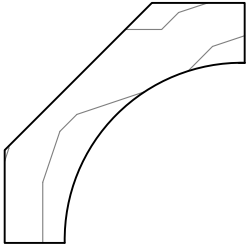

GCM85  
Projection 1 1/4  
Height 1 1/4  
9/16 X 1 3/4

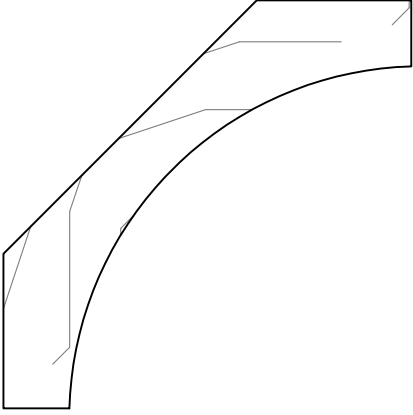

GCM30  
Projection 2 1/8  
Height 2 1/8  
1 3/16 X 3

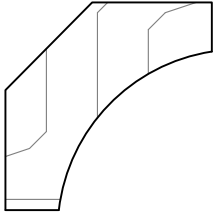

GCM86  
Projection 1 1/16  
Height 1 1/16  
5/8 X 1 1/2

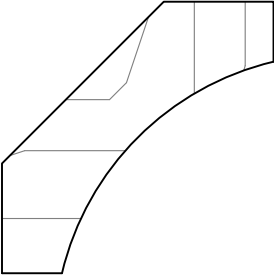

GCM81  
Projection 1 13/32  
Height 1 13/32  
5/8 X 2

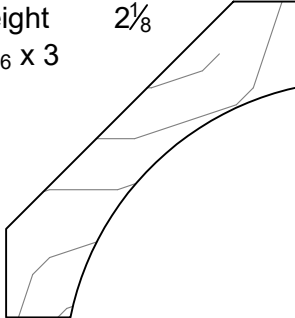

GCM84  
PROJECTION 1 1/2"  
HEIGHT 1 1/16"  
9/16 X 2 1/4

# GRAYCO BUILDING CENTER

WWW.GRAYCOINC.COM

BLUFFTON  
345 BUCK ISLAND RD, BLUFFTON SC 29910  
(843) 815-5788 FAX 815-5799

LADY'S ISLAND  
20 SAMS POINT WAY, BEAUFORT SC 29907  
(843) 522-9994 FAX 522-9972

GCM K  
Projection  $3\frac{15}{16}$   
Height  $3\frac{15}{16}$   
 $1\frac{1}{8} \times 5\frac{9}{16}$

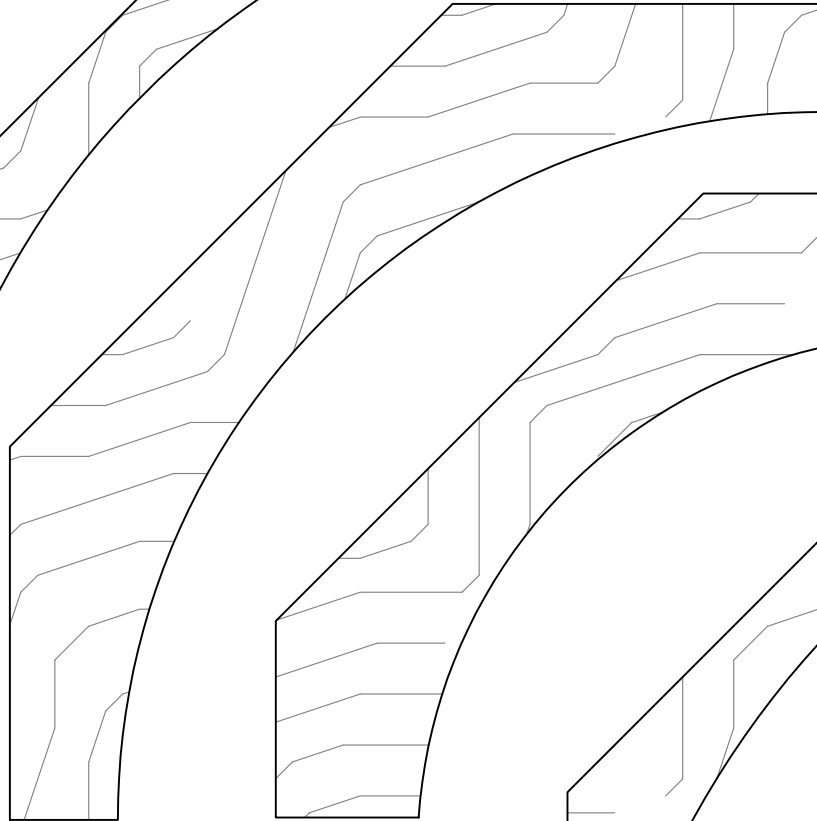
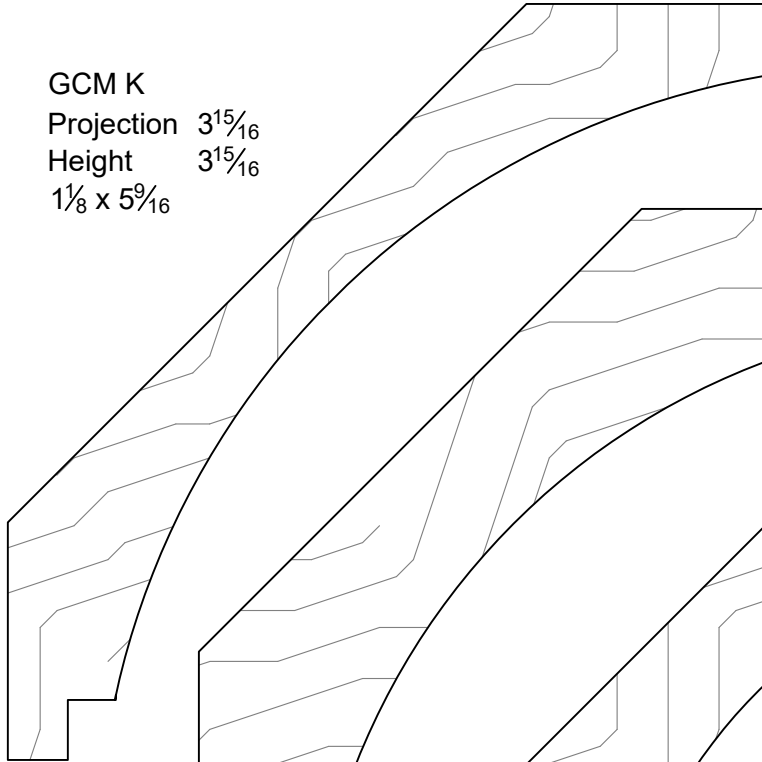

GCM1213  
Projection  $4\frac{1}{4}$   
Height  $4\frac{1}{4}$   
 $1\frac{3}{4} \times 6$

GCM609  
Projection  $3\frac{3}{16}$   
Height  $3\frac{1}{4}$   
 $1\frac{1}{4} \times 4\frac{9}{16}$

GCM1266  
Projection  $3\frac{3}{16}$   
Height  $3\frac{3}{16}$   
 $1\frac{3}{16} \times 4\frac{1}{2}$

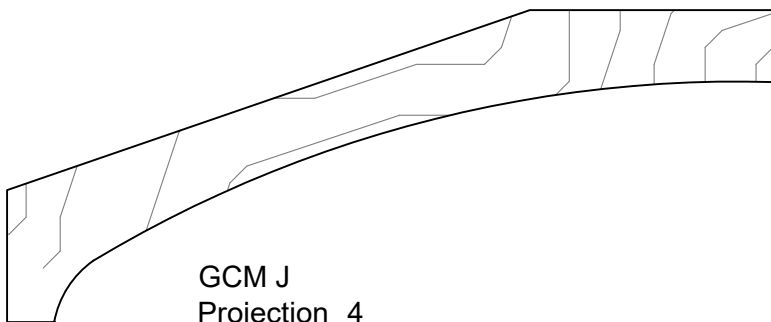
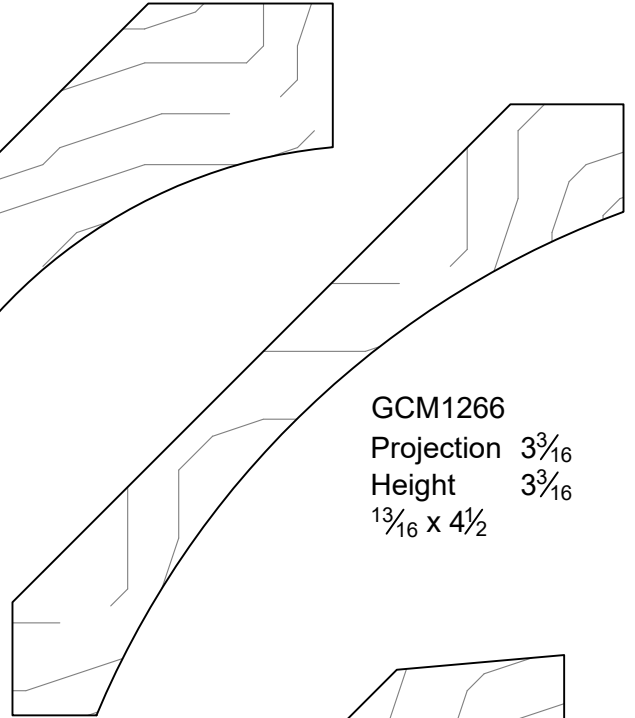

GCM J  
Projection 4  
Height  $1\frac{5}{8}$   
 $1\frac{3}{16} \times 4\frac{5}{16}$



GCM40358  
Projection  $2\frac{5}{8}$   
Height  $2\frac{1}{2}$   
 $\frac{3}{4} \times 3\frac{5}{8}$

# GRAYCO BUILDING CENTER

WWW.GRAYCOINC.COM

BLUFFTON  
345 BUCK ISLAND RD, BLUFFTON SC 29910  
(843) 815-5788 FAX 815-5799

LADY'S ISLAND  
20 SAMS POINT WAY, BEAUFORT SC 29907  
(843) 522-9994 FAX 522-9972

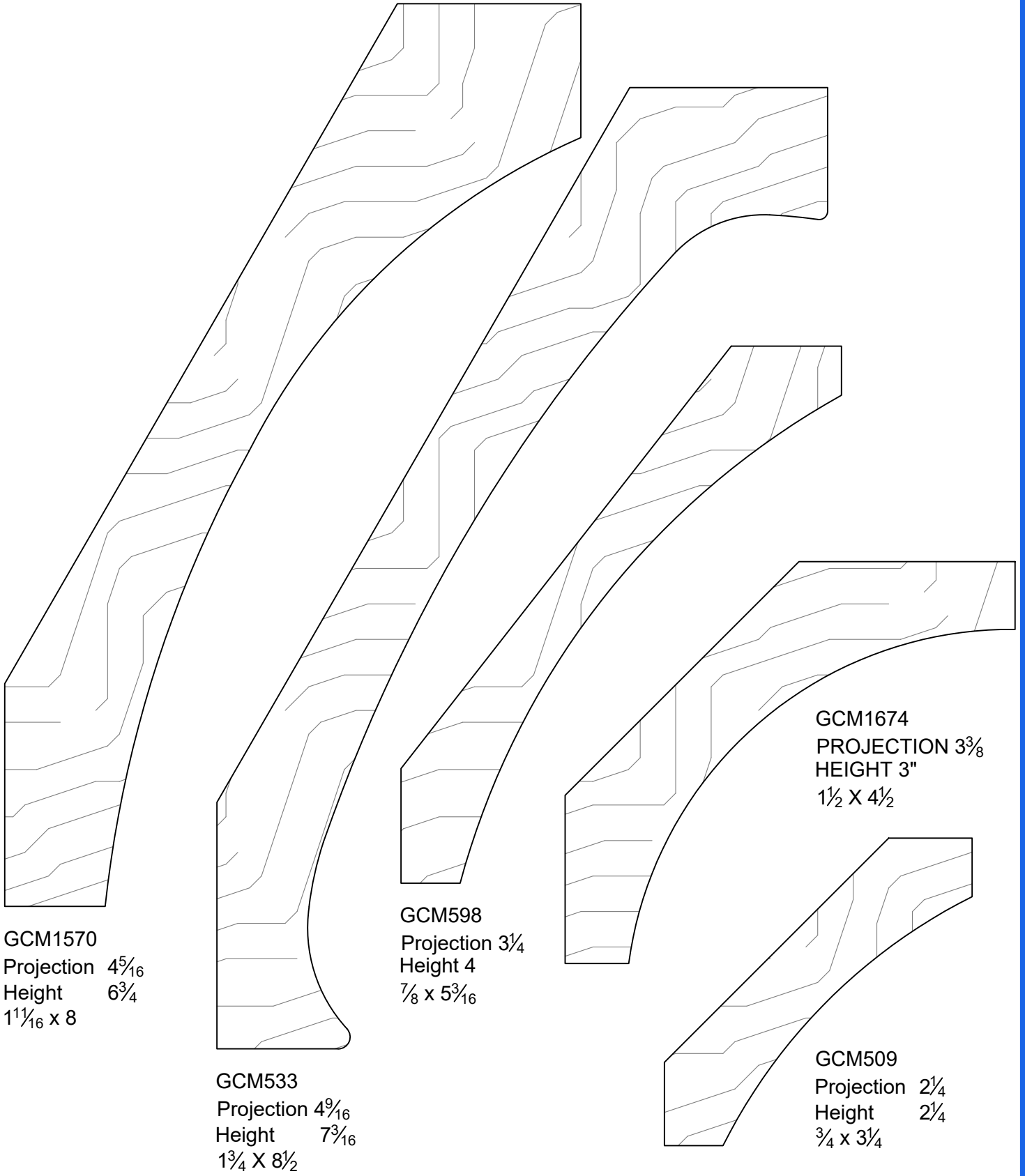

GCM1570  
 Projection  $4\frac{5}{16}$   
 Height  $6\frac{3}{4}$   
 $1\frac{1}{16} \times 8$

GCM533  
 Projection  $4\frac{9}{16}$   
 Height  $7\frac{3}{16}$   
 $1\frac{3}{4} \times 8\frac{1}{2}$

GCM598  
 Projection  $3\frac{1}{4}$   
 Height 4  
 $\frac{7}{8} \times 5\frac{3}{16}$

GCM1674  
 PROJECTION  $3\frac{3}{8}$   
 HEIGHT 3"  
 $1\frac{1}{2} \times 4\frac{1}{2}$

GCM509  
 Projection  $2\frac{1}{4}$   
 Height  $2\frac{1}{4}$   
 $\frac{3}{4} \times 3\frac{1}{4}$

# GRAYCO BUILDING CENTER

WWW.GRAYCOINC.COM

BLUFFTON  
 345 BUCK ISLAND RD, BLUFFTON SC 29910  
 (843) 815-5788 FAX 815-5799

LADY'S ISLAND  
 20 SAMS POINT WAY, BEAUFORT SC 29907  
 (843) 522-9994 FAX 522-9972

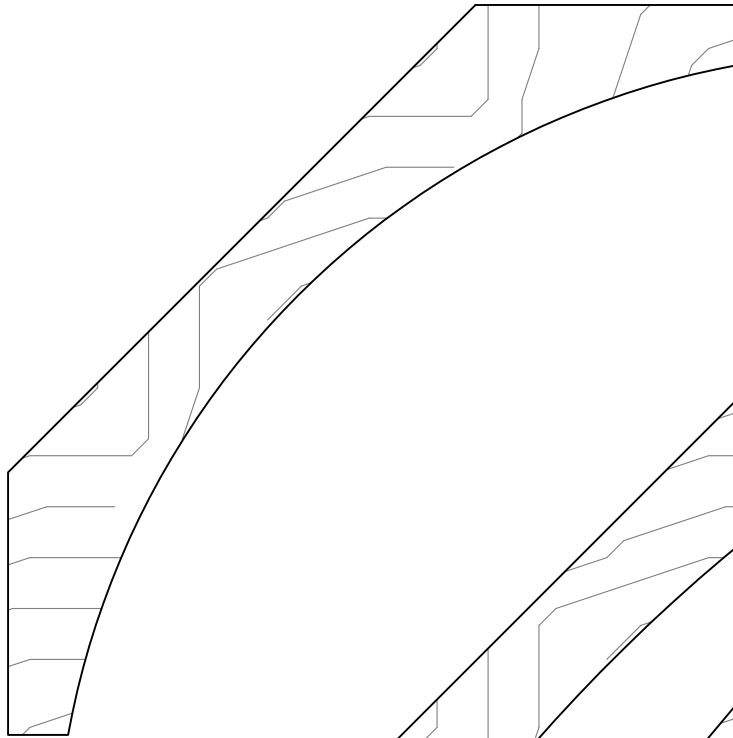

GCM517  
 Projection  $3\frac{1}{16}$   
 Height  $3\frac{1}{16}$   
 $1\frac{3}{16} \times 5\frac{3}{8}$

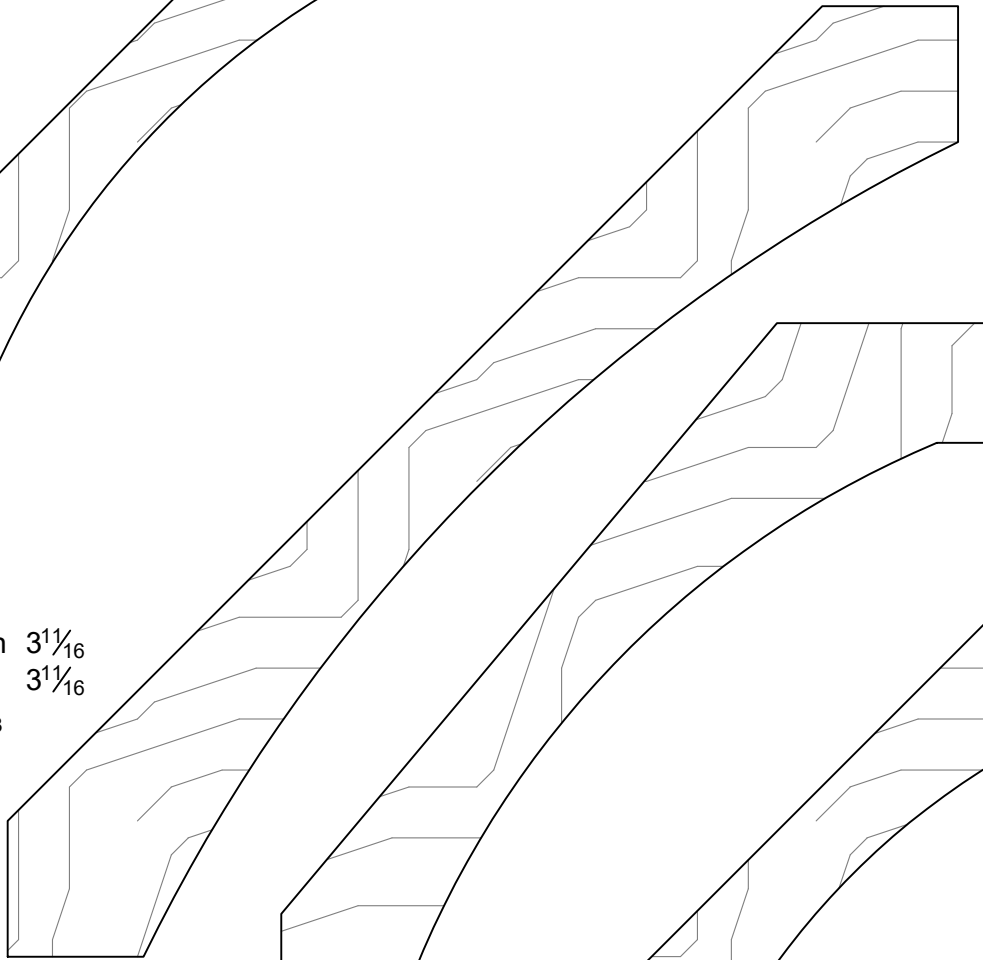

GCM3661  
 Projection  $4\frac{15}{16}$   
 Height  $4\frac{15}{16}$   
 1 x 7

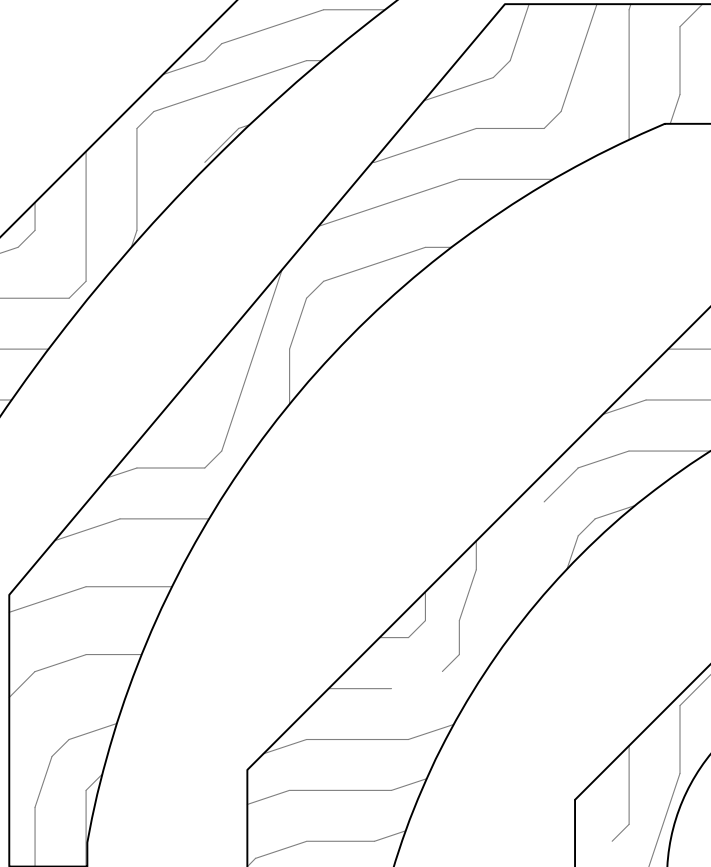

GCM611  
 Projection  $3\frac{1}{16}$   
 Height  $4\frac{1}{2}$   
 $1\frac{1}{4} \times 5\frac{3}{16}$

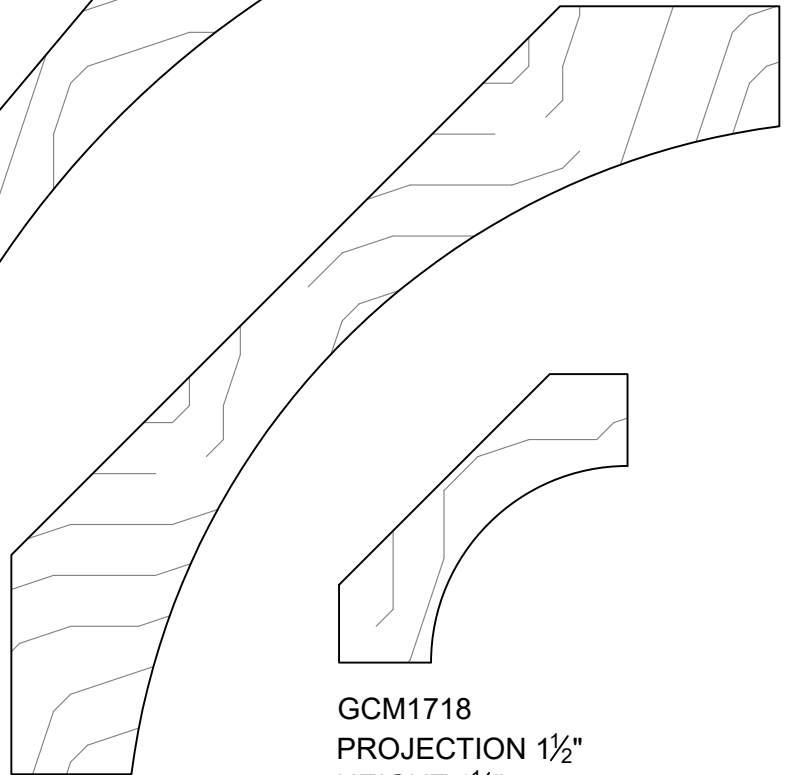

GCM1210  
 Projection 4  
 Height 4  
 $1\frac{1}{4} \times 5\frac{5}{8}$

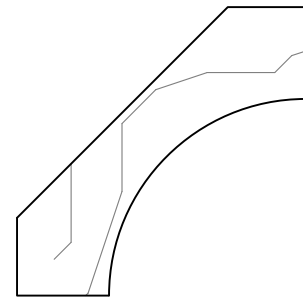

GCM1718  
 PROJECTION  $1\frac{1}{2}$ "  
 HEIGHT  $1\frac{1}{2}$ "  
 $\frac{5}{8} \times 2\frac{1}{8}$ "

# GRAYCO BUILDING CENTER

WWW.GRAYCOINC.COM

BLUFFTON  
 345 BUCK ISLAND RD, BLUFFTON SC 29910  
 (843) 815-5788 FAX 815-5799

LADY'S ISLAND  
 20 SAMS POINT WAY, BEAUFORT SC 29907  
 (843) 522-9994 FAX 522-9972

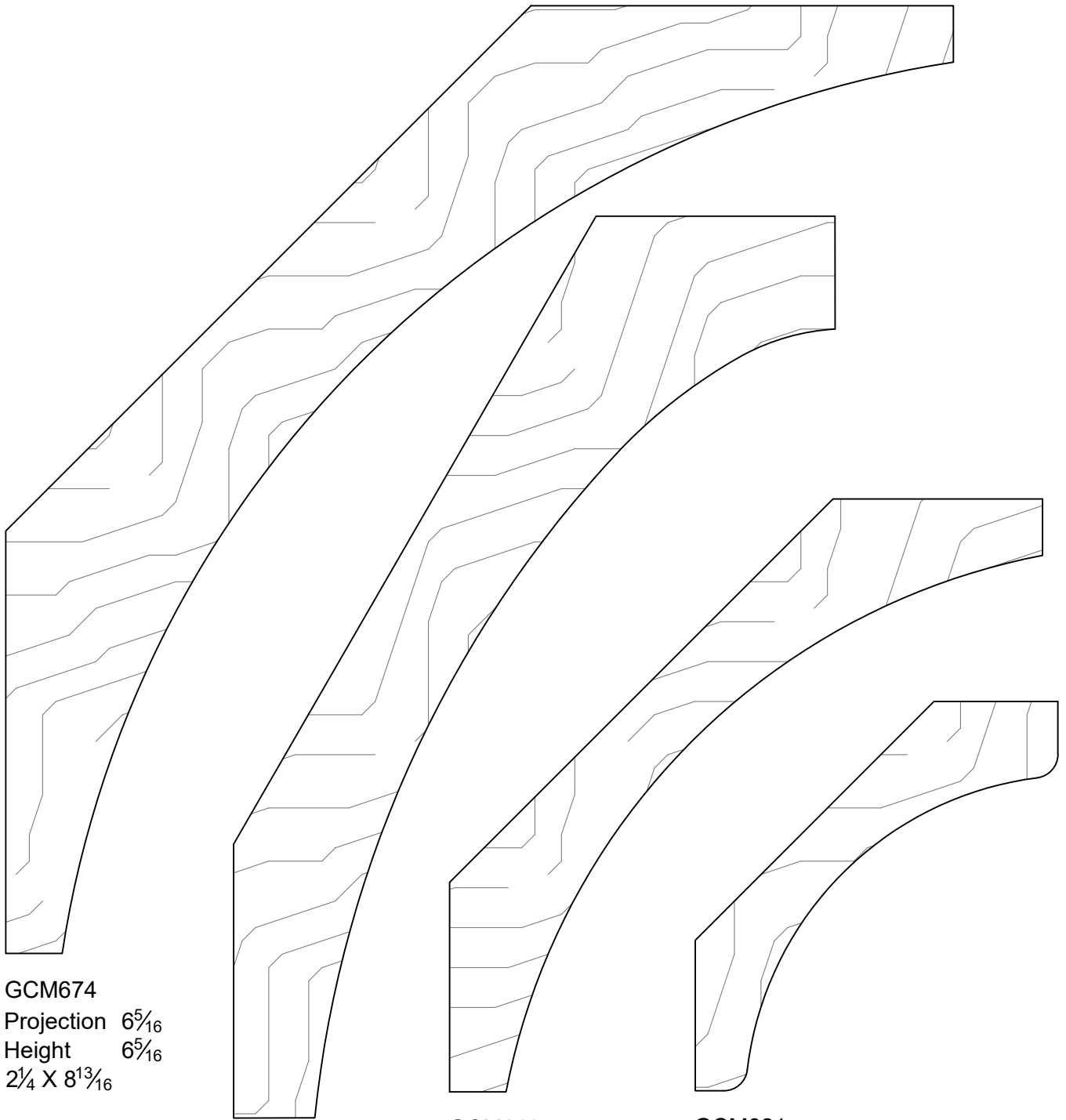

GCM674  
 Projection  $6\frac{5}{16}$   
 Height  $6\frac{5}{16}$   
 $2\frac{1}{4} \times 8\frac{13}{16}$

GCM1106  
 Projection 4  
 Height 6  
 $1\frac{3}{4} \times 7\frac{3}{16}$

GCM619  
 PROJECTION  $3\frac{15}{16}$ "  
 HEIGHT  $3\frac{15}{16}$ "  
 $1\frac{1}{4} \times 5\frac{9}{16}$ "

GCM621  
 Projection  $2\frac{7}{16}$   
 Height  $2\frac{9}{16}$   
 $\frac{7}{8} \times 3\frac{1}{2}$

# GRAYCO BUILDING CENTER

WWW.GRAYCOINC.COM

BLUFFTON  
 345 BUCK ISLAND RD, BLUFFTON SC 29910  
 (843) 815-5788 FAX 815-5799

LADY'S ISLAND  
 20 SAMS POINT WAY, BEAUFORT SC 29907  
 (843) 522-9994 FAX 522-9972

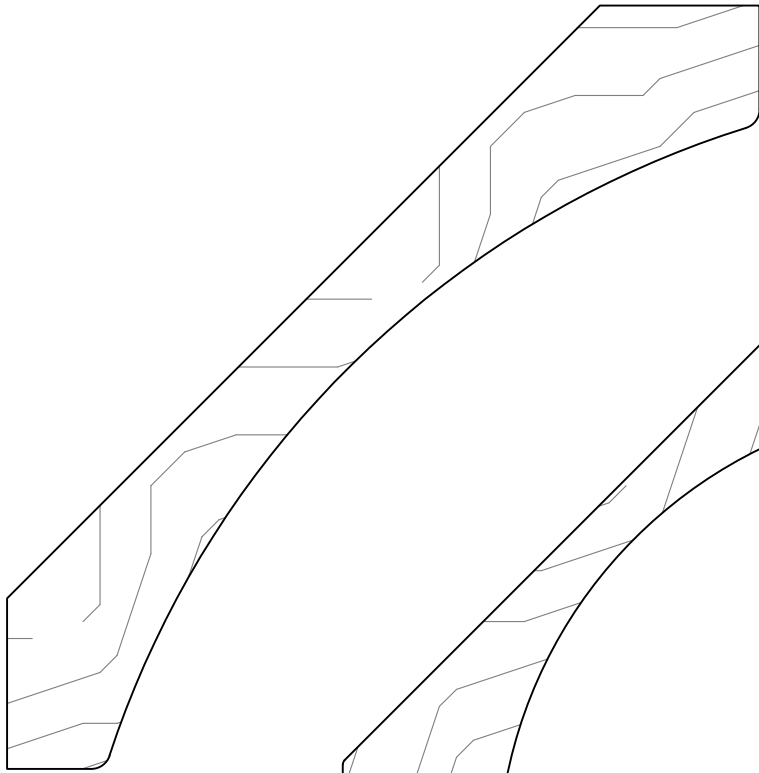

GCM623  
 Projection  $3\frac{15}{16}$   
 Height  $3\frac{15}{16}$   
 1 X  $5\frac{5}{8}$

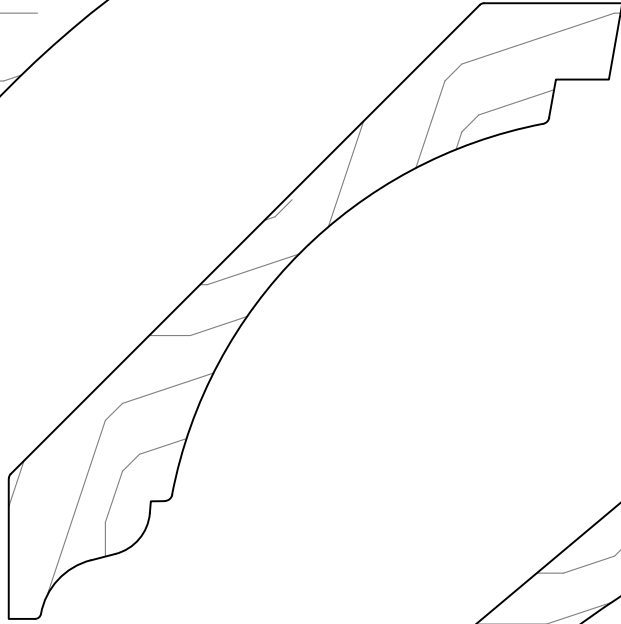

GCM626  
 Projection  $3\frac{3}{16}$   
 Height  $3\frac{1}{4}$   
 $\frac{3}{4}$  X  $4\frac{1}{2}$

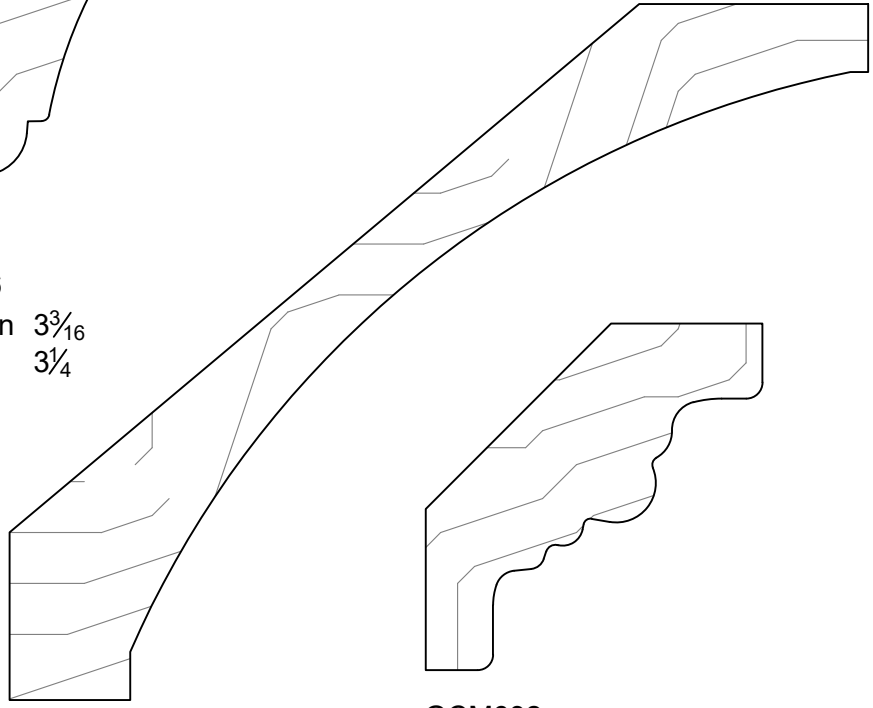

GCM1173  
 Projection  $4\frac{1}{2}$   
 Height  $3\frac{5}{8}$   
 $1\frac{1}{16}$  X  $5\frac{3}{4}$

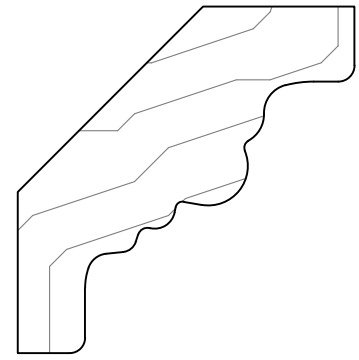

GCM632  
 Projection  $1\frac{13}{16}$   
 Height  $1\frac{3}{4}$   
 $\frac{13}{16}$  X  $2\frac{1}{2}$

# GRAYCO BUILDING CENTER

WWW.GRAYCOINC.COM

BLUFFTON  
 345 BUCK ISLAND RD, BLUFFTON SC 29910  
 (843) 815-5788 FAX 815-5799

LADY'S ISLAND  
 20 SAMS POINT WAY, BEAUFORT SC 29907  
 (843) 522-9994 FAX 522-9972



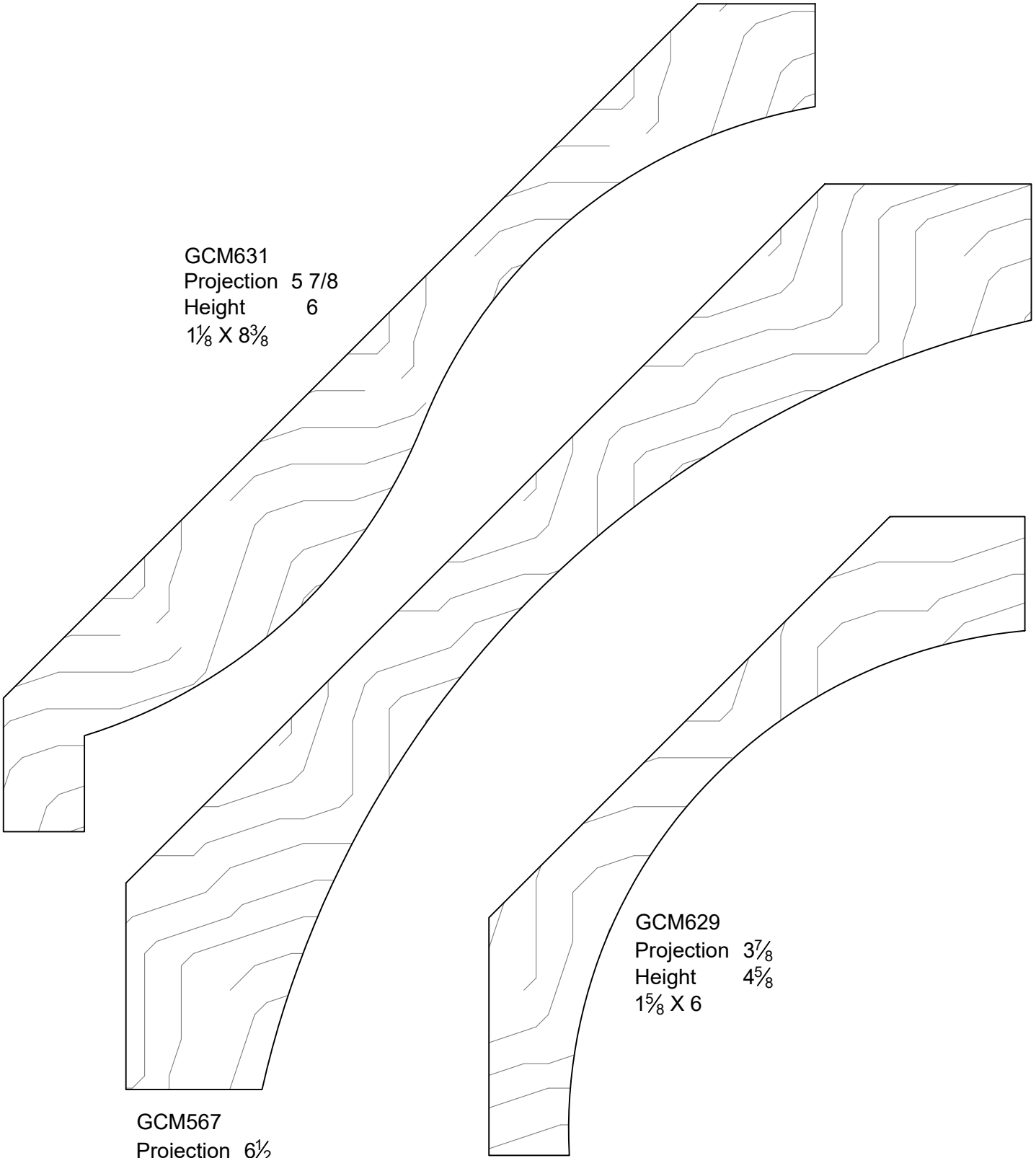

GCM631  
Projection 5 7/8  
Height 6  
1 1/8 X 8 3/8

GCM629  
Projection 3 7/8  
Height 4 5/8  
1 5/8 X 6

GCM567  
Projection 6 1/2  
Height 6 1/2  
1 3/4 X 9 1/4"

# GRAYCO BUILDING CENTER

WWW.GRAYCOINC.COM

BLUFFTON  
345 BUCK ISLAND RD, BLUFFTON SC 29910  
(843) 815-5788 FAX 815-5799

LADY'S ISLAND  
20 SAMS POINT WAY, BEAUFORT SC 29907  
(843) 522-9994 FAX 522-9972

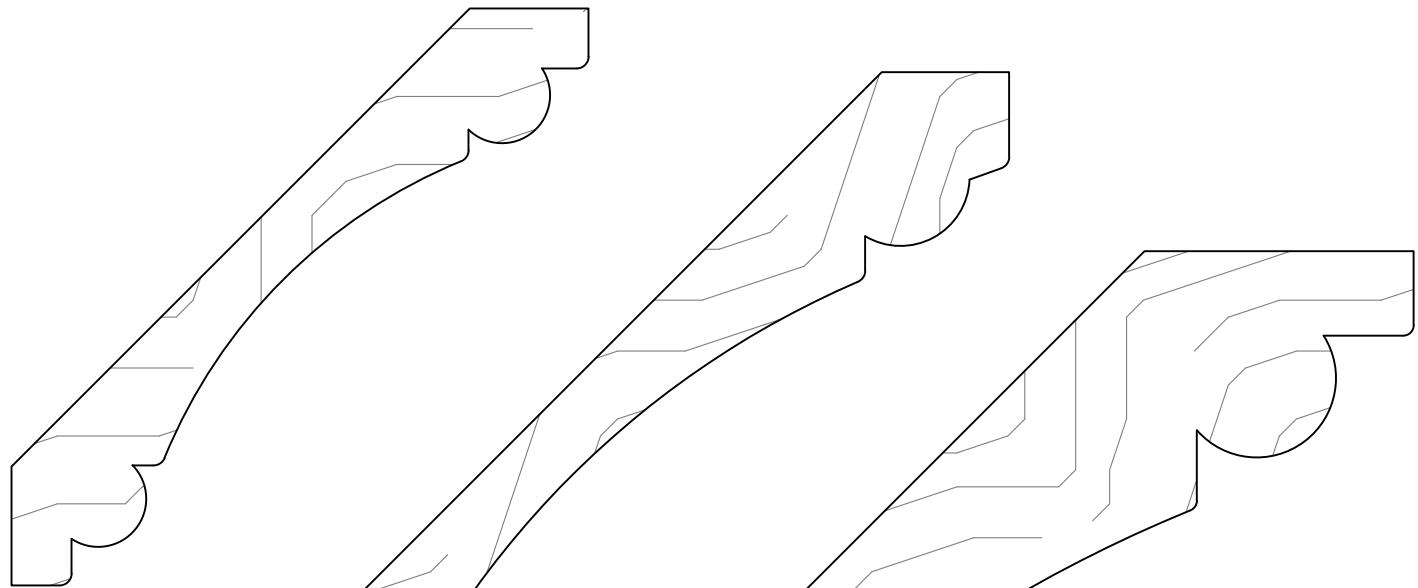

GCM334  
 Projection 3  
 Height 3  
 $1\frac{1}{16} \times 4\frac{1}{4}$

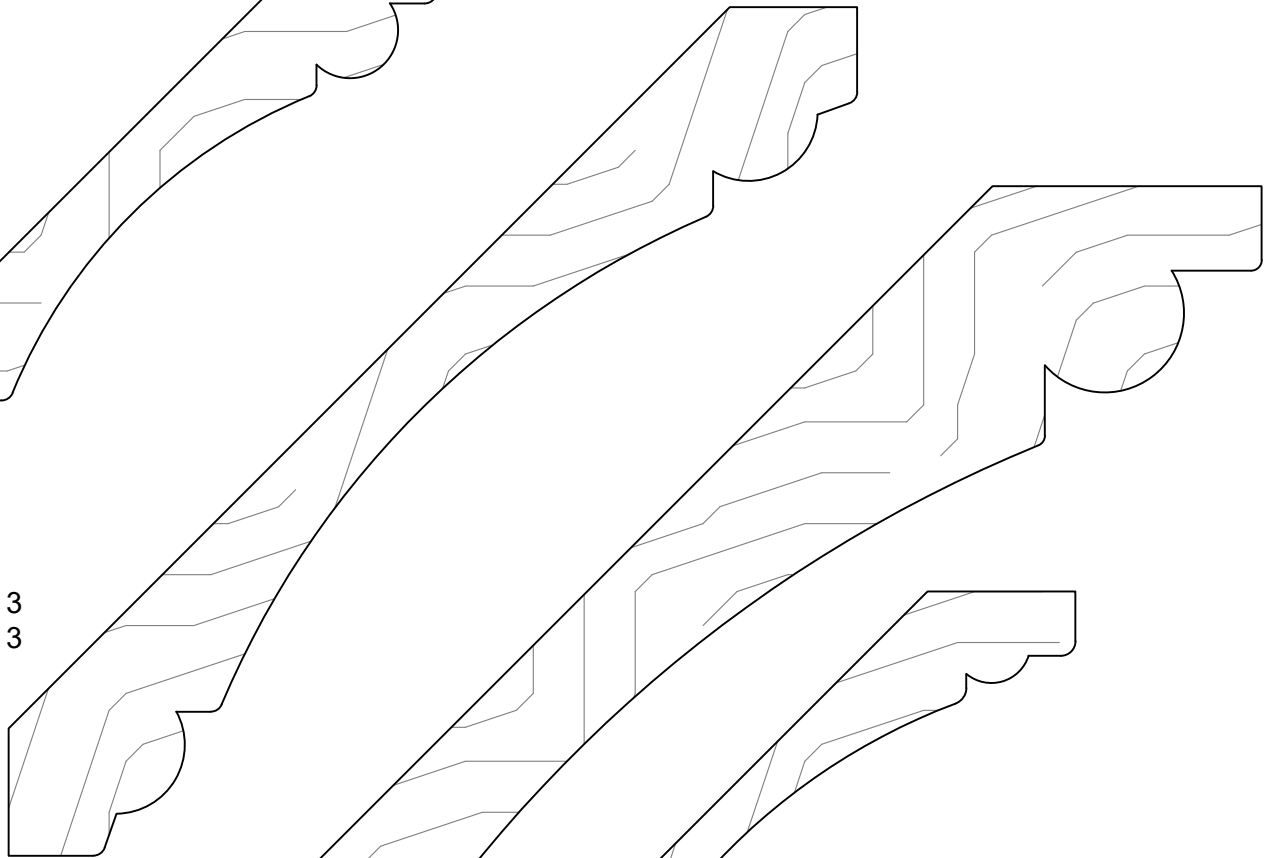

GCM335  
 Projection  $4\frac{13}{32}$   
 Height  $4\frac{13}{32}$   
 $1\frac{3}{16} \times 6\frac{1}{4}$

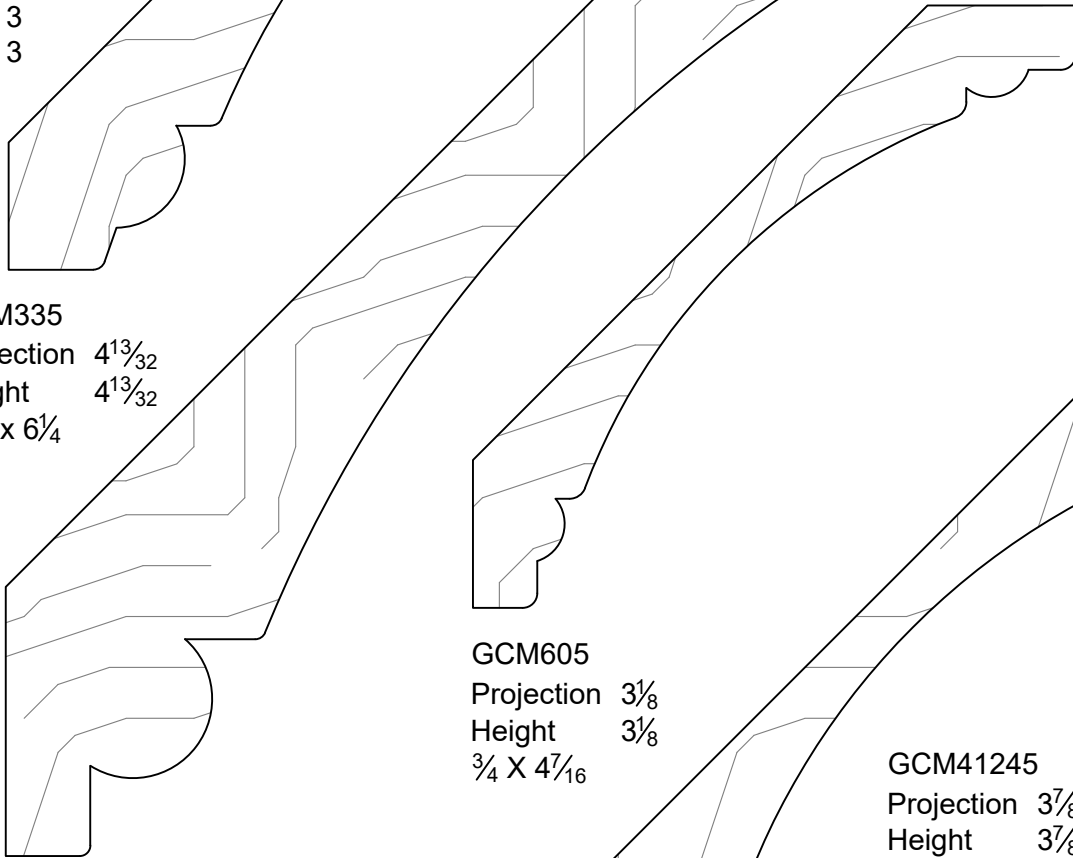

GCM605  
 Projection  $\frac{3}{8}$   
 Height  $\frac{3}{8}$   
 $\frac{3}{4} \times 4\frac{7}{16}$

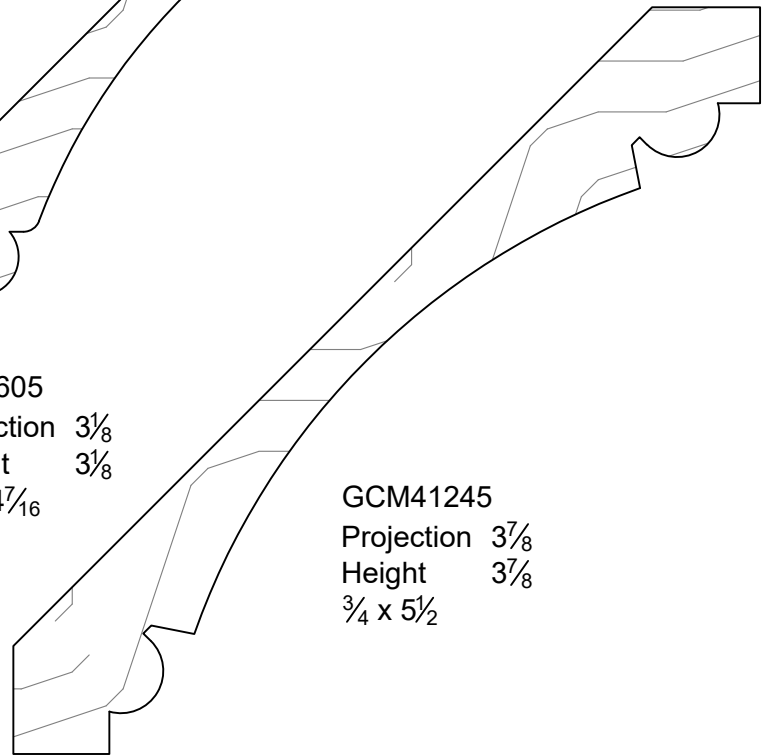

GCM41245  
 Projection  $\frac{3}{8}$   
 Height  $\frac{3}{8}$   
 $\frac{3}{4} \times 5\frac{1}{2}$

GCM566  
 Projection  $6\frac{1}{2}$   
 Height  $6\frac{1}{2}$   
 $1\frac{1}{4} \times 9\frac{1}{4}$

# GRAYCO BUILDING CENTER

WWW.GRAYCOINC.COM

BLUFFTON  
 345 BUCK ISLAND RD, BLUFFTON SC 29910  
 (843) 815-5788 FAX 815-5799

LADY'S ISLAND  
 20 SAMS POINT WAY, BEAUFORT SC 29907  
 (843) 522-9994 FAX 522-9972

GCM41  
Projection  $3\frac{1}{16}$ "  
Height  $3\frac{1}{16}$ "  
 $\frac{3}{4} \times 5\frac{1}{4}$

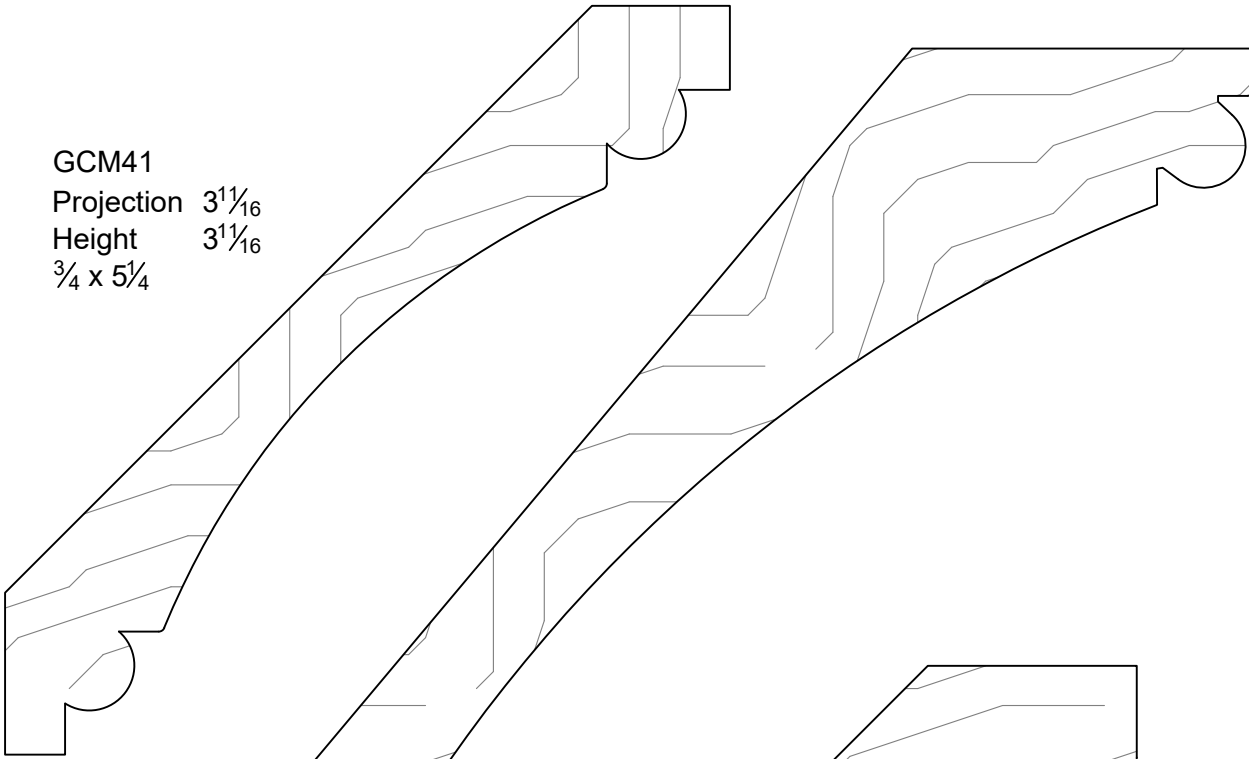

GCM541  
PROJECTION  $6\frac{1}{4}$ "  
HEIGHT  $7\frac{3}{8}$ "  
 $1\frac{3}{4} \times 9\frac{1}{16}$

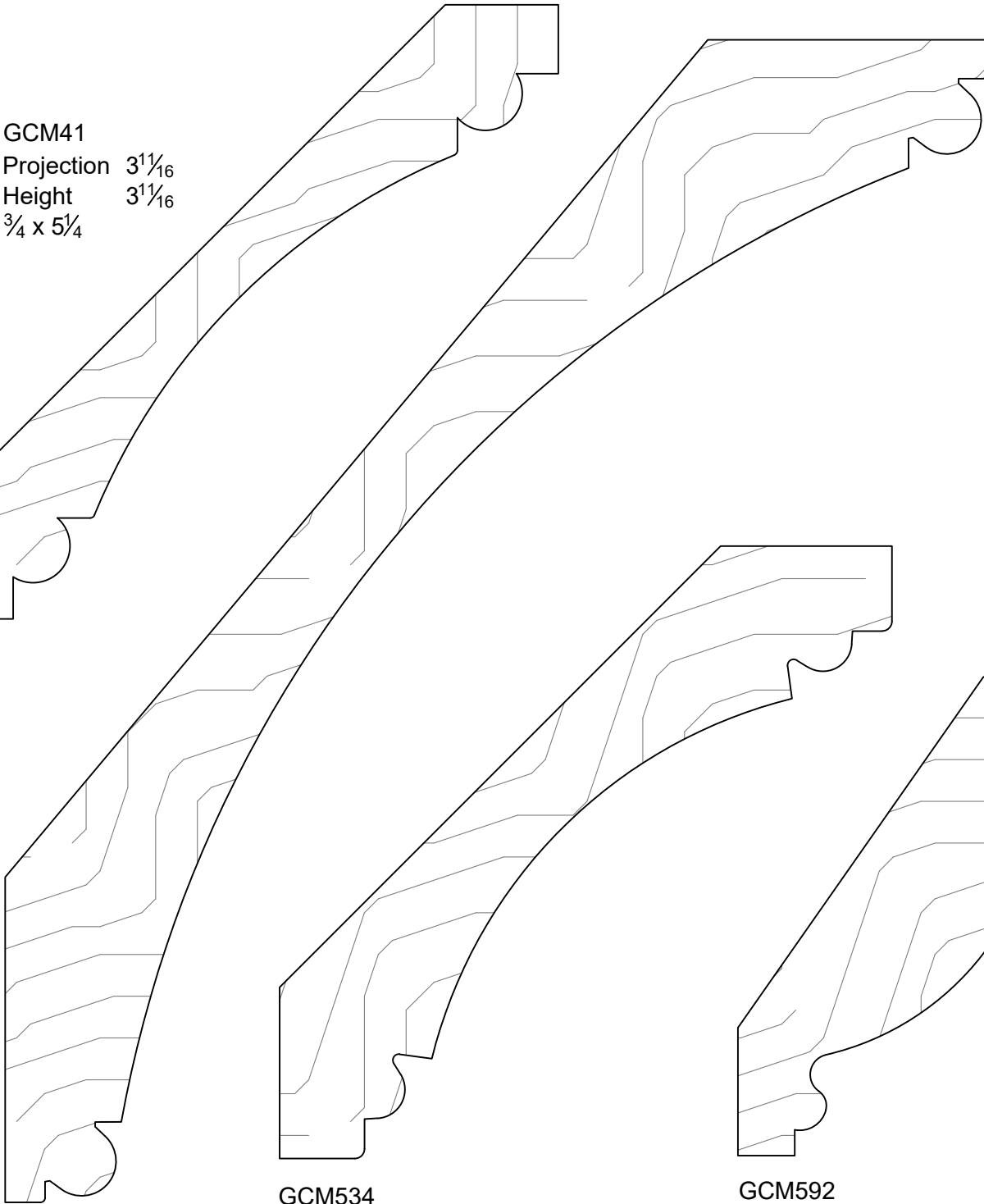

GCM534  
PROJECTION  $3\frac{7}{8}$ "  
HEIGHT  $3\frac{7}{8}$ "  
 $1\frac{1}{8} \times 5\frac{1}{2}$

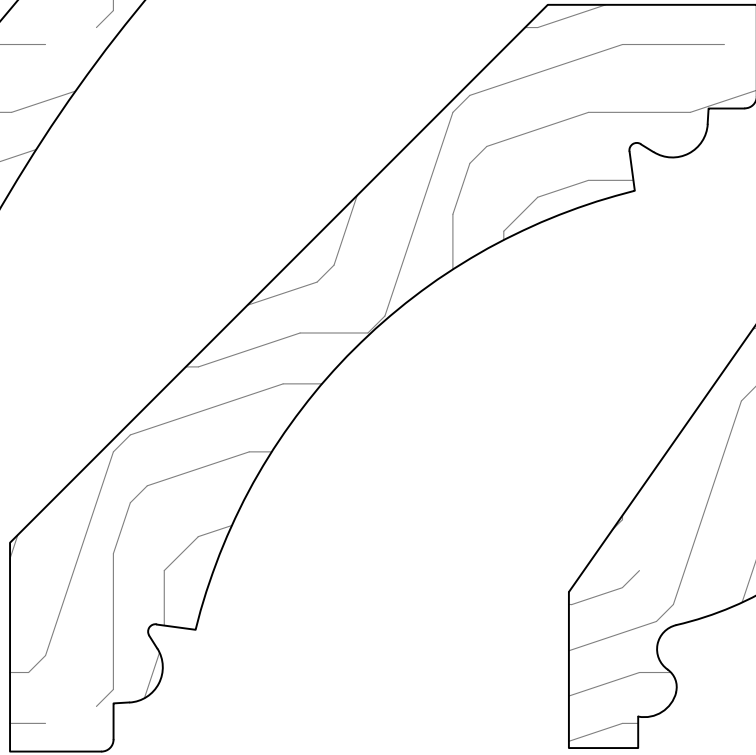

GCM592  
PROJECTION  $2\frac{1}{4}$ "  
HEIGHT 3"  
 $1 \times 3\frac{7}{8}$

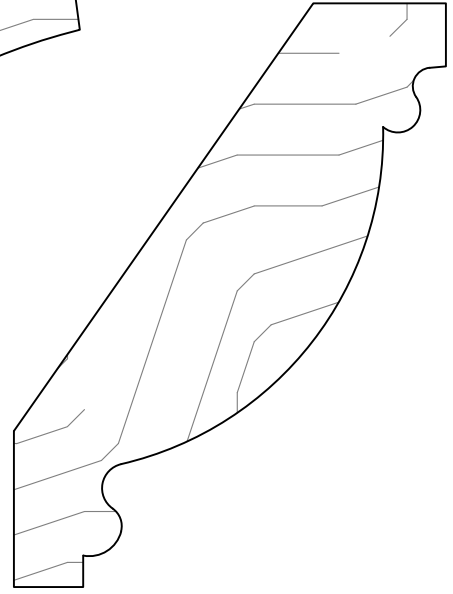

# GRAYCO BUILDING CENTER

WWW.GRAYCOINC.COM

BLUFFTON  
345 BUCK ISLAND RD, BLUFFTON SC 29910  
(843) 815-5788 FAX 815-5799

LADY'S ISLAND  
20 SAMS POINT WAY, BEAUFORT SC 29907  
(843) 522-9994 FAX 522-9972

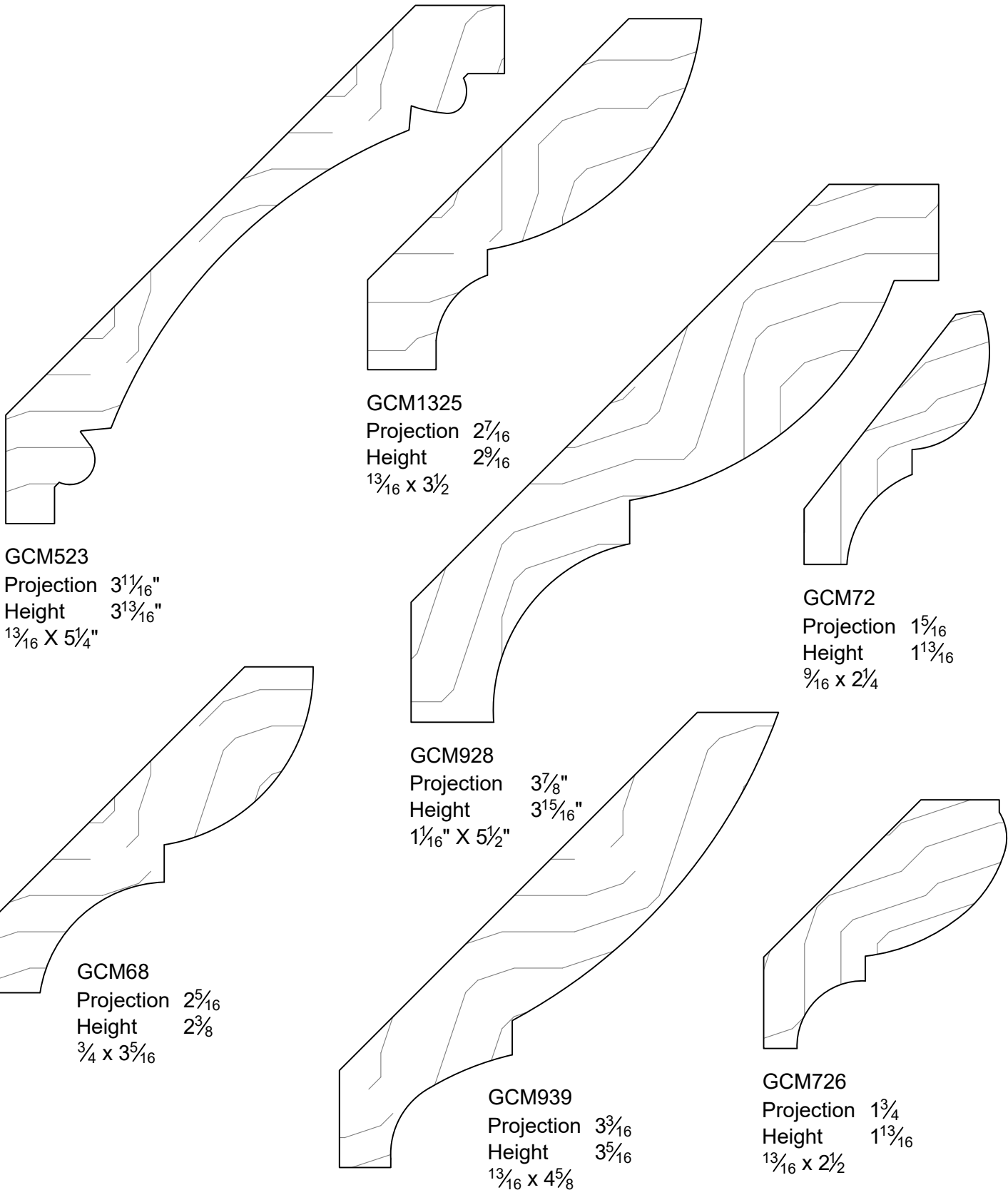

# GRAYCO BUILDING CENTER

WWW.GRAYCOINC.COM

BLUFFTON  
345 BUCK ISLAND RD, BLUFFTON SC 29910  
(843) 815-5788 FAX 815-5799

LADY'S ISLAND  
20 SAMS POINT WAY, BEAUFORT SC 29907  
(843) 522-9994 FAX 522-9972

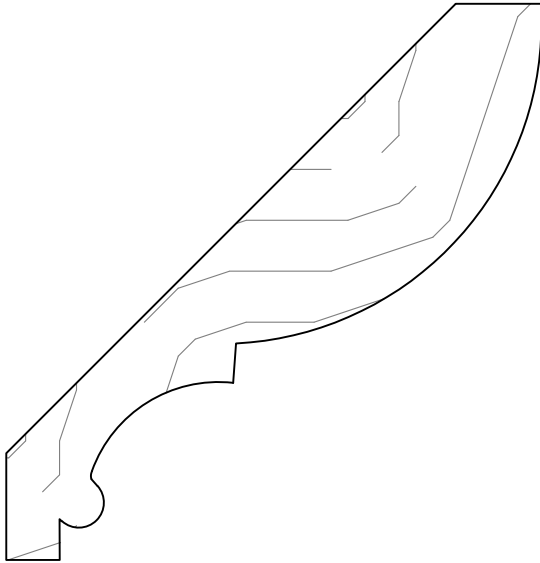

GCM502

Projection  $2\frac{3}{4}$   
Height  $2\frac{7}{8}$   
 $\frac{7}{8} \times 4$

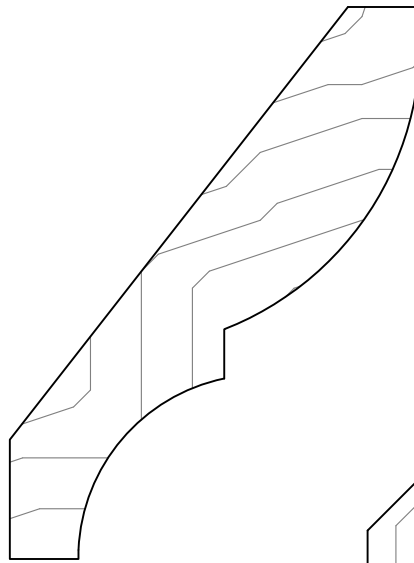

GCM506

Projection  $2\frac{1}{8}$   
Height  $2\frac{7}{8}$   
 $\frac{3}{4} \times 3\frac{1}{2}$

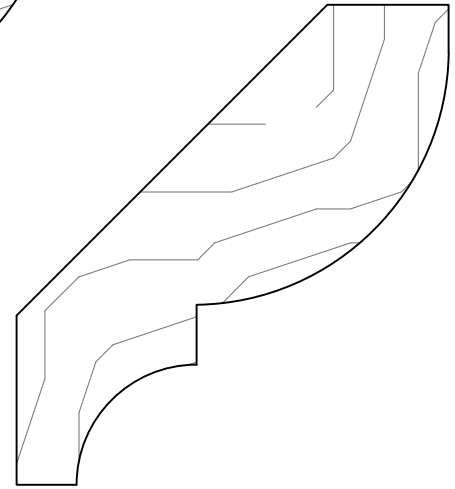

GCM538

PROJECTION  $2\frac{1}{4}$ "  
HEIGHT  $2\frac{1}{2}$ "  
 $1 \times 3\frac{3}{8}$

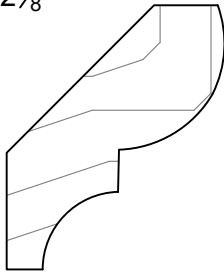

GCM74

Projection  $1\frac{1}{8}$   
Height  $1\frac{3}{8}$   
 $\frac{9}{16} \times 1\frac{3}{4}$

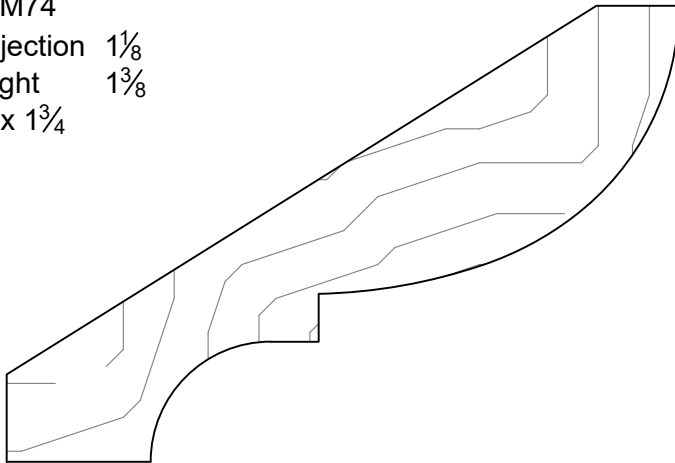

GCM536

PROJECTION  $3\frac{1}{2}$ "  
HEIGHT  $2\frac{3}{8}$ "  
 $\frac{7}{8} \times 4\frac{1}{4}$

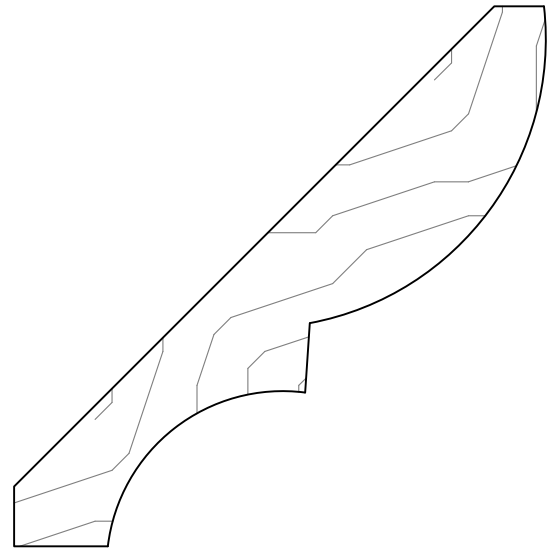

GCM593

$\frac{3}{4} \times 3\frac{15}{16}$   
PROJECTION  $2\frac{3}{4}$   
HEIGHT  $2\frac{13}{16}$

# GRAYCO BUILDING CENTER

WWW.GRAYCOINC.COM

BLUFFTON  
345 BUCK ISLAND RD, BLUFFTON SC 29910  
(843) 815-5788 FAX 815-5799

LADY'S ISLAND  
20 SAMS POINT WAY, BEAUFORT SC 29907  
(843) 522-9994 FAX 522-9972

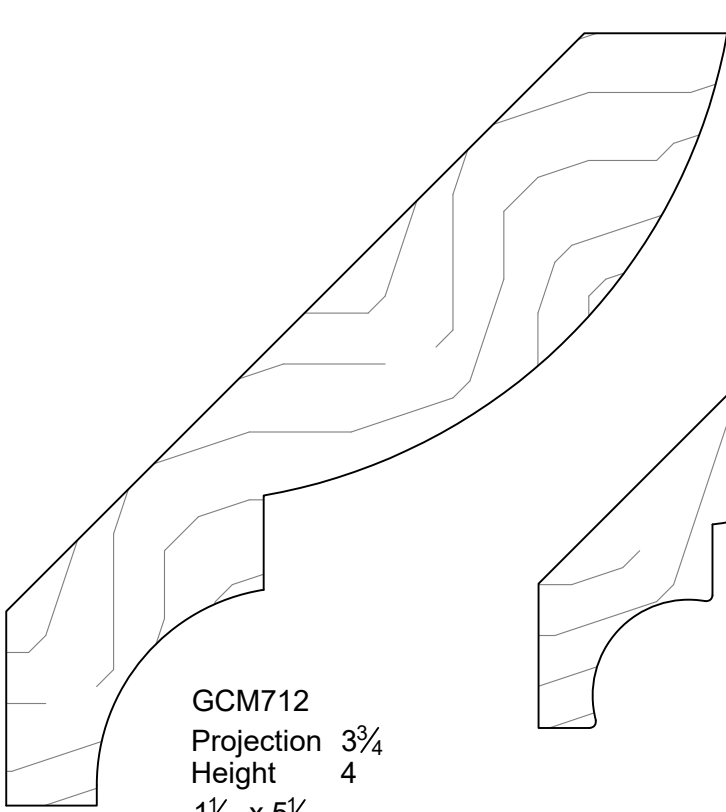

GCM712  
 Projection  $3\frac{3}{4}$   
 Height 4  
 $1\frac{1}{16} \times 5\frac{1}{2}$

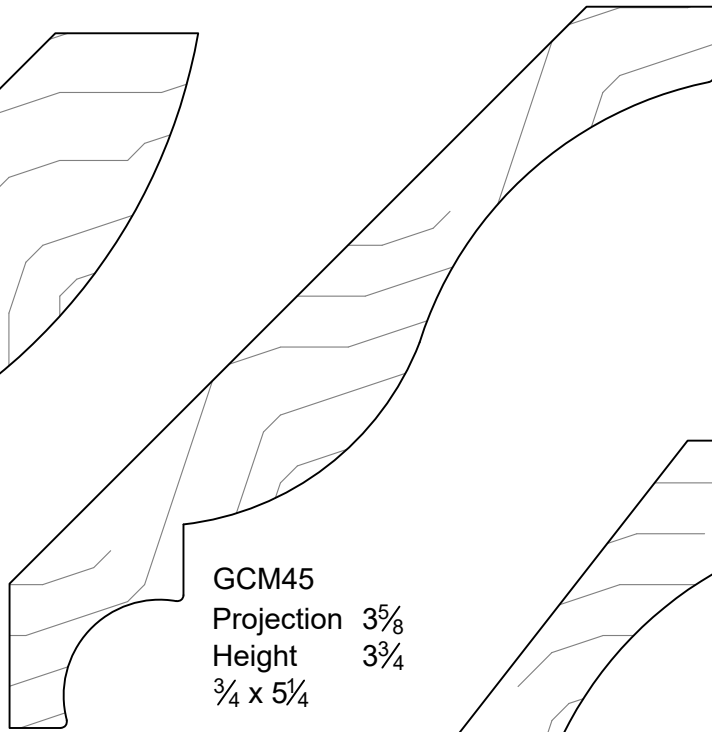

GCM45  
 Projection  $3\frac{5}{8}$   
 Height  $3\frac{3}{4}$   
 $\frac{3}{4} \times 5\frac{1}{4}$

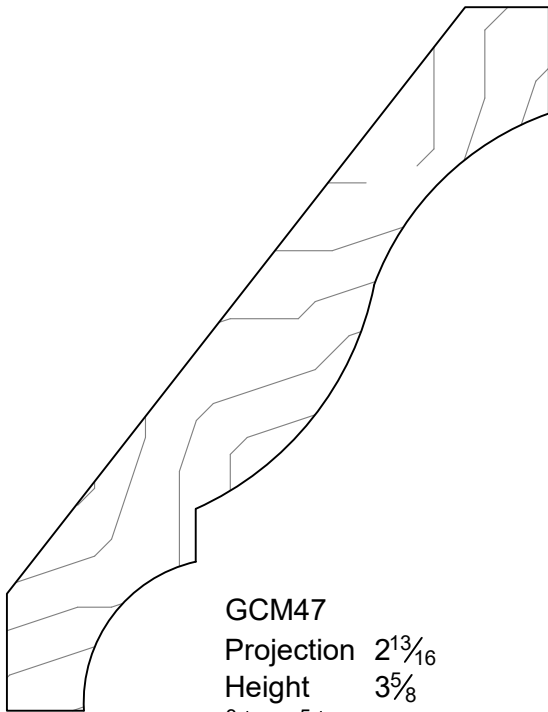

GCM47  
 Projection  $2\frac{13}{16}$   
 Height  $3\frac{5}{8}$   
 $\frac{3}{4} \times 4\frac{5}{8}$

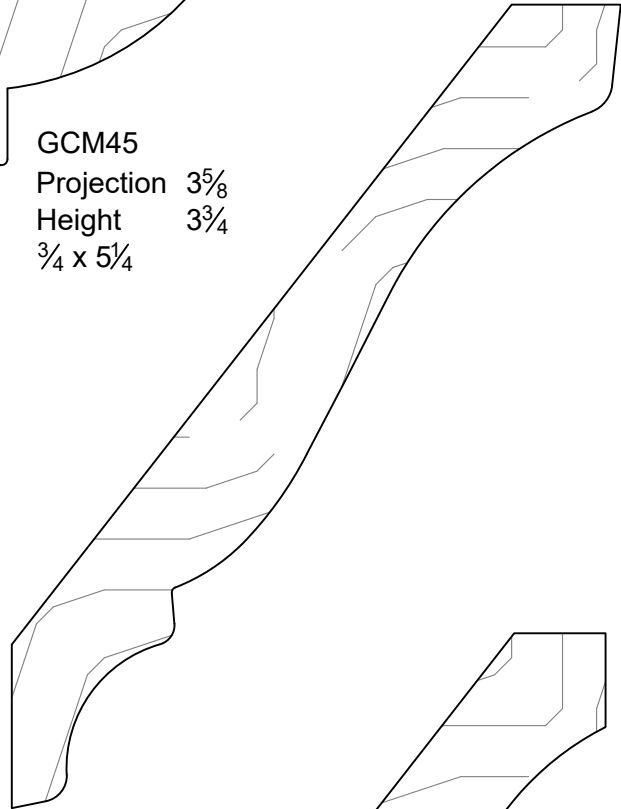

GCM595  
 $1\frac{1}{16} \times 5\frac{1}{4}$   
 PROJECTION  $3\frac{3}{16}$   
 HEIGHT  $4\frac{3}{16}$

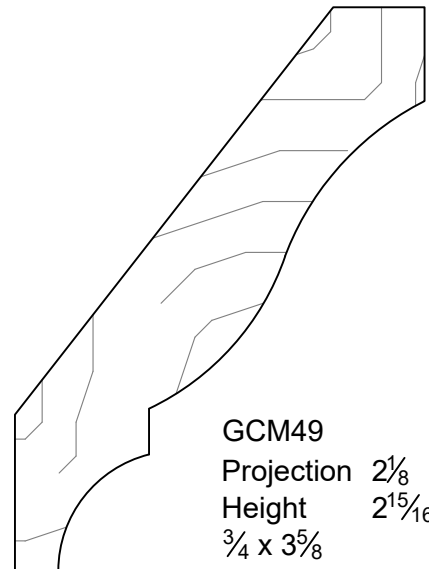

GCM49  
 Projection  $2\frac{1}{8}$   
 Height  $2\frac{15}{16}$   
 $\frac{3}{4} \times 3\frac{5}{8}$

# GRAYCO BUILDING CENTER

WWW.GRAYCOINC.COM

BLUFFTON  
 345 BUCK ISLAND RD, BLUFFTON SC 29910  
 (843) 815-5788 FAX 815-5799

LADY'S ISLAND  
 20 SAMS POINT WAY, BEAUFORT SC 29907  
 (843) 522-9994 FAX 522-9972



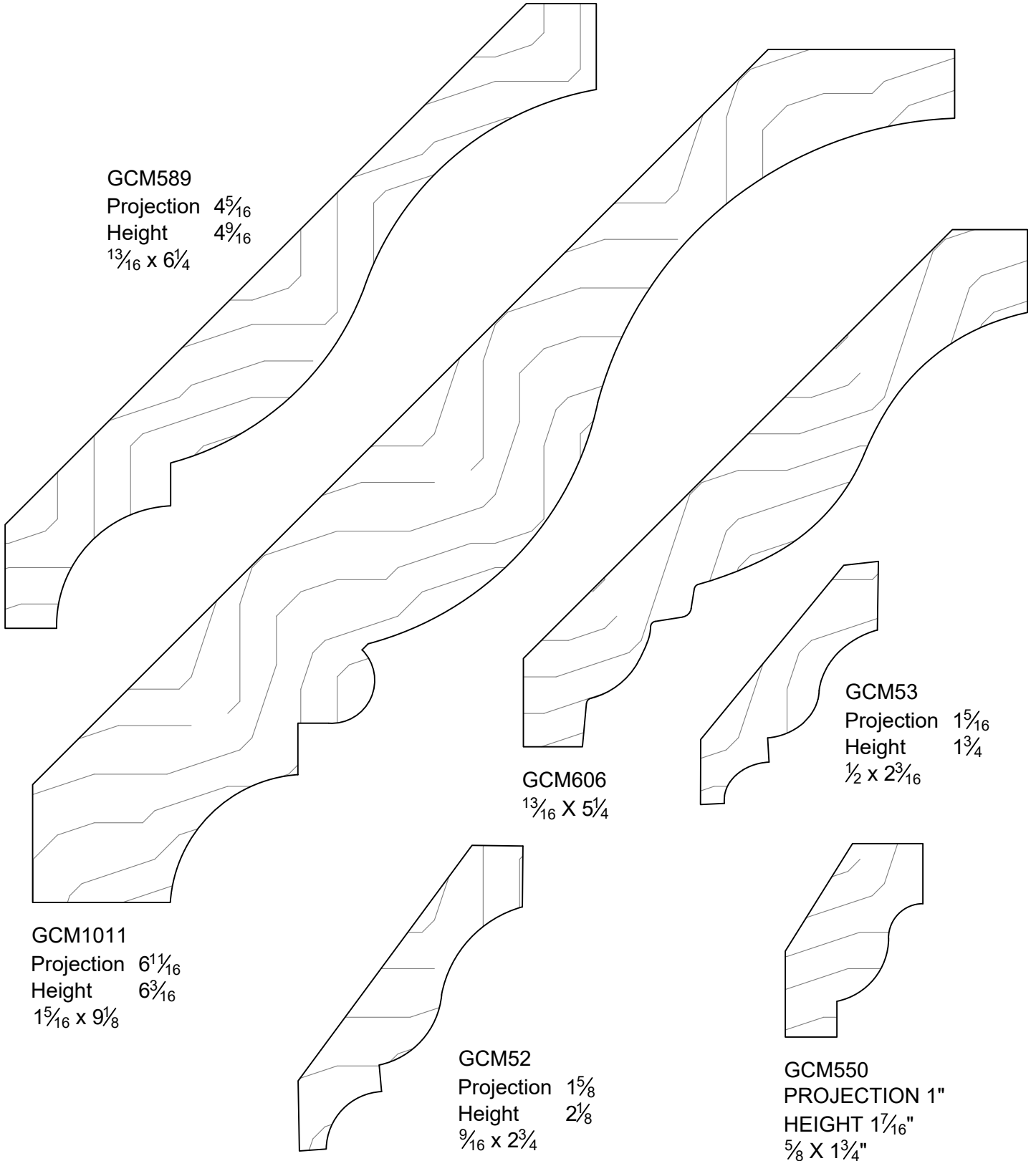

GCM589  
 Projection  $4\frac{5}{16}$   
 Height  $4\frac{9}{16}$   
 $1\frac{3}{16} \times 6\frac{1}{4}$

GCM606  
 $1\frac{3}{16} \times 5\frac{1}{4}$

GCM53  
 Projection  $1\frac{5}{16}$   
 Height  $1\frac{3}{4}$   
 $\frac{1}{2} \times 2\frac{3}{16}$

GCM1011  
 Projection  $6\frac{1}{16}$   
 Height  $6\frac{3}{16}$   
 $1\frac{5}{16} \times 9\frac{1}{8}$

GCM52  
 Projection  $1\frac{5}{8}$   
 Height  $2\frac{1}{8}$   
 $\frac{9}{16} \times 2\frac{3}{4}$

GCM550  
 PROJECTION 1"  
 HEIGHT  $1\frac{7}{16}$ "  
 $\frac{5}{8} \times 1\frac{3}{4}$ "

# GRAYCO BUILDING CENTER

WWW.GRAYCOINC.COM

BLUFFTON  
 345 BUCK ISLAND RD, BLUFFTON SC 29910  
 (843) 815-5788 FAX 815-5799

LADY'S ISLAND  
 20 SAMS POINT WAY, BEAUFORT SC 29907  
 (843) 522-9994 FAX 522-9972

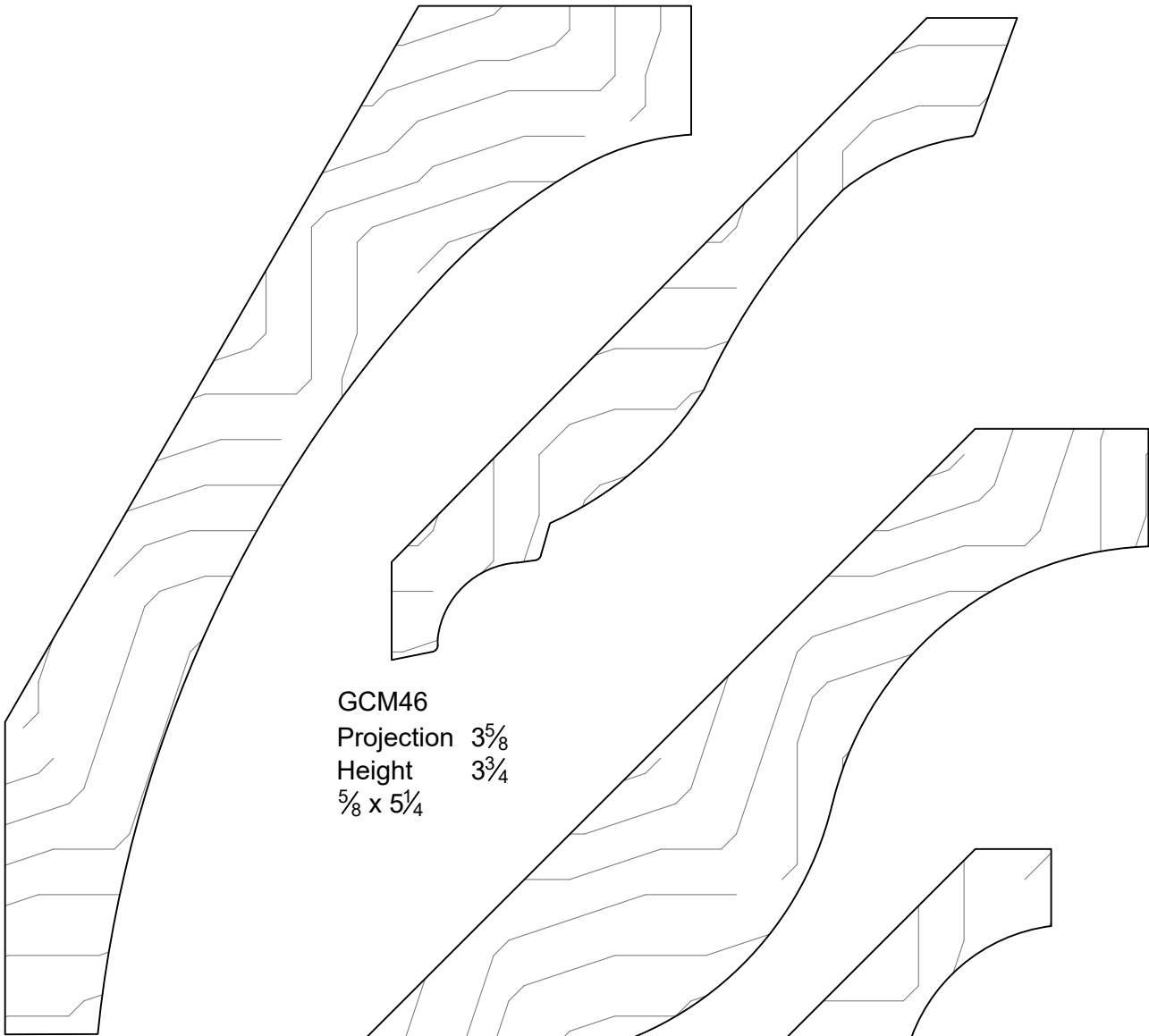

GCM46  
 Projection  $3\frac{5}{8}$   
 Height  $3\frac{3}{4}$   
 $\frac{5}{8} \times 5\frac{1}{4}$

GCM1106  
 Projection 4  
 Height 6  
 $1\frac{3}{4} \times 7\frac{3}{16}$

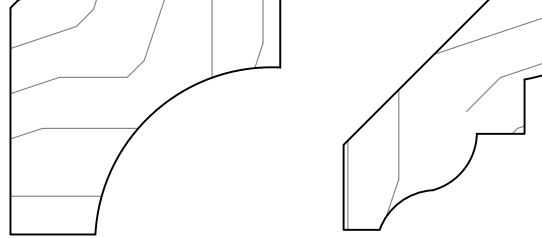

GCM1249  
 Projection  $4\frac{7}{8}$ "  
 Height  $5\frac{1}{16}$ "  
 $1\frac{1}{4} \times 7$ "

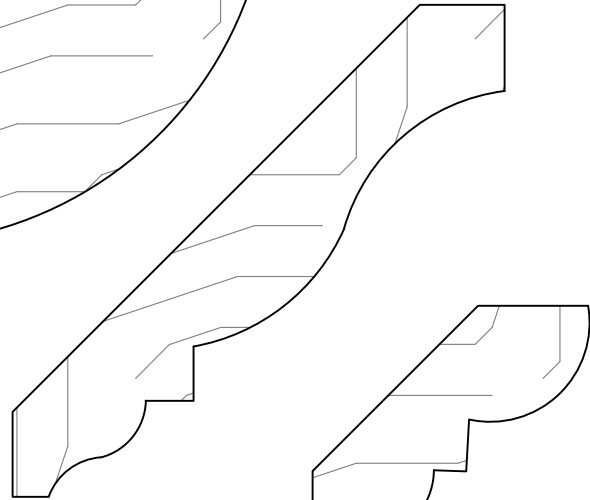

GCM69  
 Projection  $2\frac{9}{16}$   
 Height  $2\frac{9}{16}$   
 $\frac{5}{8} \times 3\frac{5}{8}$

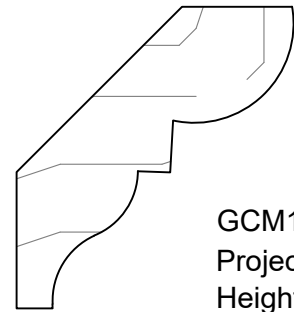

GCM1415  
 Projection  $1\frac{7}{16}$   
 Height  $1\frac{9}{16}$   
 $\frac{5}{8} \times 2\frac{1}{8}$

# GRAYCO BUILDING CENTER

WWW.GRAYCOINC.COM

BLUFFTON  
 345 BUCK ISLAND RD, BLUFFTON SC 29910  
 (843) 815-5788 FAX 815-5799

LADY'S ISLAND  
 20 SAMS POINT WAY, BEAUFORT SC 29907  
 (843) 522-9994 FAX 522-9972

GCM542  
PROJECTION  $3\frac{3}{16}$ "  
HEIGHT  $3\frac{3}{16}$ "  
 $\frac{3}{4} \times 4\frac{1}{8}$

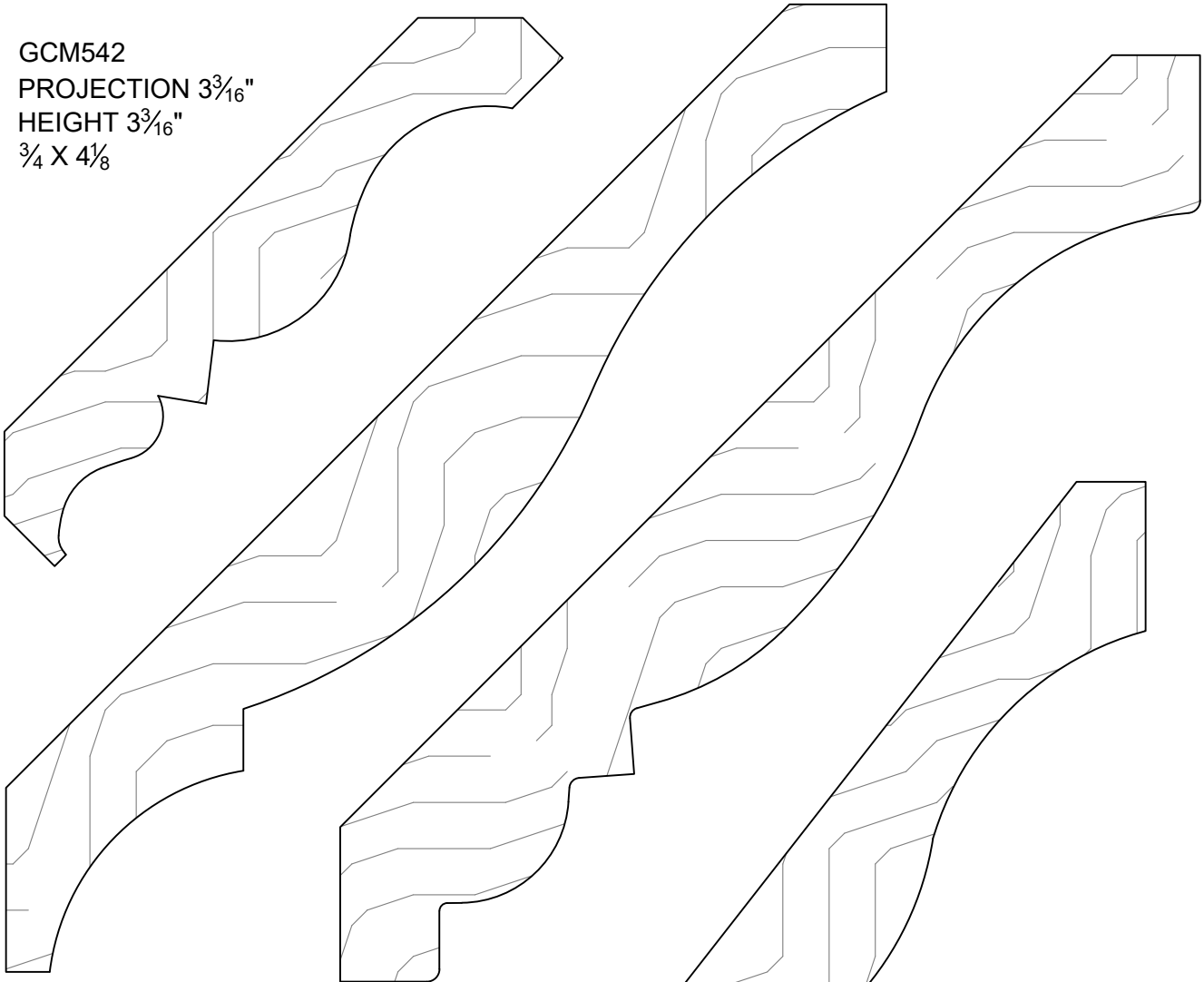

GCM646  
Projection 5  
Height  $5\frac{9}{16}$   
 $1 \times 7\frac{1}{2}$

GCM608  
Projection  $4\frac{15}{16}$   
Height  $5\frac{5}{16}$   
 $1 \times 7\frac{1}{4}$

GCM40625  
Projection  $3\frac{1}{16}$   
Height  $4\frac{7}{8}$   
 $\frac{7}{8} \times 6\frac{1}{8}$

GCM44275  
Projection 2  
Height  $2\frac{1}{8}$   
 $\frac{13}{16} \times 2\frac{3}{4}$

# GRAYCO BUILDING CENTER

WWW.GRAYCOINC.COM

BLUFFTON  
345 BUCK ISLAND RD, BLUFFTON SC 29910  
(843) 815-5788 FAX 815-5799

LADY'S ISLAND  
20 SAMS POINT WAY, BEAUFORT SC 29907  
(843) 522-9994 FAX 522-9972

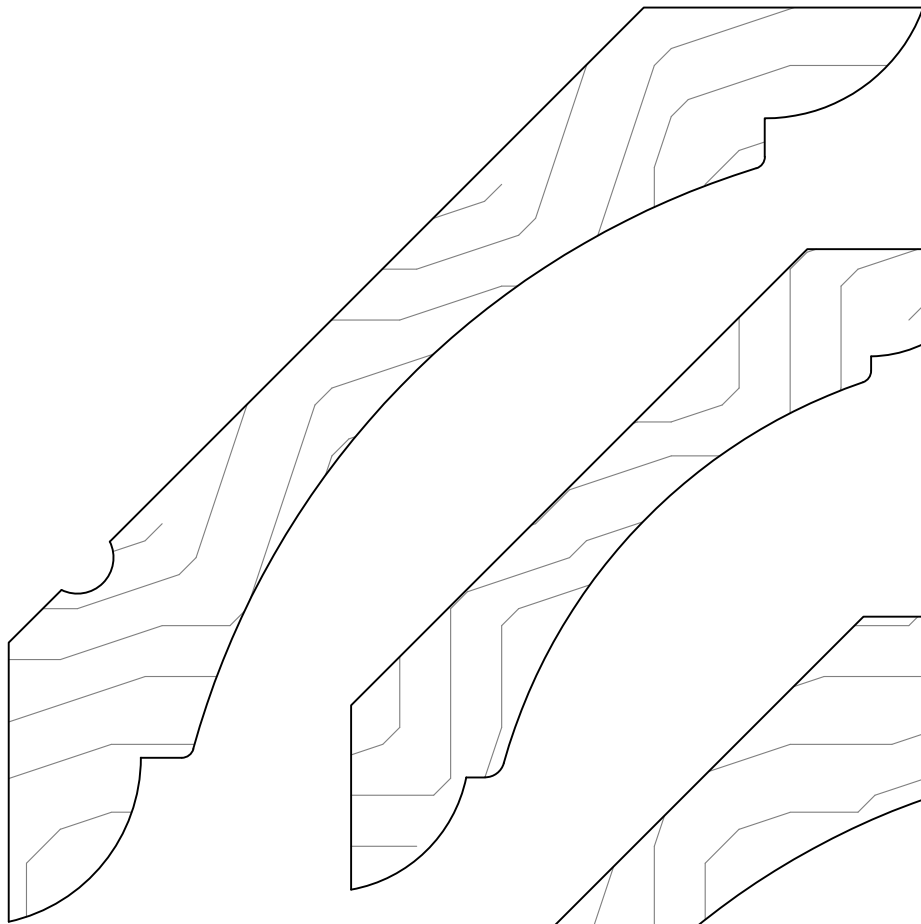

GCM56625  
Projection  $4\frac{3}{4}$   
Height  $4\frac{3}{4}$   
 $1\frac{1}{8} \times 6\frac{3}{4}$

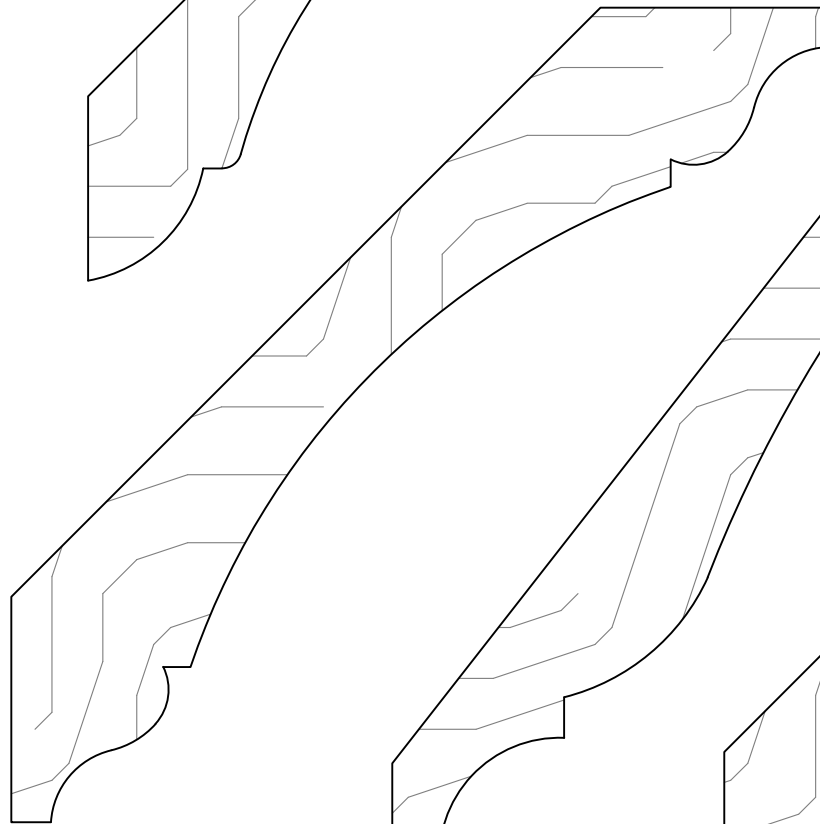

GCM599  
Projection  $4\frac{1}{4}$   
Height  $4\frac{1}{4}$   
1 X 6

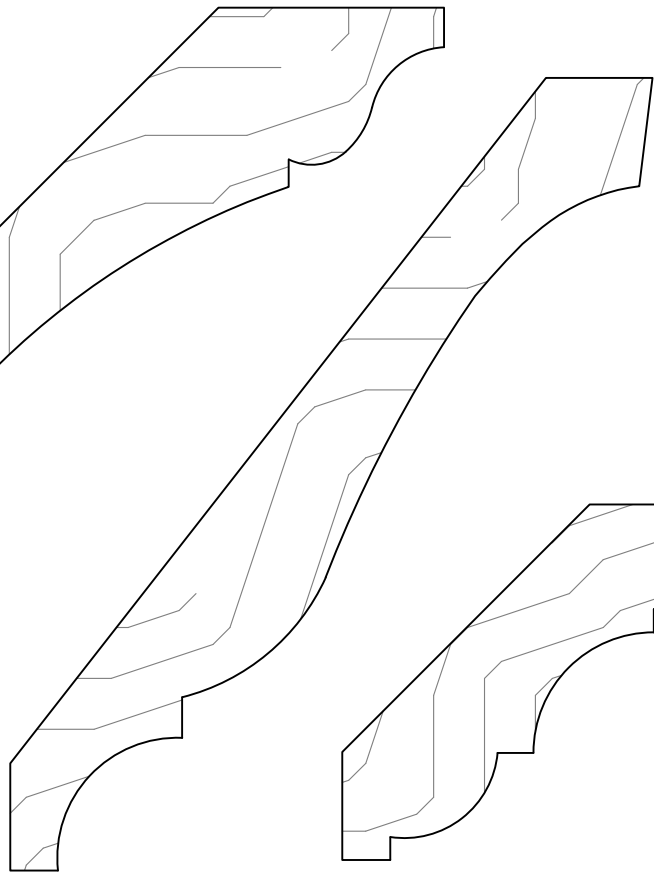

GCM5312  
Projection  $3\frac{5}{16}$   
Height  $4\frac{1}{8}$   
 $\frac{3}{4} \times 5\frac{5}{16}$

GCM590  
Projection  $3\frac{5}{16}$   
Height  $3\frac{5}{16}$   
 $1\frac{3}{16} \times 4\frac{1}{16}$

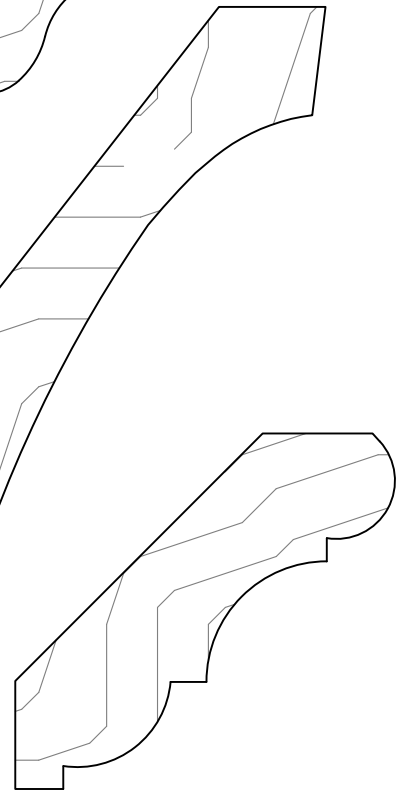

GCM1045  
Projection  $1\frac{13}{16}$   
Height 2  
 $\frac{3}{4} \times 2\frac{5}{8}$

# GRAYCO BUILDING CENTER

[WWW.GRAYCOINC.COM](http://WWW.GRAYCOINC.COM)

BLUFFTON  
345 BUCK ISLAND RD, BLUFFTON SC 29910  
(843) 815-5788 FAX 815-5799

LADY'S ISLAND  
20 SAMS POINT WAY, BEAUFORT SC 29907  
(843) 522-9994 FAX 522-9972

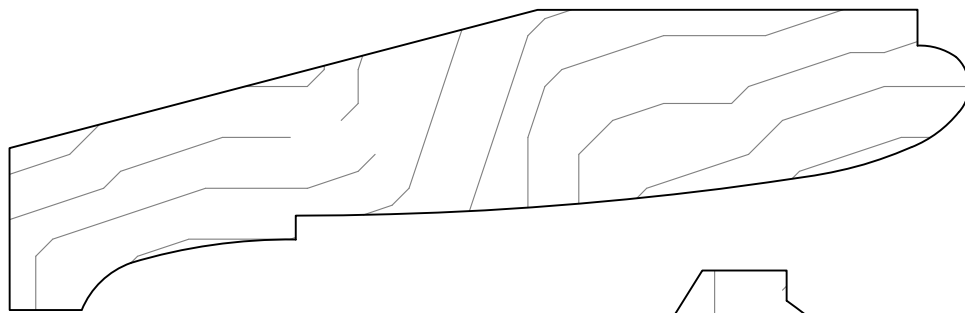

GCM1158  
 Projection 5  
 Height  $1\frac{1}{16}$   
 $1\frac{1}{4}$  x  $5\frac{1}{8}$

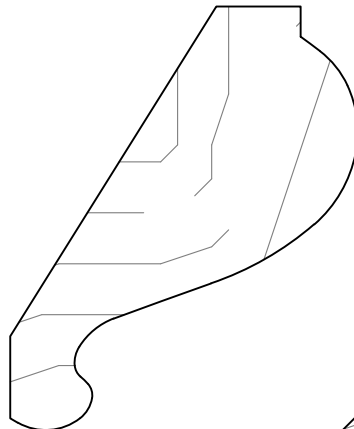

GCM594  
 $1\frac{1}{16}$  X  $2\frac{5}{8}$   
 PROJECTION  $1\frac{13}{16}$   
 HEIGHT  $2\frac{3}{16}$

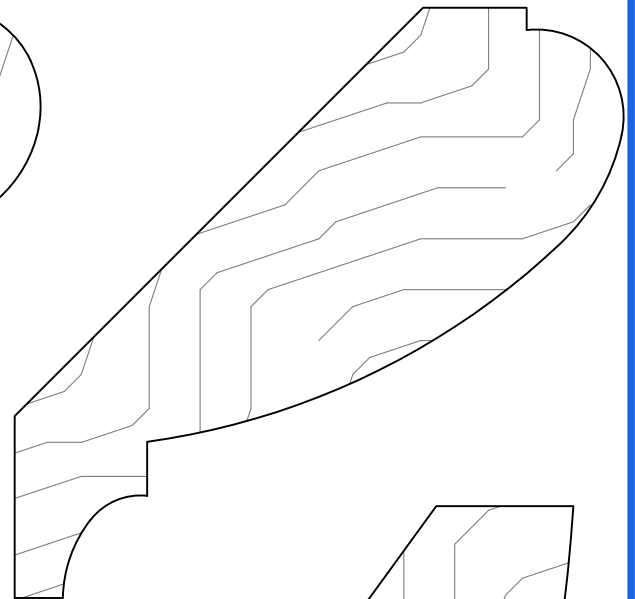

GCM545  
 PROJECTION  $3\frac{3}{16}$ "  
 HEIGHT  $3\frac{1}{16}$ "  
 $1\frac{3}{8}$  X  $4\frac{1}{8}$

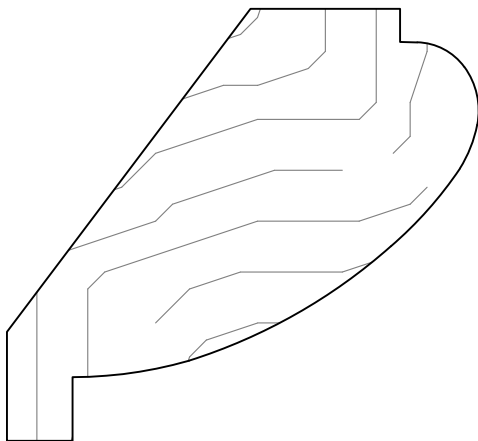

GCM561  
 PROJECTION  $2\frac{3}{8}$ "  
 HEIGHT  $2\frac{1}{4}$ "  
 $1\frac{3}{8}$ " x 3"

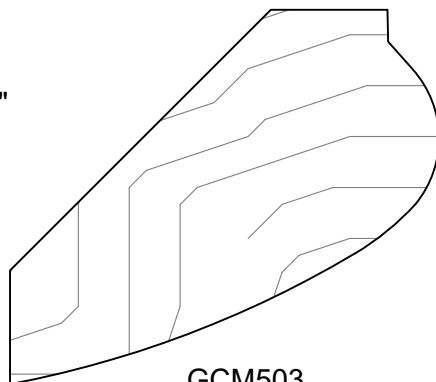

GCM503  
 Projection 2  
 Height 2  
 $1\frac{1}{4}$  x  $2\frac{3}{4}$

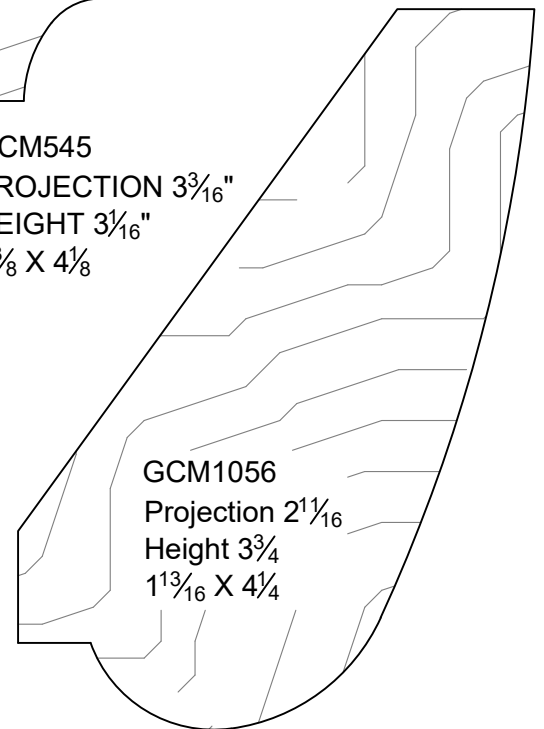

GCM1056  
 Projection  $2\frac{1}{16}$   
 Height  $3\frac{3}{4}$   
 $1\frac{13}{16}$  X  $4\frac{1}{4}$

# GRAYCO BUILDING CENTER

WWW.GRAYCOINC.COM

BLUFFTON  
 345 BUCK ISLAND RD, BLUFFTON SC 29910  
 (843) 815-5788 FAX 815-5799

LADY'S ISLAND  
 20 SAMS POINT WAY, BEAUFORT SC 29907  
 (843) 522-9994 FAX 522-9972

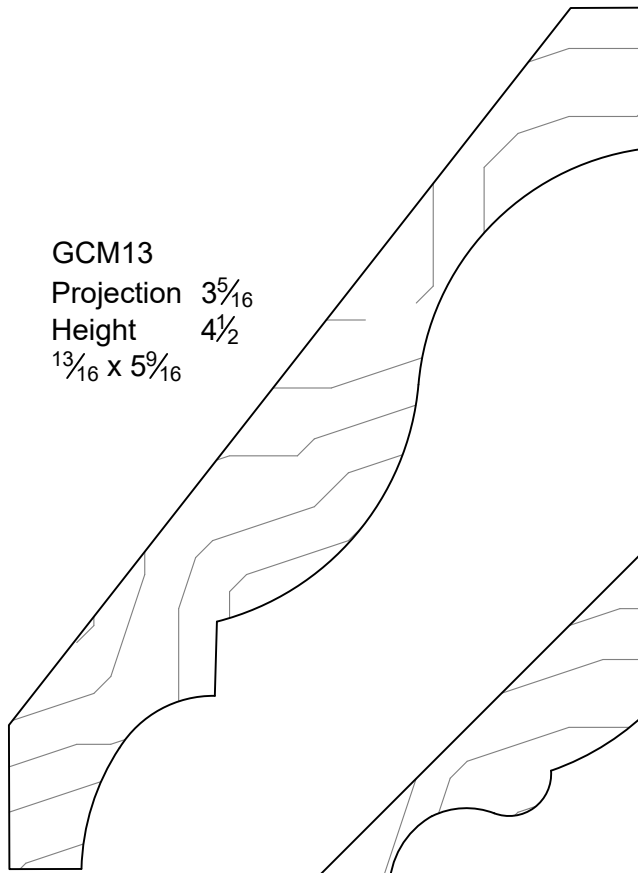

GCM13  
Projection  $3\frac{5}{16}$   
Height  $4\frac{1}{2}$   
 $1\frac{3}{16} \times 5\frac{9}{16}$

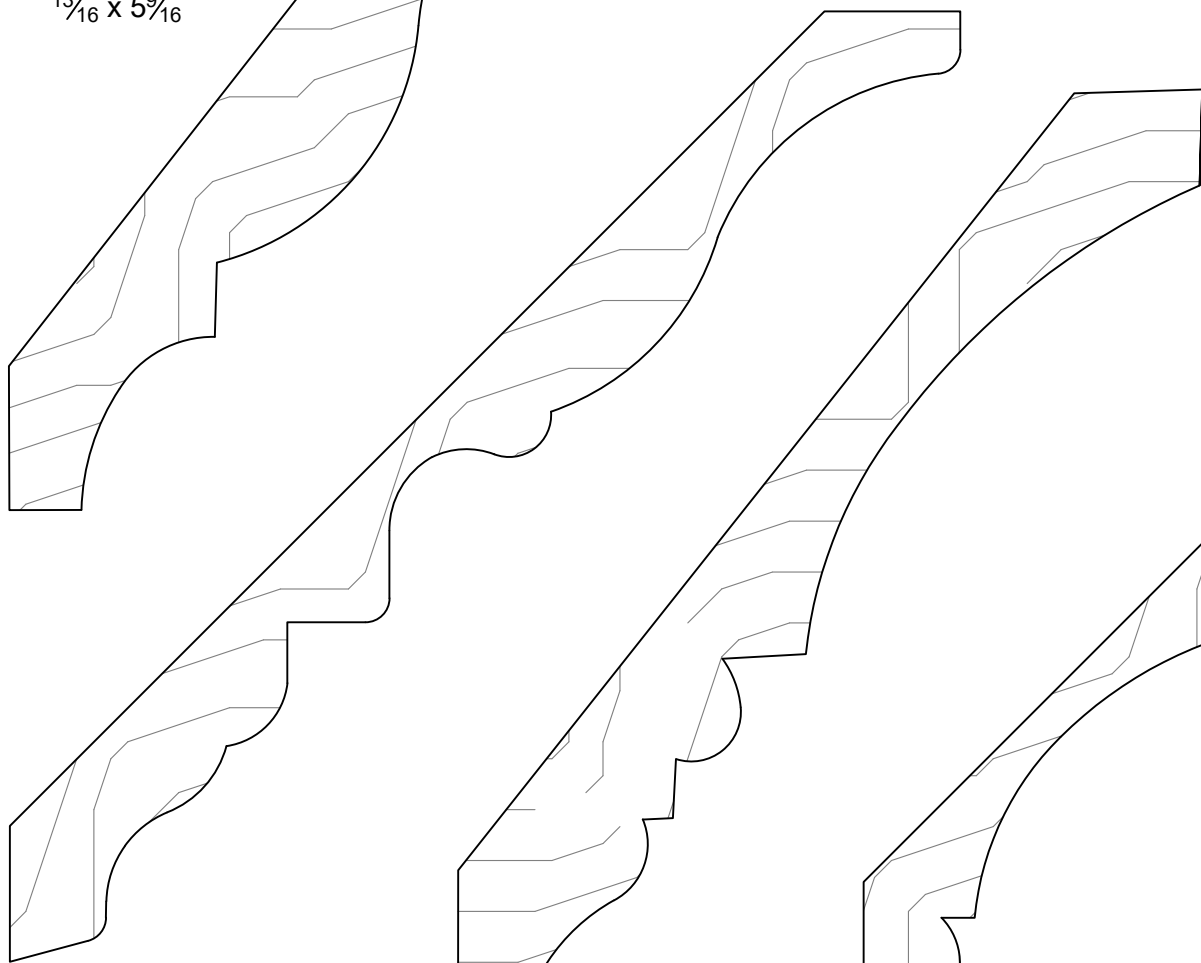

GCM601  
Projection 5  
Height 5  
 $\frac{3}{4} \times 7$

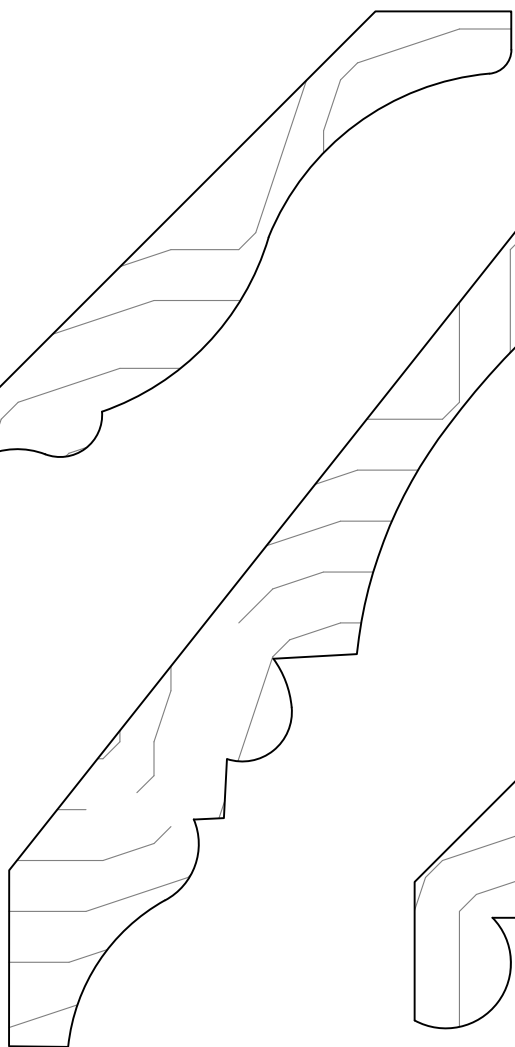

GCM56  
Projection  $3\frac{7}{8}$   
Height 5  
 $1\frac{3}{16} \times 6\frac{5}{16}$

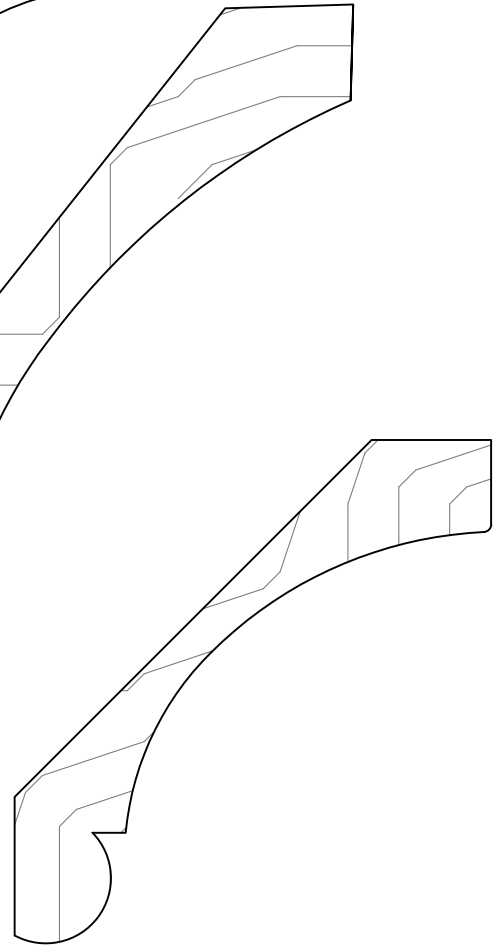

GCM546  
PROJECTION  $2\frac{1}{2}$ "  
HEIGHT  $2\frac{5}{8}$ "  
 $\frac{3}{4} \times 3\frac{9}{16}$ "

# GRAYCO BUILDING CENTER

WWW.GRAYCOINC.COM

BLUFFTON  
345 BUCK ISLAND RD, BLUFFTON SC 29910  
(843) 815-5788 FAX 815-5799

LADY'S ISLAND  
20 SAMS POINT WAY, BEAUFORT SC 29907  
(843) 522-9994 FAX 522-9972



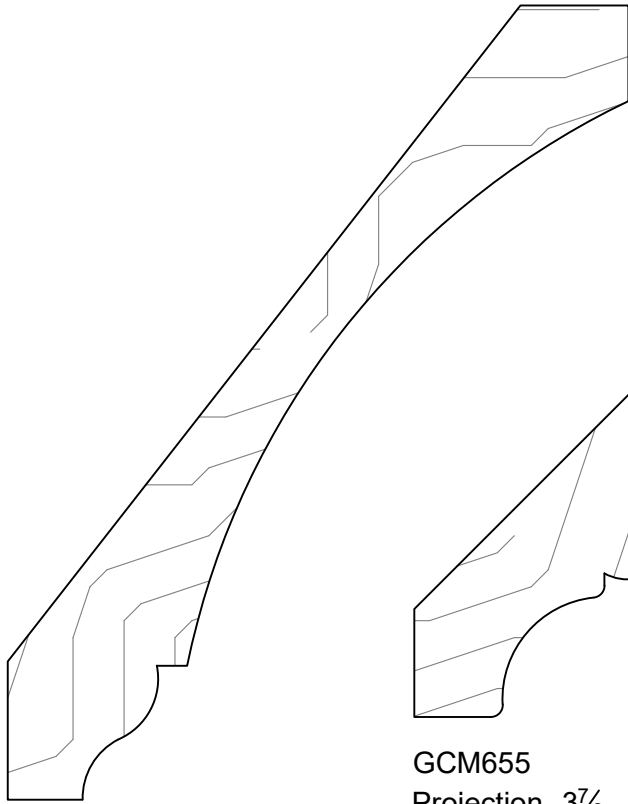

GCM514  
 Projection  $3\frac{1}{4}$   
 Height  $4\frac{1}{8}$   
 $3\frac{1}{4} \times 5\frac{1}{4}$

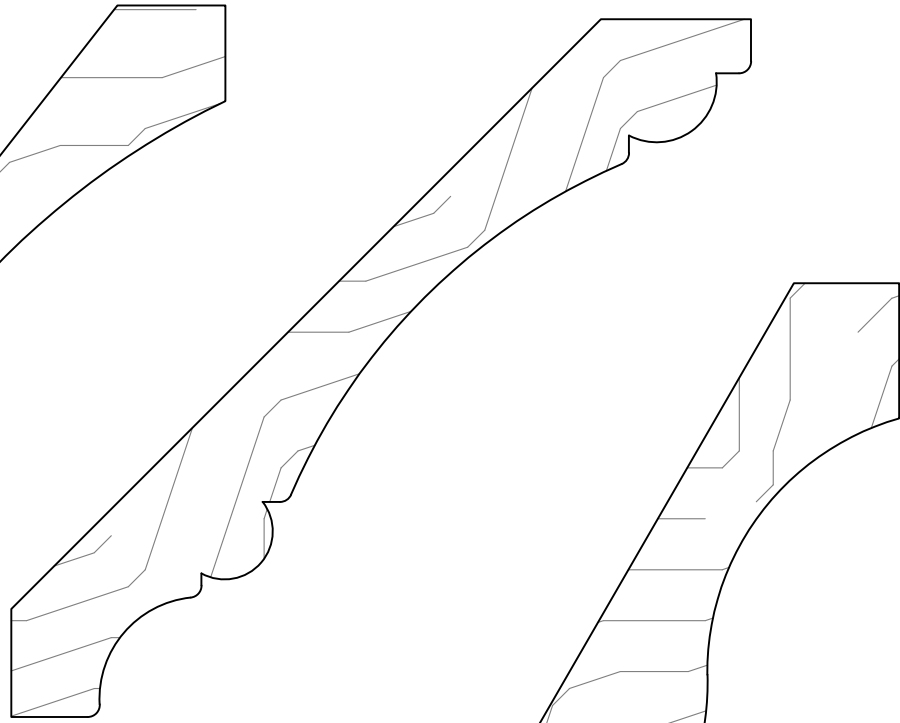

GCM655  
 Projection  $3\frac{7}{8}$   
 Height  $3\frac{5}{8}$   
 $3\frac{1}{4} \times 5\frac{1}{4}$

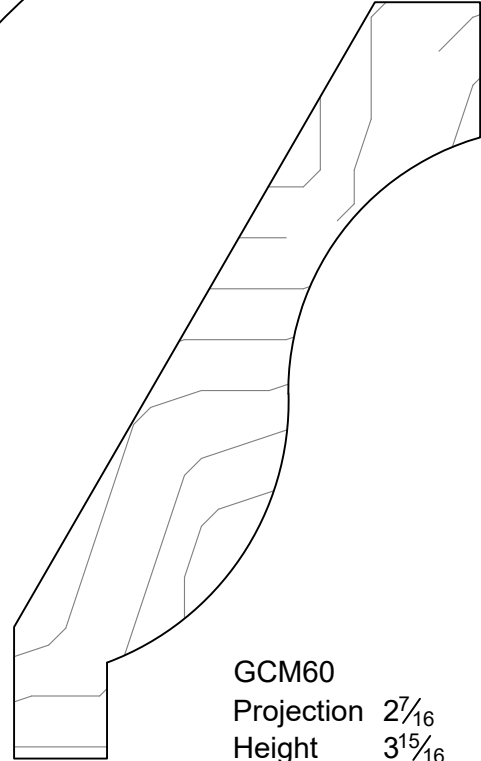

GCM60  
 Projection  $2\frac{7}{16}$   
 Height  $3\frac{15}{16}$   
 $1\frac{3}{16} \times 4\frac{5}{8}$

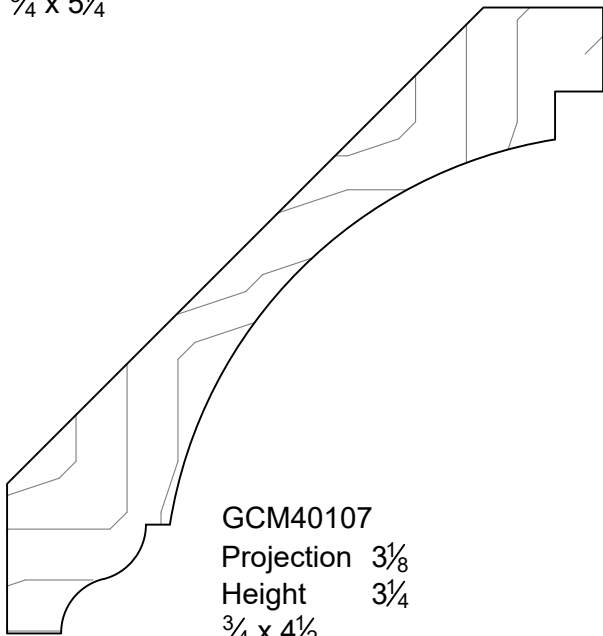

GCM40107  
 Projection  $3\frac{1}{8}$   
 Height  $3\frac{3}{4}$   
 $3\frac{1}{4} \times 4\frac{1}{2}$



GCM596  
 Projection  $1\frac{1}{4}$   
 Height 2  
 $3\frac{1}{4} \times 2\frac{1}{4}$

# GRAYCO BUILDING CENTER

WWW.GRAYCOINC.COM

BLUFFTON  
 345 BUCK ISLAND RD, BLUFFTON SC 29910  
 (843) 815-5788 FAX 815-5799

LADY'S ISLAND  
 20 SAMS POINT WAY, BEAUFORT SC 29907  
 (843) 522-9994 FAX 522-9972

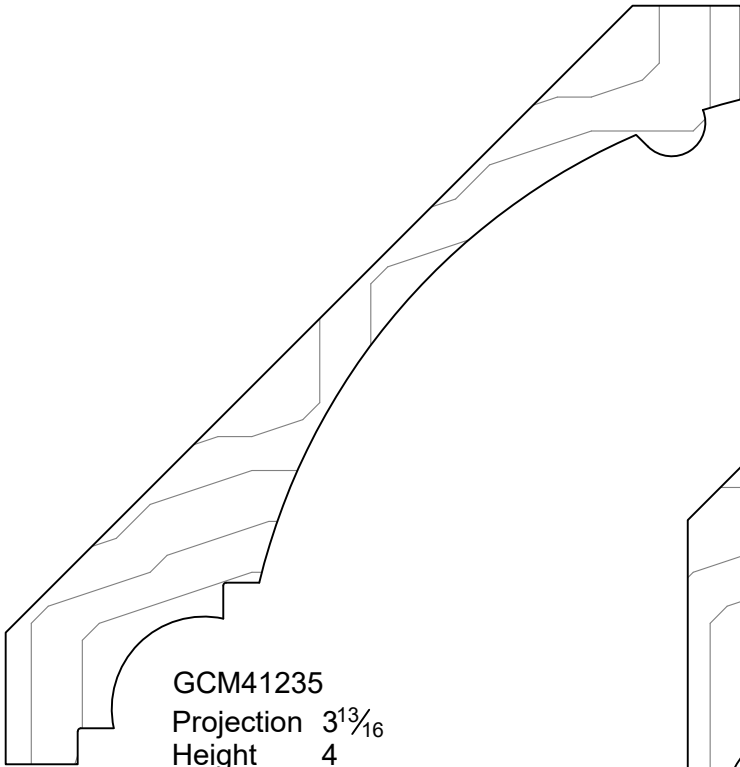

GCM41235  
 Projection  $3\frac{13}{16}$   
 Height 4  
 $\frac{3}{4} \times 5\frac{1}{2}$

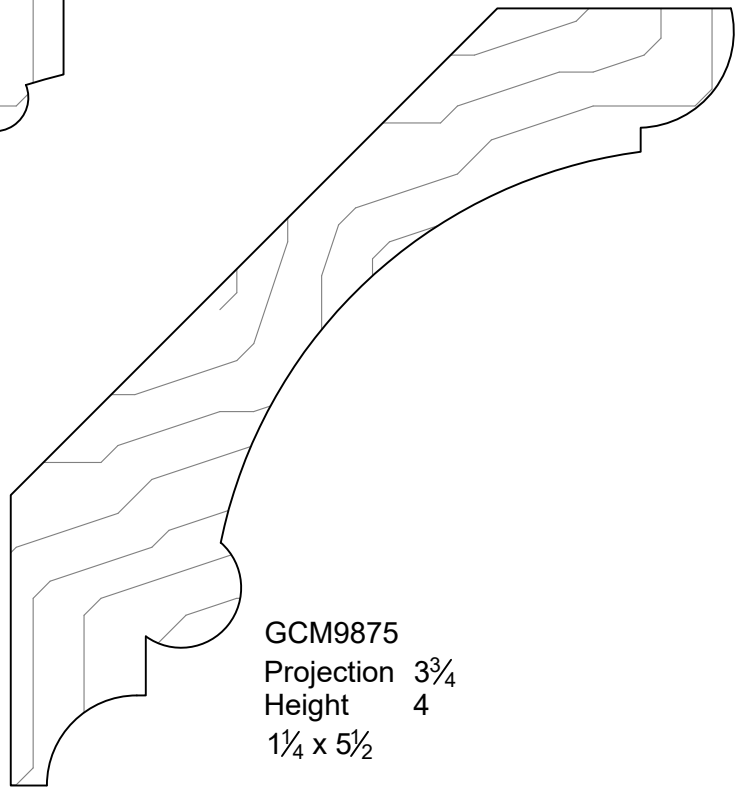

GCM9875  
 Projection  $3\frac{3}{4}$   
 Height 4  
 $1\frac{1}{4} \times 5\frac{1}{2}$

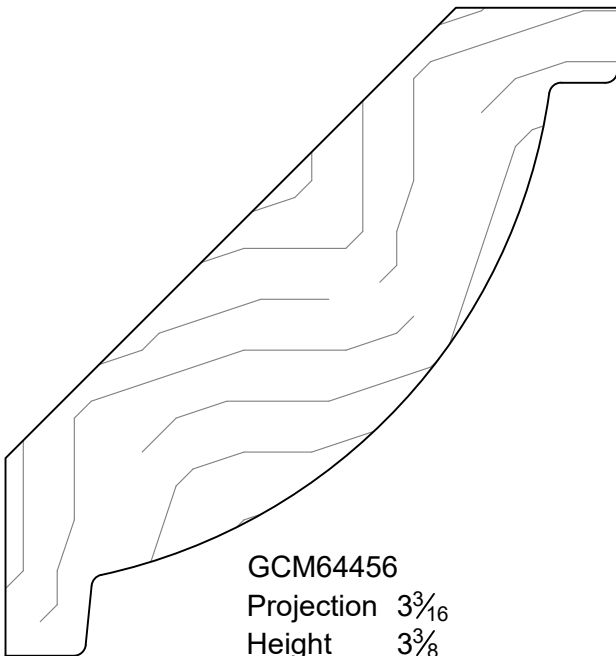

GCM64456  
 Projection  $3\frac{3}{16}$   
 Height  $3\frac{3}{8}$   
 $1\frac{1}{4} \times 4\frac{5}{8}$

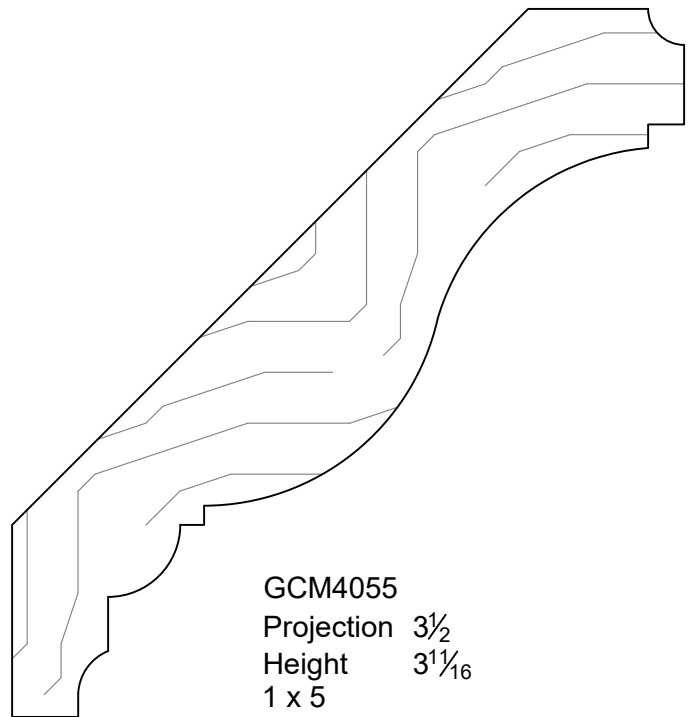

GCM4055  
 Projection  $3\frac{1}{2}$   
 Height  $3\frac{11}{16}$   
 1 x 5

# GRAYCO BUILDING CENTER

WWW.GRAYCOINC.COM

BLUFFTON  
 345 BUCK ISLAND RD, BLUFFTON SC 29910  
 (843) 815-5788 FAX 815-5799

LADY'S ISLAND  
 20 SAMS POINT WAY, BEAUFORT SC 29907  
 (843) 522-9994 FAX 522-9972

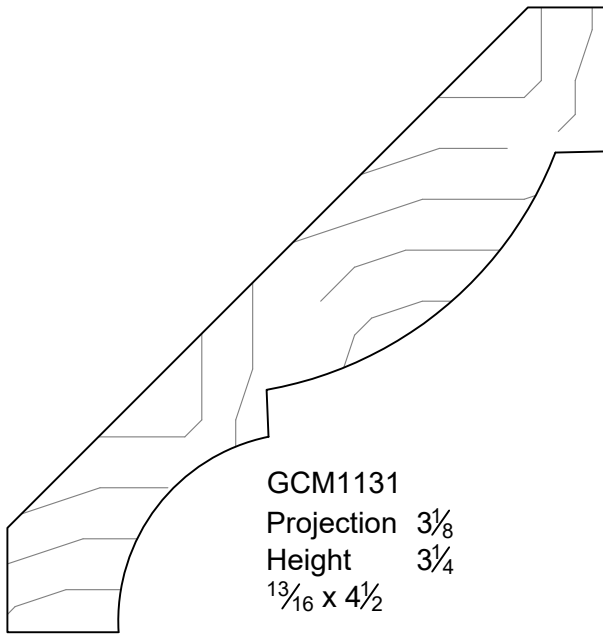

GCM1131  
Projection  $3\frac{3}{8}$   
Height  $3\frac{3}{4}$   
 $1\frac{3}{16} \times 4\frac{1}{2}$

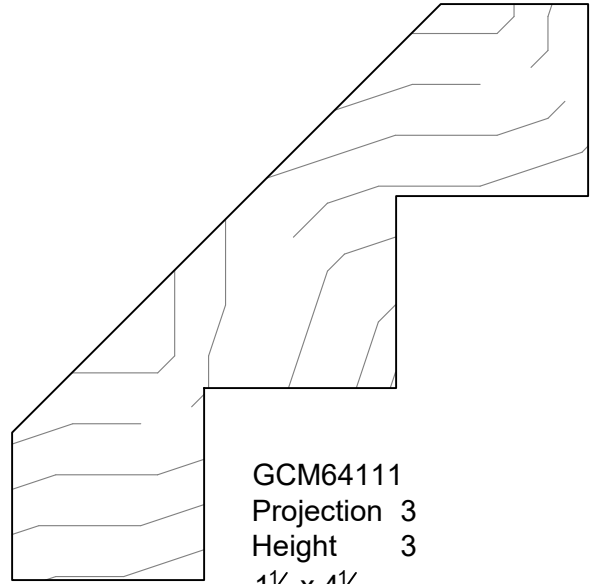

GCM64111  
Projection 3  
Height 3  
 $1\frac{1}{4} \times 4\frac{1}{4}$

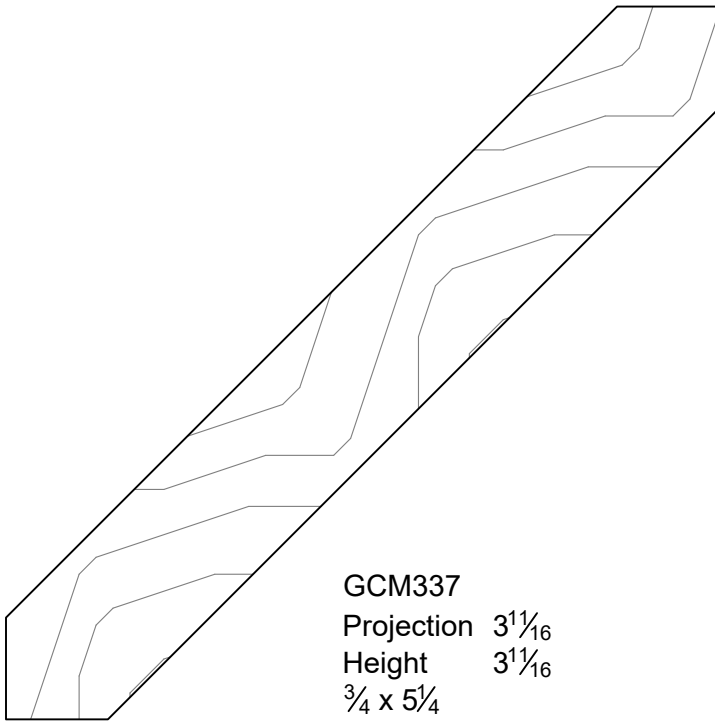

GCM337  
Projection  $3\frac{11}{16}$   
Height  $3\frac{11}{16}$   
 $\frac{3}{4} \times 5\frac{1}{4}$

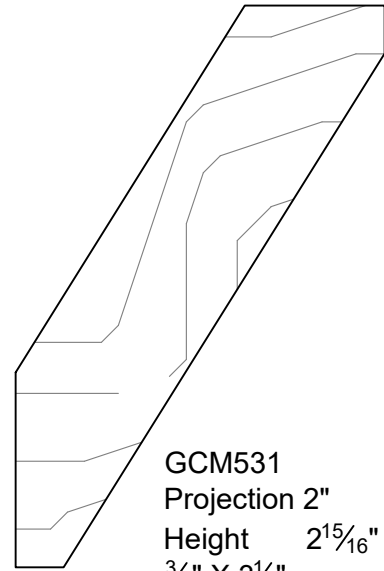

GCM531  
Projection 2"  
Height  $2\frac{15}{16}$ "  
 $\frac{3}{4}" \times 3\frac{1}{2}"$

# GRAYCO BUILDING CENTER

WWW.GRAYCOINC.COM

BLUFFTON  
345 BUCK ISLAND RD, BLUFFTON SC 29910  
(843) 815-5788 FAX 815-5799

LADY'S ISLAND  
20 SAMS POINT WAY, BEAUFORT SC 29907  
(843) 522-9994 FAX 522-9972

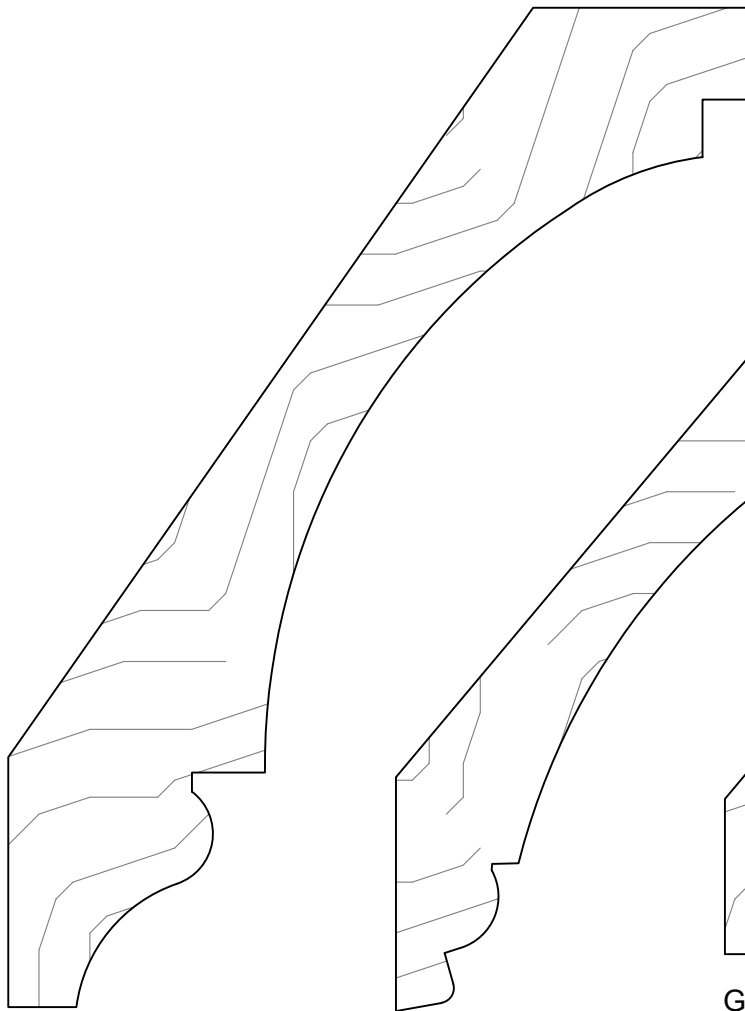

GCM612  
Projection  $3\frac{7}{8}$   
Height  $5\frac{1}{4}$   
 $1\frac{3}{16} \times 6\frac{7}{16}$

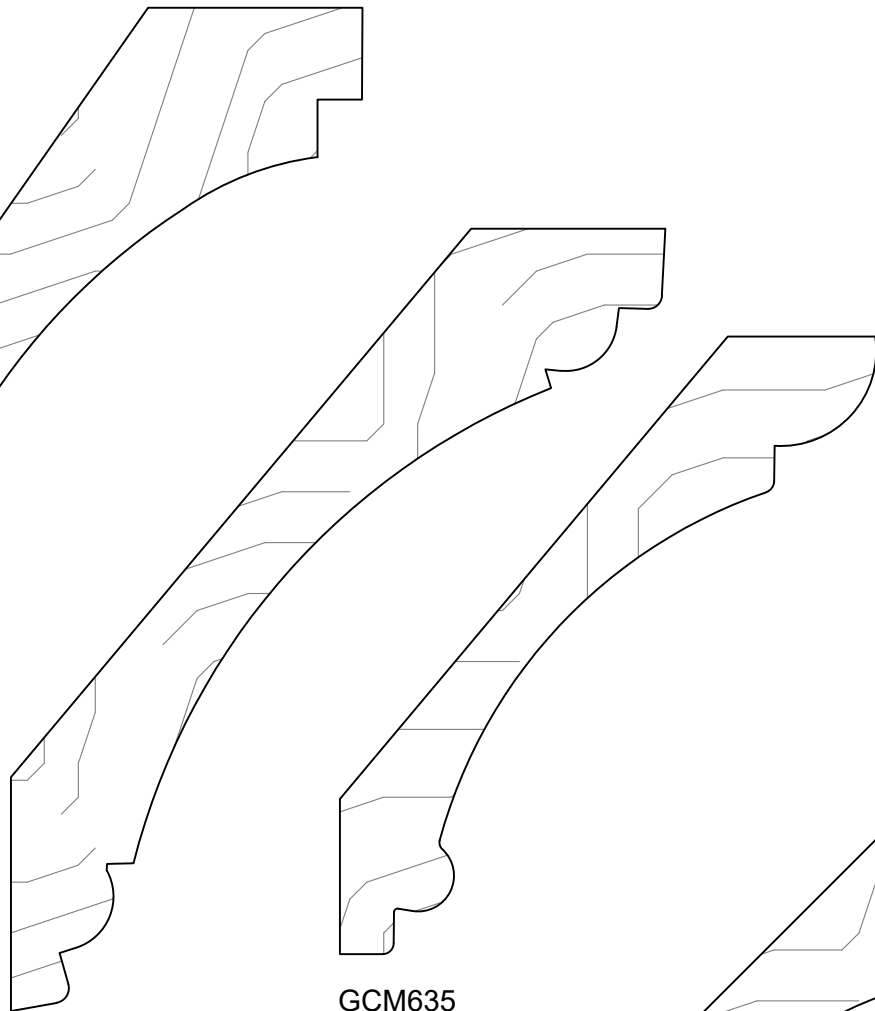

GCM627  
Projection  $3\frac{7}{16}$   
Height  $4\frac{1}{16}$   
 $1 \times 5\frac{5}{16}$

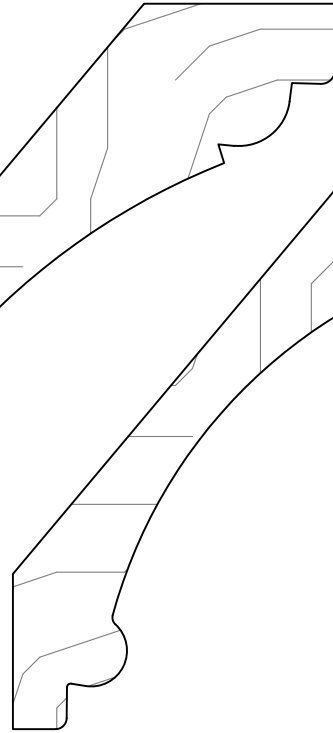

GCM635  
Projection  $2\frac{3}{4}$   
Height  $3\frac{1}{4}$   
 $\frac{3}{4} \times 4\frac{1}{4}$

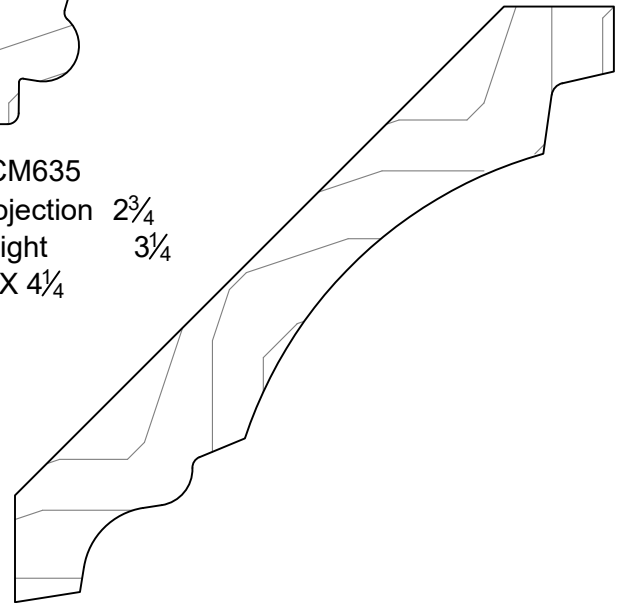

GCM630  
Projection  $3\frac{1}{8}$   
Height  $3\frac{3}{8}$   
 $1\frac{1}{16} \times 4\frac{7}{16}$

# GRAYCO BUILDING CENTER

WWW.GRAYCOINC.COM

BLUFFTON  
345 BUCK ISLAND RD, BLUFFTON SC 29910  
(843) 815-5788 FAX 815-5799

LADY'S ISLAND  
20 SAMS POINT WAY, BEAUFORT SC 29907  
(843) 522-9994 FAX 522-9972

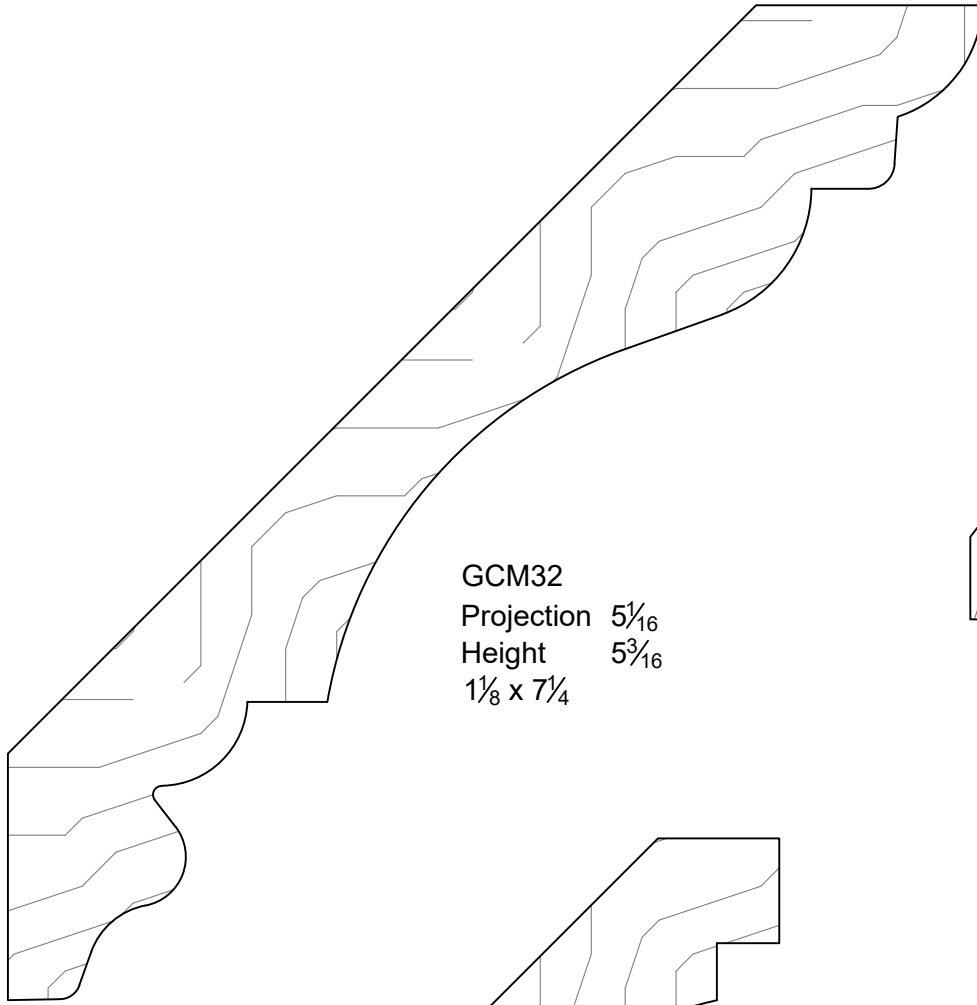

GCM32  
Projection  $5\frac{1}{16}$   
Height  $5\frac{3}{16}$   
 $1\frac{1}{8} \times 7\frac{1}{4}$



GCM57  
Projection 2  
Height  $2\frac{9}{16}$   
 $\frac{5}{8} \times 3\frac{1}{4}$

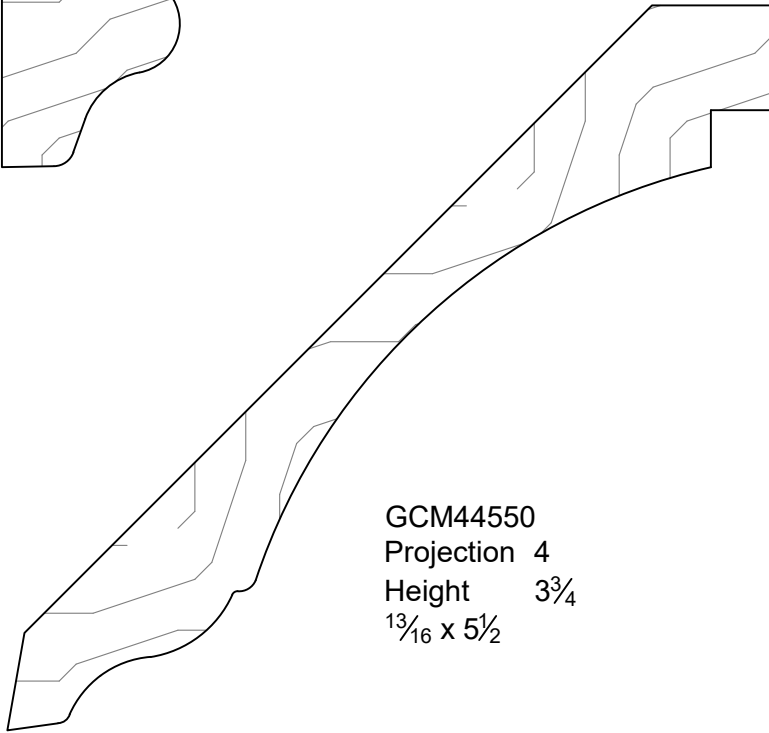

GCM44550  
Projection 4  
Height  $3\frac{3}{4}$   
 $1\frac{3}{16} \times 5\frac{1}{2}$

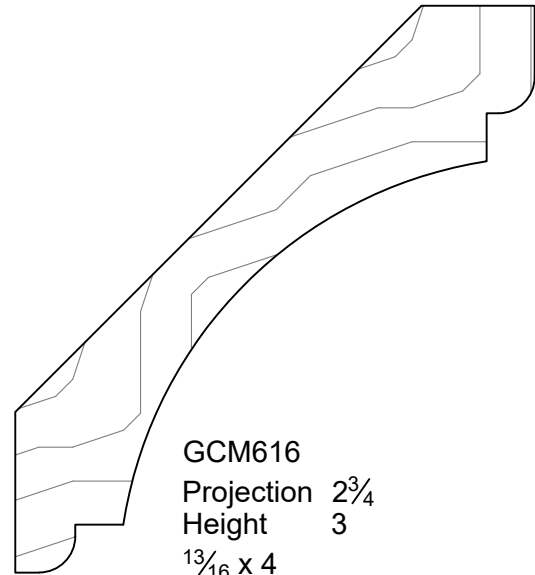

GCM616  
Projection  $2\frac{3}{4}$   
Height 3  
 $1\frac{3}{16} \times 4$

# GRAYCO BUILDING CENTER

WWW.GRAYCOINC.COM

BLUFFTON  
345 BUCK ISLAND RD, BLUFFTON SC 29910  
(843) 815-5788 FAX 815-5799

LADY'S ISLAND  
20 SAMS POINT WAY, BEAUFORT SC 29907  
(843) 522-9994 FAX 522-9972

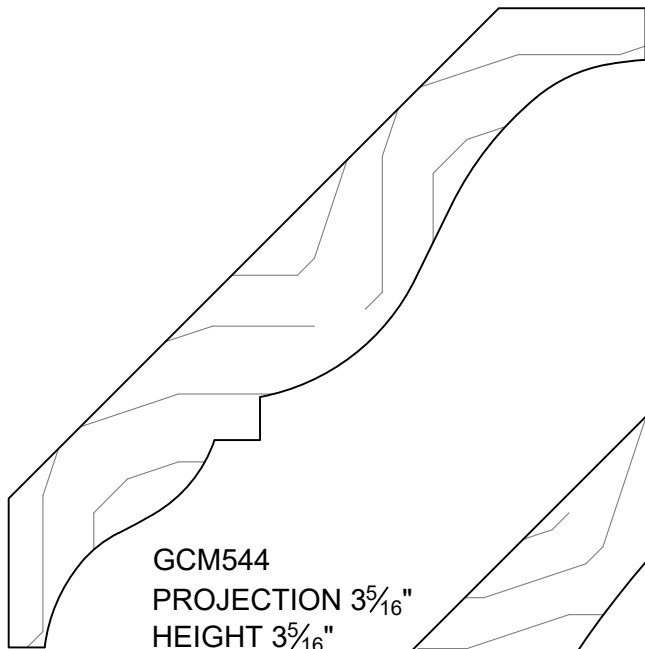

GCM544  
 PROJECTION  $3\frac{5}{16}$ "  
 HEIGHT  $3\frac{5}{16}$ "  
 $\frac{3}{4}$  X  $4\frac{1}{16}$

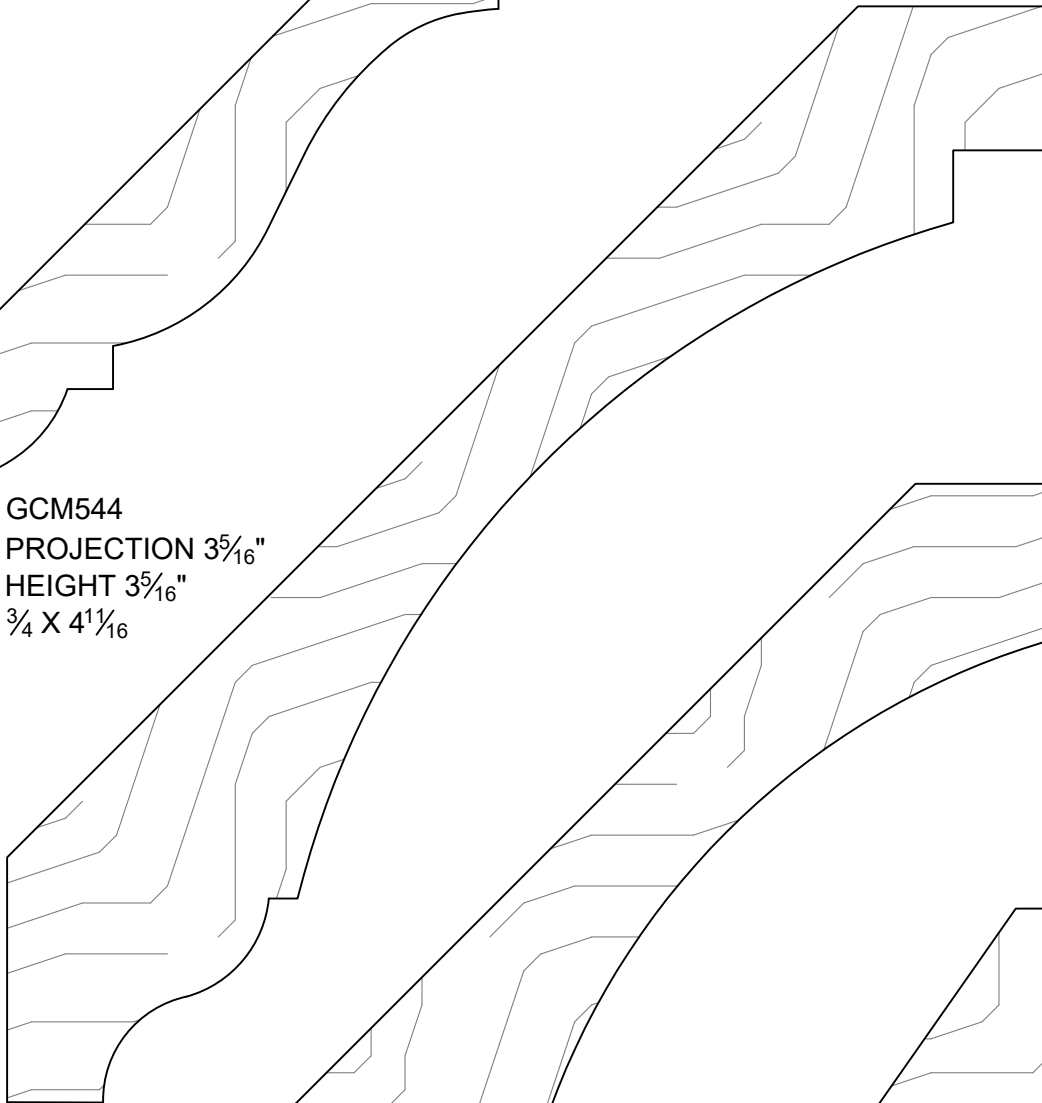

GCM622  
 Projection  $5\frac{7}{16}$ "  
 Height  $5\frac{3}{4}$ "  
 $1\frac{1}{4}$  X  $7\frac{7}{8}$

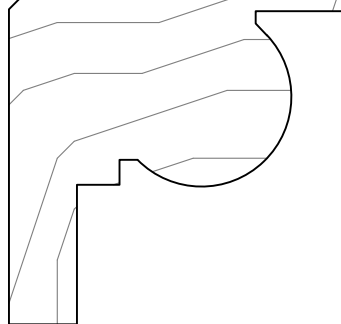

GCM24  
 Projection  $5\frac{1}{2}$ "  
 Height  $5\frac{1}{2}$ "  
 $1\frac{1}{2}$  X  $7\frac{3}{4}$

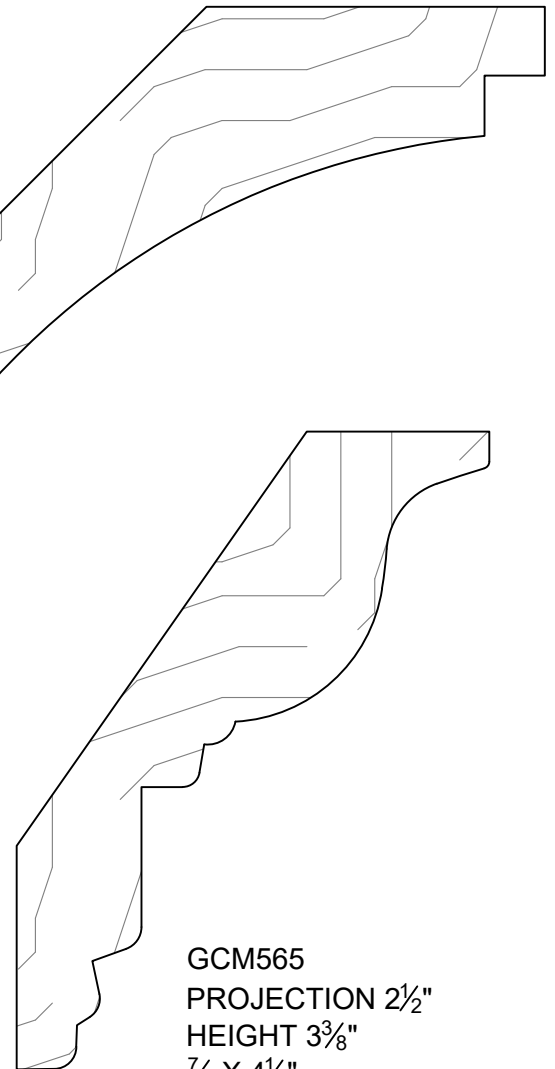

GCM565  
 PROJECTION  $2\frac{1}{2}$ "  
 HEIGHT  $3\frac{3}{8}$ "  
 $\frac{7}{8}$  X  $4\frac{1}{8}$ "

# GRAYCO BUILDING CENTER

WWW.GRAYCOINC.COM

BLUFFTON  
 345 BUCK ISLAND RD, BLUFFTON SC 29910  
 (843) 815-5788 FAX 815-5799

LADY'S ISLAND  
 20 SAMS POINT WAY, BEAUFORT SC 29907  
 (843) 522-9994 FAX 522-9972

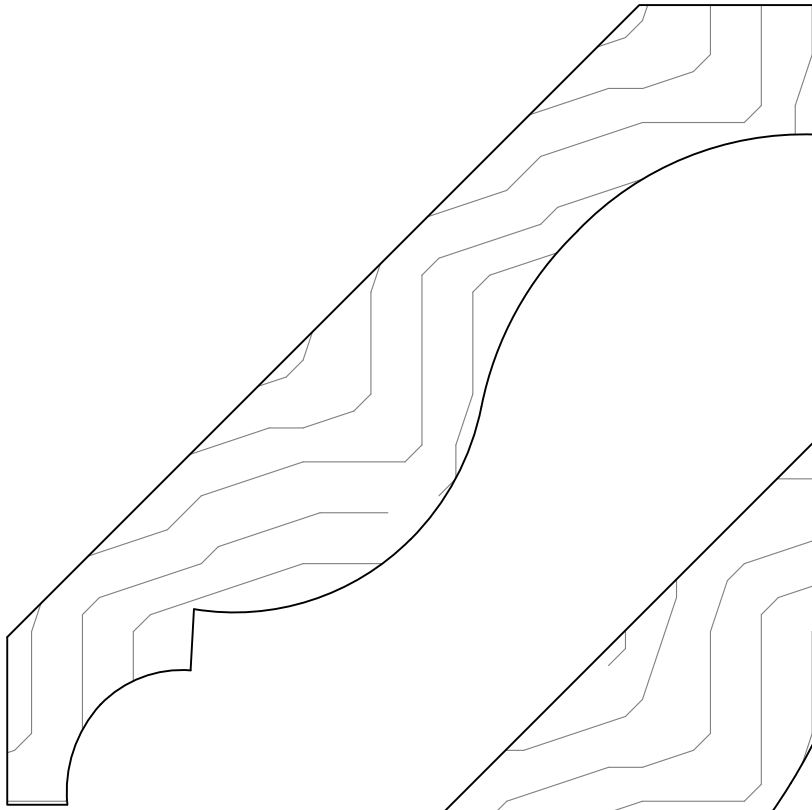

GCM1010  
 Projection  $4\frac{3}{16}$   
 Height  $4\frac{3}{16}$   
 $1\frac{1}{8} \times 5\frac{15}{16}$



GCM1143  
 Projection  $6\frac{1}{4}$   
 Height  $6\frac{1}{2}$   
 $1\frac{1}{4} \times 9$

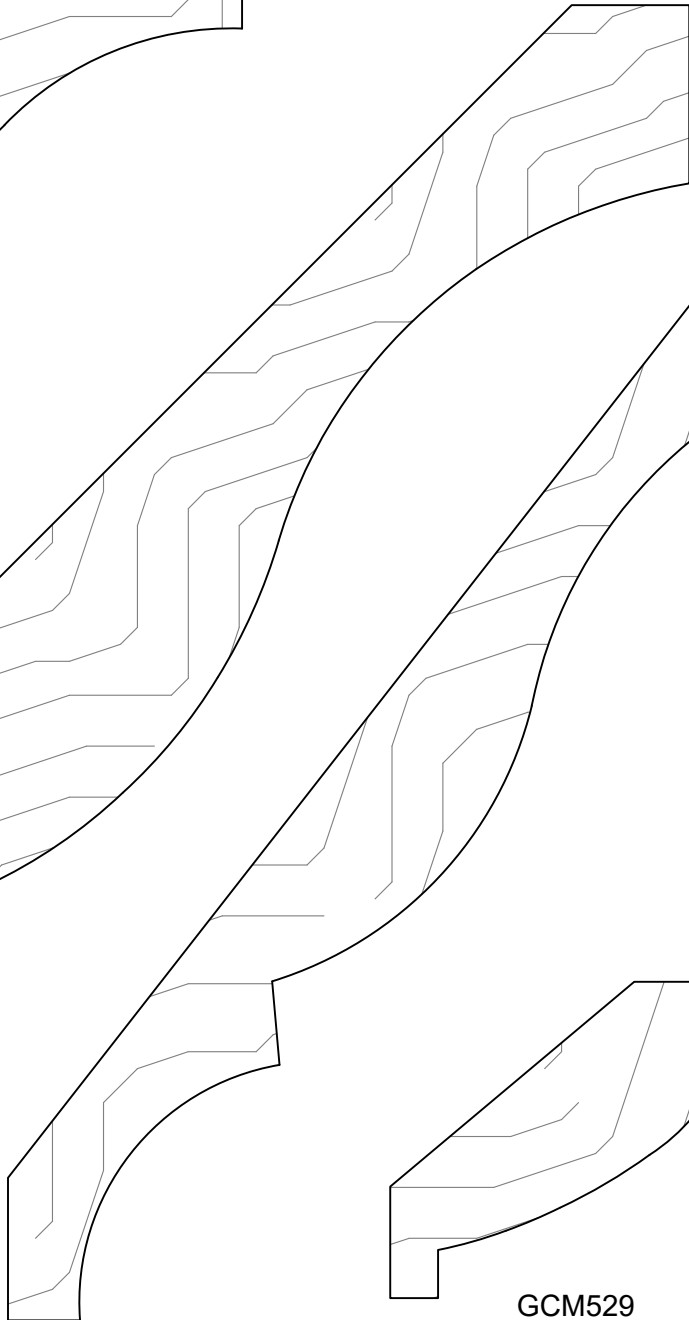

GCM44681  
 Projection  $4\frac{1}{4}$   
 Height  $4\frac{7}{16}$   
 $1\frac{3}{16} \times 6\frac{7}{8}$

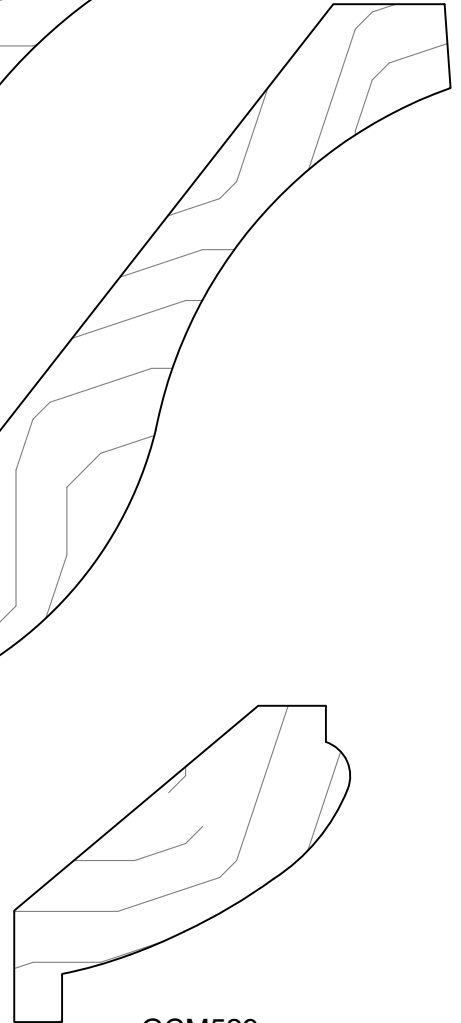

GCM529  
 Projection  $1\frac{5}{8}$   
 Height  $1\frac{5}{8}$   
 $\frac{3}{4} \times 2\frac{5}{16}$

# GRAYCO BUILDING CENTER

WWW.GRAYCOINC.COM

BLUFFTON  
 345 BUCK ISLAND RD, BLUFFTON SC 29910  
 (843) 815-5788 FAX 815-5799

LADY'S ISLAND  
 20 SAMS POINT WAY, BEAUFORT SC 29907  
 (843) 522-9994 FAX 522-9972



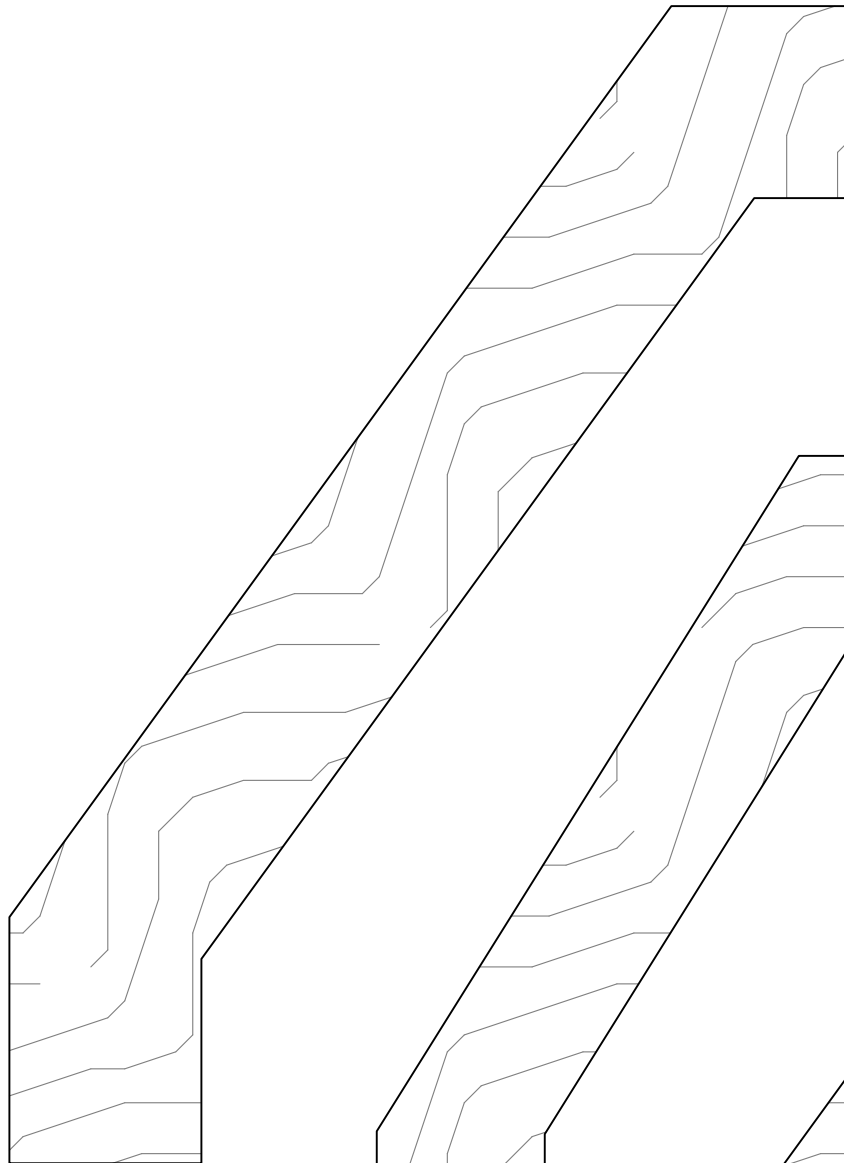

GCM614  
PROJECTION  $4\frac{3}{8}$ "  
HEIGHT 6"  
 $1\frac{9}{16}$ " X  $7\frac{7}{16}$ "

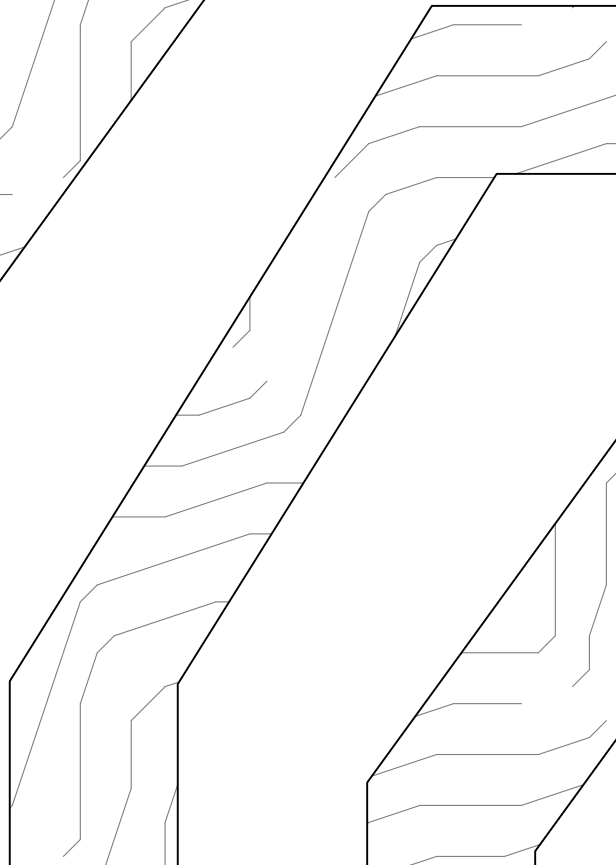

GCM613  
PROJECTION  $3\frac{1}{4}$ "  
HEIGHT  $4\frac{1}{2}$ "  
 $1\frac{5}{16}$ " X  $5\frac{1}{2}$ "

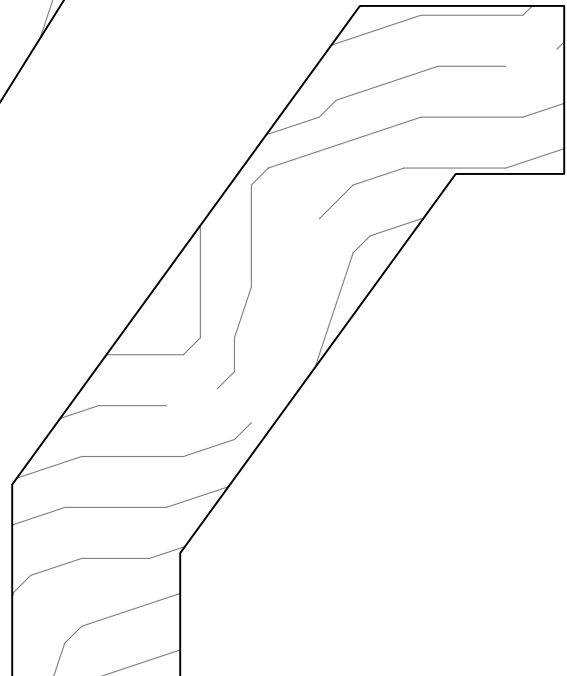

GCM618  
PROJECTION  $2\frac{7}{8}$ "  
HEIGHT  $3\frac{1}{2}$ "  
 $1\frac{3}{8}$ " X  $4\frac{1}{2}$ "

## GRAYCO BUILDING CENTER

[WWW.GRAYCOINC.COM](http://WWW.GRAYCOINC.COM)

BLUFFTON  
345 BUCK ISLAND RD, BLUFFTON SC 29910  
(843) 815-5788 FAX 815-5799

LADY'S ISLAND  
20 SAMS POINT WAY, BEAUFORT SC 29907  
(843) 522-9994 FAX 522-9972

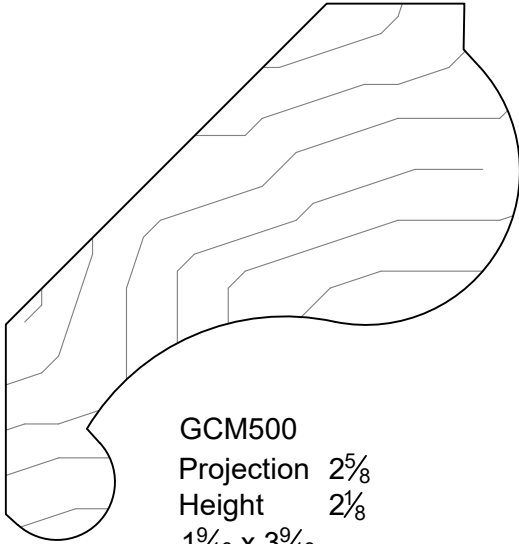

GCM500  
 Projection  $2\frac{5}{8}$   
 Height  $2\frac{1}{8}$   
 $1\frac{9}{16} \times 3\frac{9}{19}$

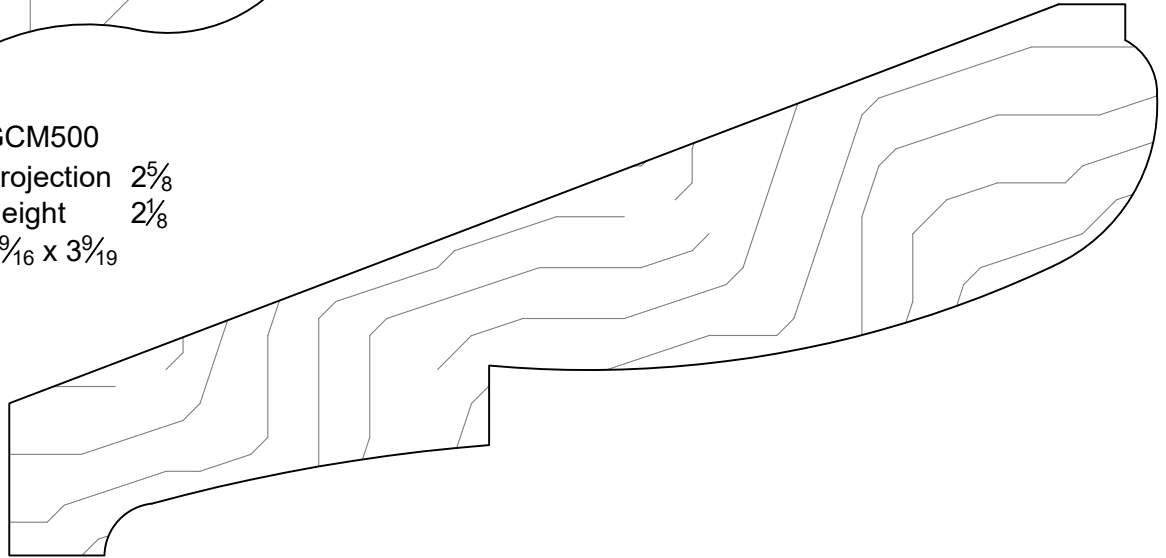

GCM501  
 Projection  $5\frac{1}{16}$   
 Height  $2\frac{7}{8}$   
 $1\frac{1}{4} \times 6\frac{1}{2}$

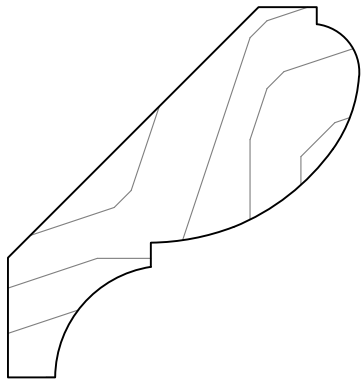

GCM967  
 Projection  $1\frac{13}{16}$   
 Height  $1\frac{15}{16}$   
 $1\frac{3}{16} \times 2\frac{1}{2}$

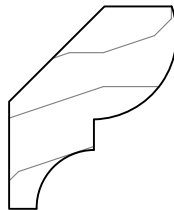

GCM1112  
 Projection  $\frac{7}{8}$   
 Height  $1\frac{1}{16}$   
 $\frac{1}{2} \times 1\frac{11}{32}$

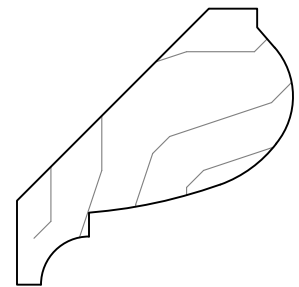

GCM537  
 PROJECTION  $1\frac{1}{4}$ "  
 HEIGHT  $1\frac{7}{16}$ "  
 $\frac{3}{4} \times 2$

# GRAYCO BUILDING CENTER

WWW.GRAYCOINC.COM

BLUFFTON  
 345 BUCK ISLAND RD, BLUFFTON SC 29910  
 (843) 815-5788 FAX 815-5799

LADY'S ISLAND  
 20 SAMS POINT WAY, BEAUFORT SC 29907  
 (843) 522-9994 FAX 522-9972

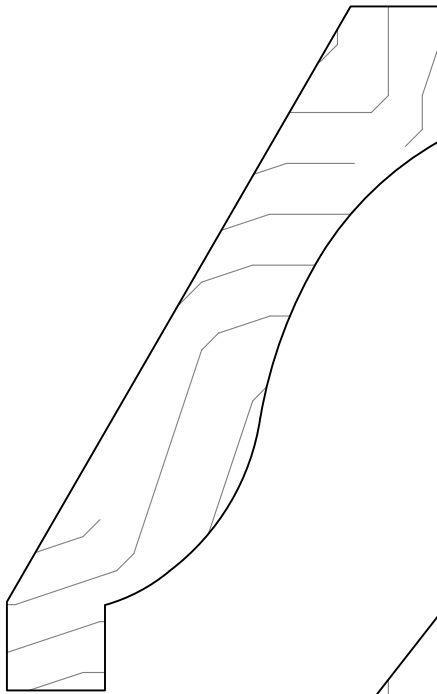

GCM505  
Projection  $2\frac{1}{4}$   
Height  $3\frac{9}{16}$   
 $\frac{3}{4} \times 4\frac{1}{4}$

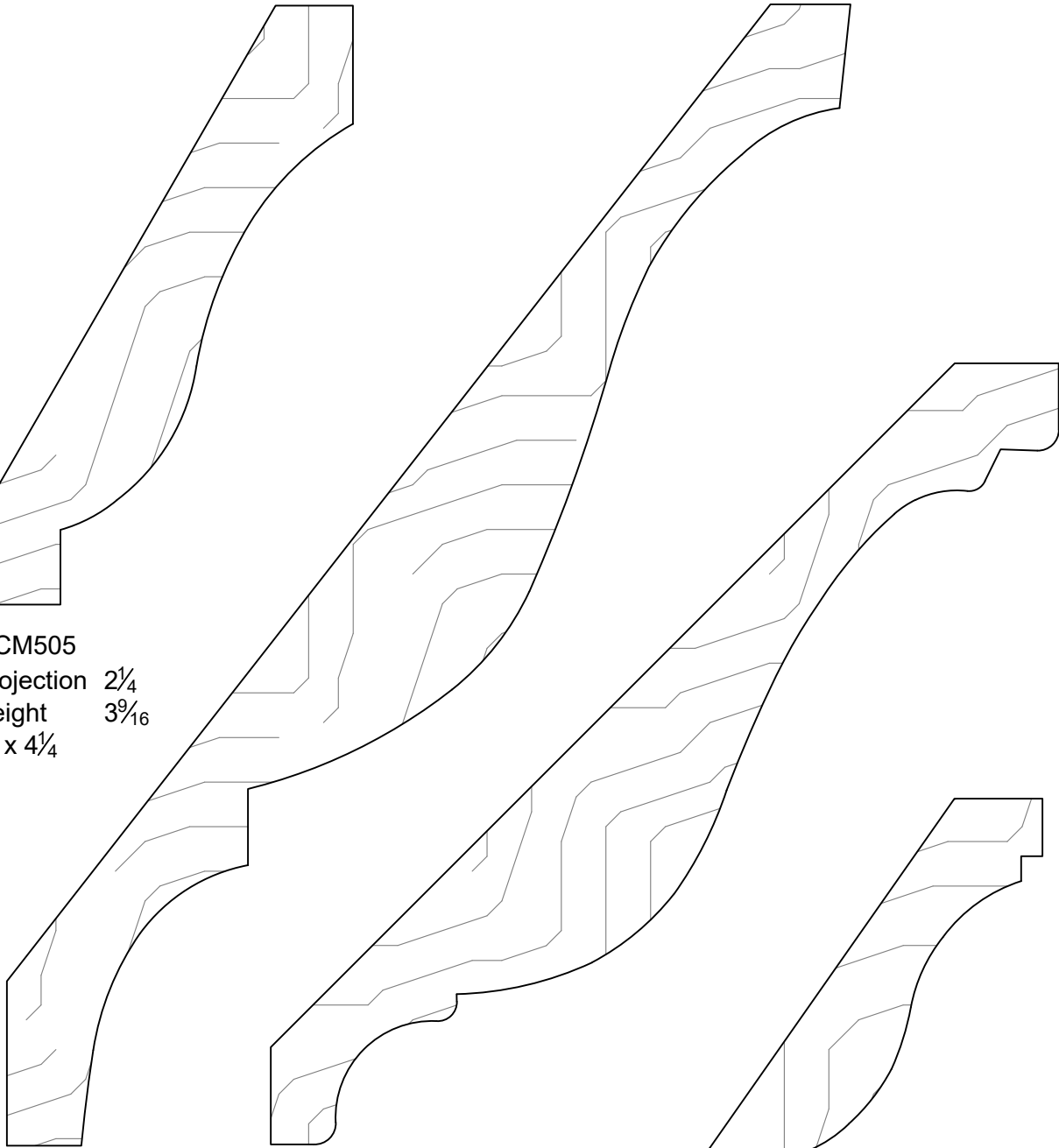

GCM504  
Projection 5  
Height  $6\frac{3}{4}$   
 $1\frac{1}{8} \times 8\frac{7}{16}$

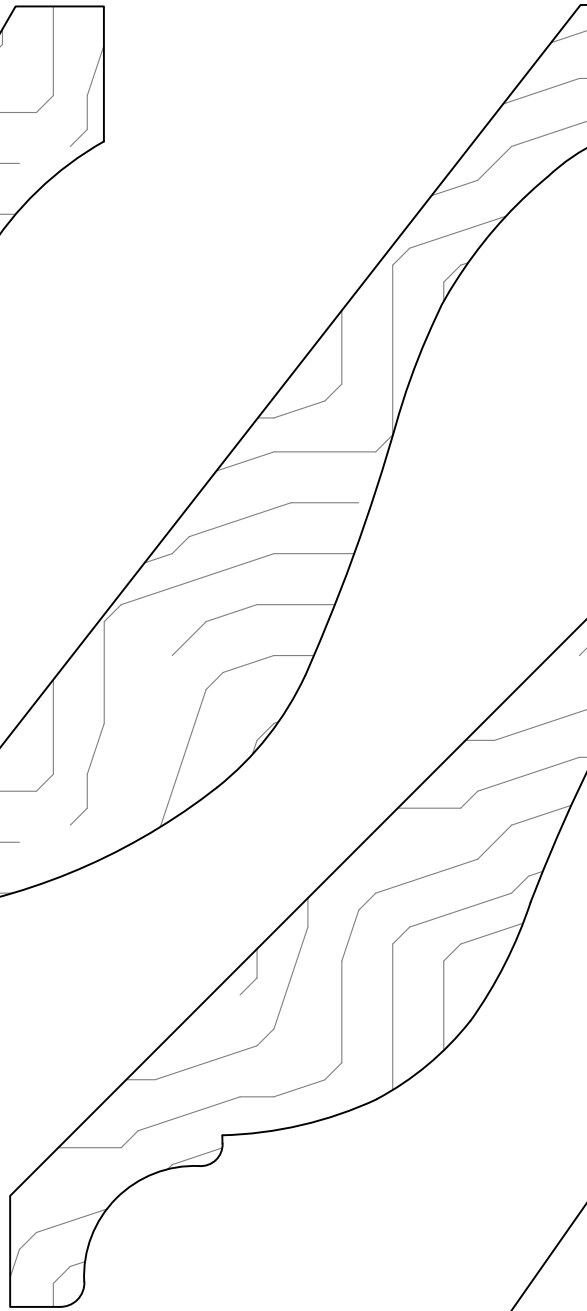

GCM507  
Projection  $4\frac{11}{16}$   
Height  $4\frac{11}{16}$   
 $1\frac{1}{16} \times 6\frac{9}{16}$

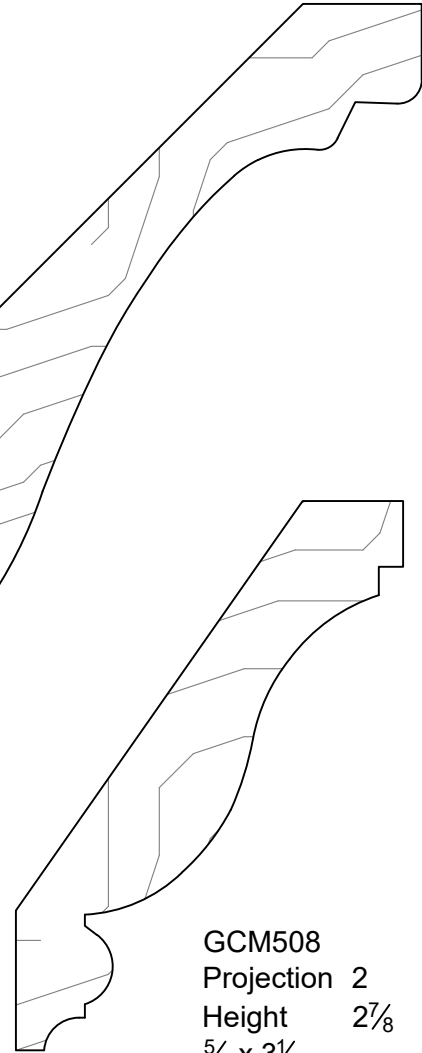

GCM508  
Projection 2  
Height  $2\frac{7}{8}$   
 $\frac{5}{8} \times 3\frac{1}{2}$

# GRAYCO BUILDING CENTER

WWW.GRAYCOINC.COM

BLUFFTON  
345 BUCK ISLAND RD, BLUFFTON SC 29910  
(843) 815-5788 FAX 815-5799

LADY'S ISLAND  
20 SAMS POINT WAY, BEAUFORT SC 29907  
(843) 522-9994 FAX 522-9972

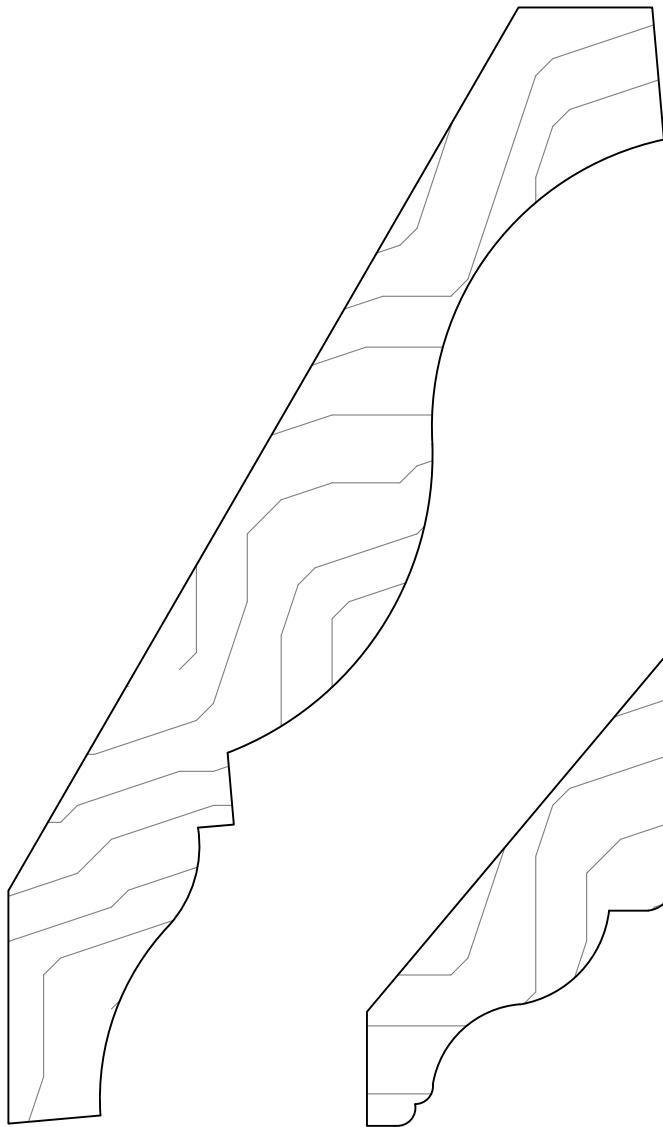

GCM1149  
Projection  $3\frac{3}{8}$   
Height  $5\frac{13}{16}$   
 $1 \times 6\frac{1}{16}$



GCM562  
Projection  $5\frac{3}{16}$   
Height  $5\frac{3}{16}$   
 $1\frac{3}{16} \times 7\frac{5}{16}$

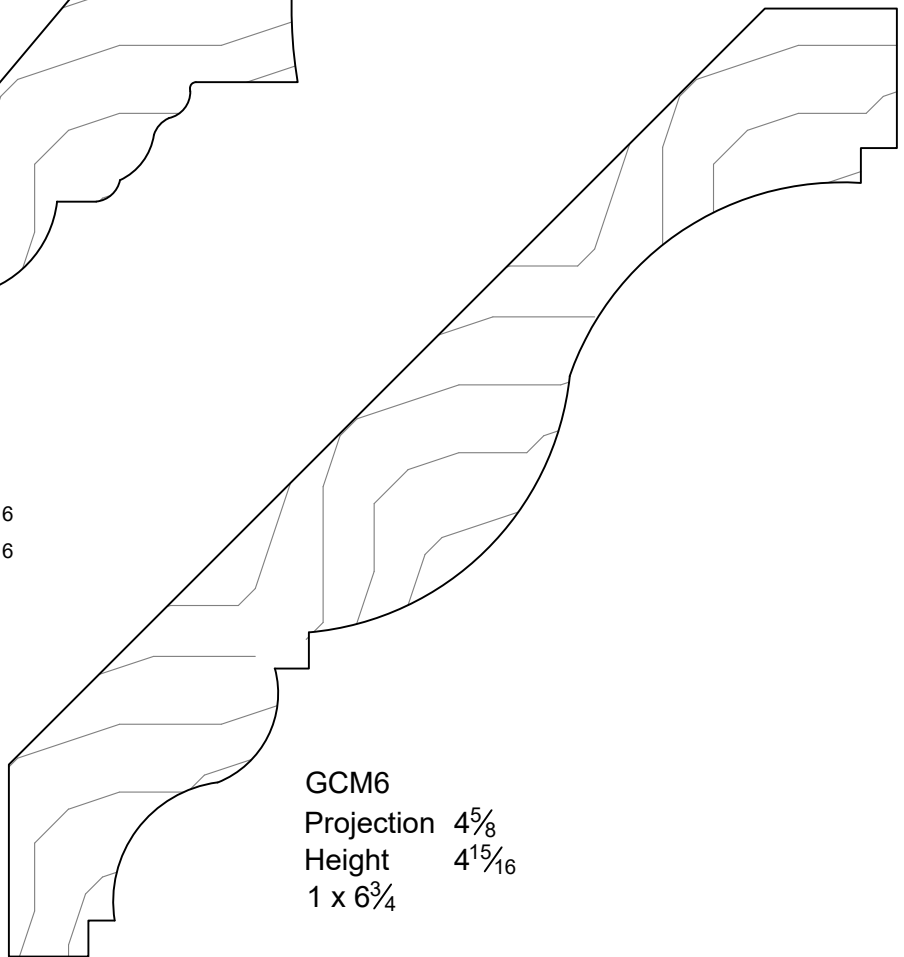

GCM6  
Projection  $4\frac{5}{8}$   
Height  $4\frac{15}{16}$   
 $1 \times 6\frac{3}{4}$

# GRAYCO BUILDING CENTER

WWW.GRAYCOINC.COM

BLUFFTON  
345 BUCK ISLAND RD, BLUFFTON SC 29910  
(843) 815-5788 FAX 815-5799

LADY'S ISLAND  
20 SAMS POINT WAY, BEAUFORT SC 29907  
(843) 522-9994 FAX 522-9972

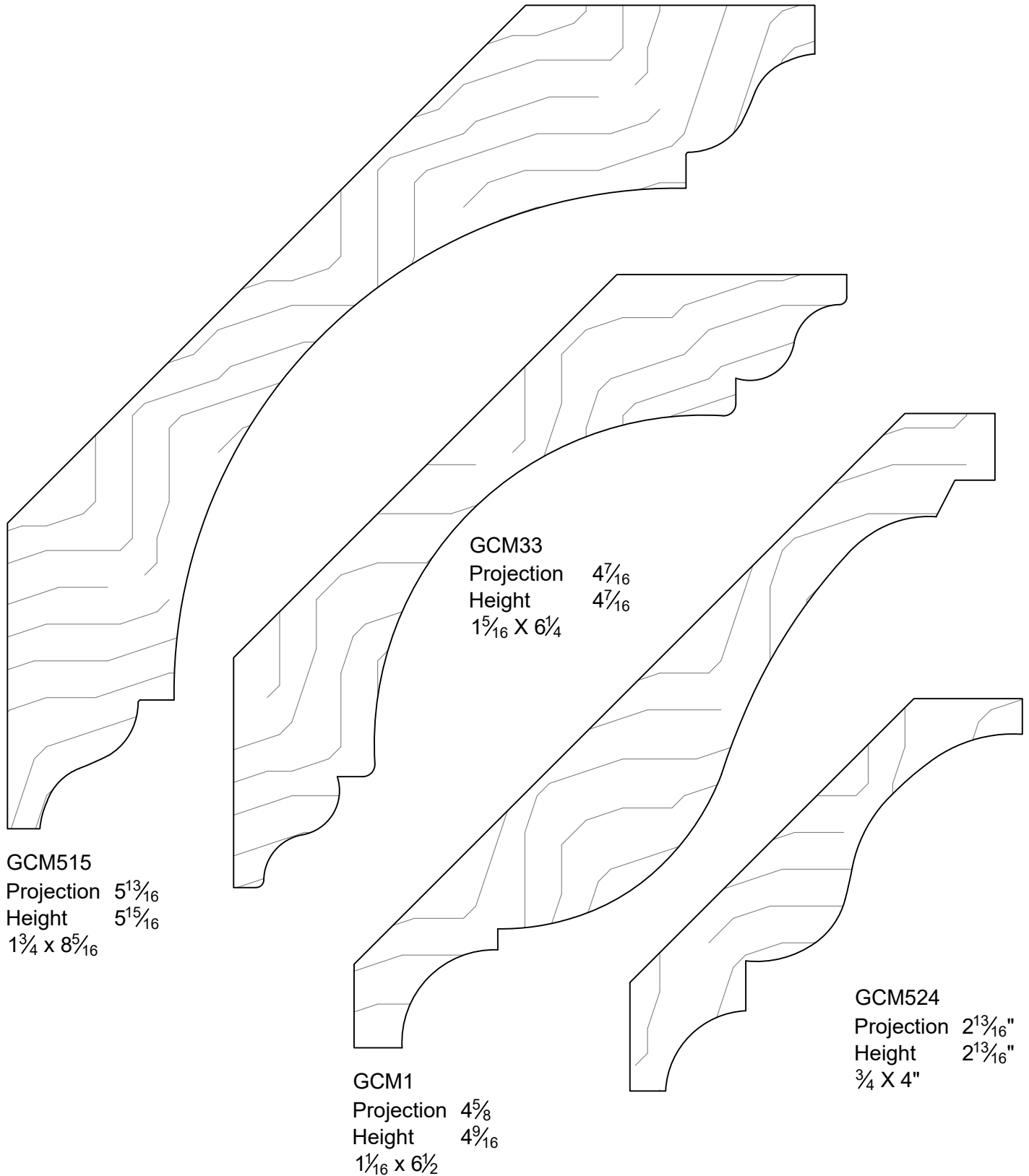

# GRAYCO BUILDING CENTER

WWW.GRAYCOINC.COM

BLUFFTON  
 345 BUCK ISLAND RD, BLUFFTON SC 29910  
 (843) 815-5788 FAX 815-5799

LADY'S ISLAND  
 20 SAMS POINT WAY, BEAUFORT SC 29907  
 (843) 522-9994 FAX 522-9972

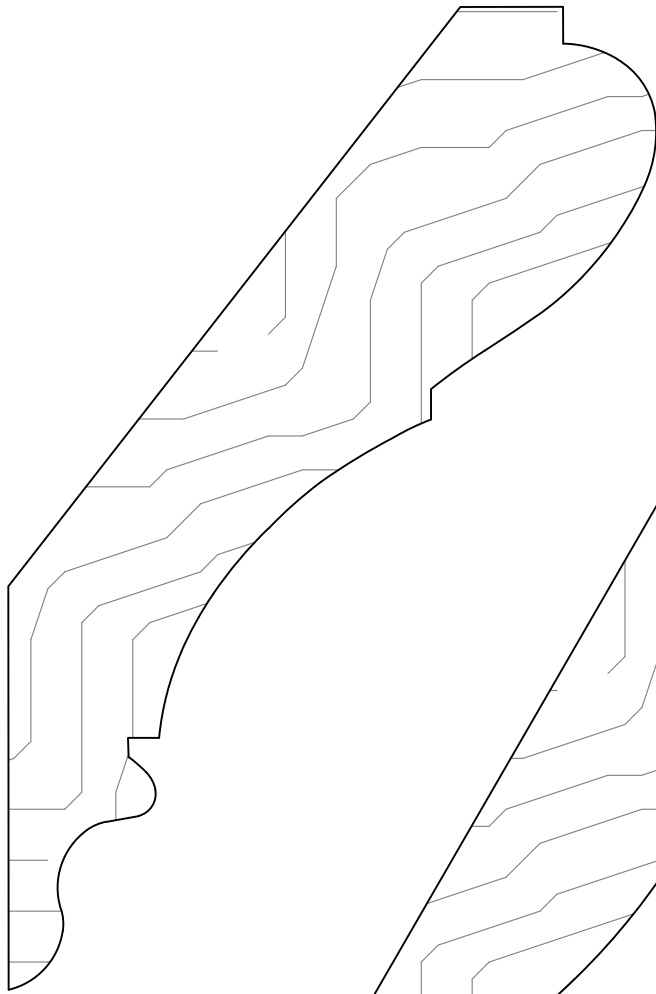

GCM516  
Projection  $3\frac{3}{8}$   
Height  $5\frac{5}{8}$   
 $1\frac{3}{8} \times 5\frac{13}{16}$

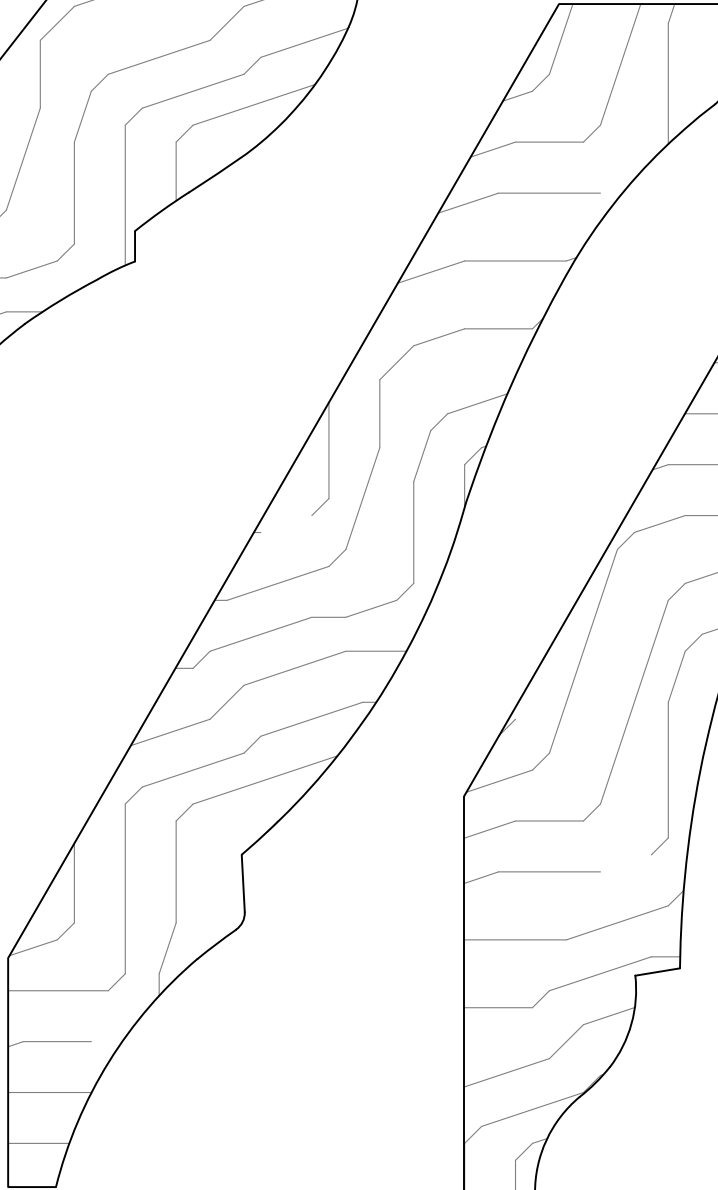

GCM520  
Projection  $3\frac{3}{4}$   
Height  $6\frac{1}{8}$   
 $1 \times 7\frac{3}{16}$

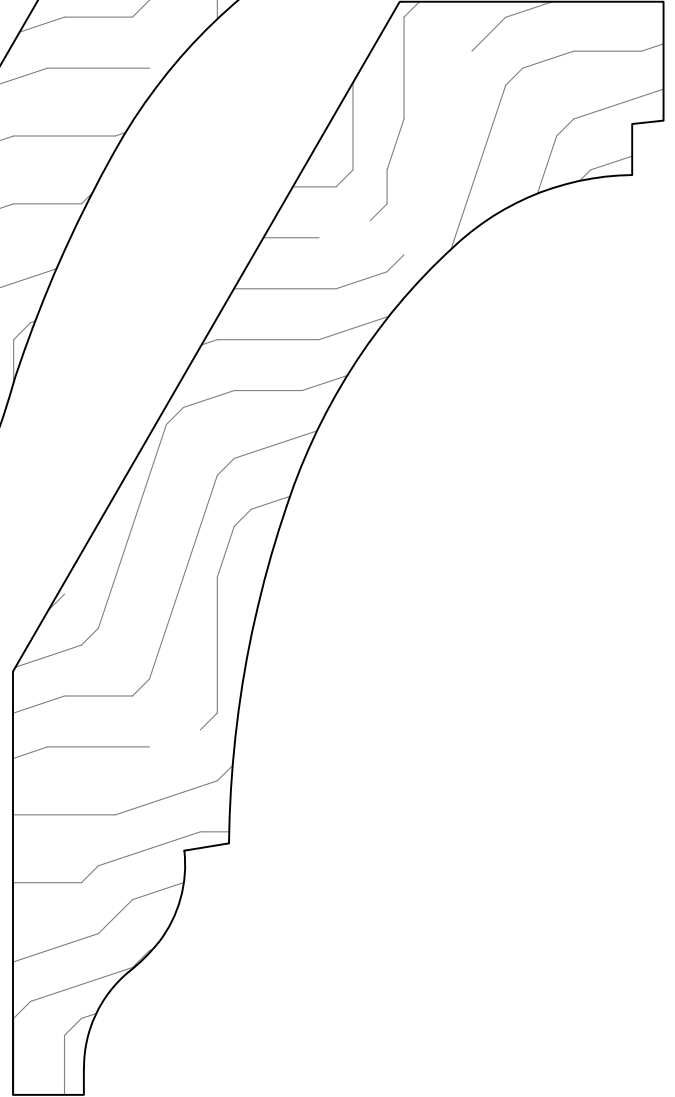

GCM35  
Projection  $3\frac{3}{8}$   
Height  $5\frac{1}{16}$   
 $1\frac{1}{2} \times 6\frac{5}{8}$

# GRAYCO BUILDING CENTER

WWW.GRAYCOINC.COM

BLUFFTON  
345 BUCK ISLAND RD, BLUFFTON SC 29910  
(843) 815-5788 FAX 815-5799

LADY'S ISLAND  
20 SAMS POINT WAY, BEAUFORT SC 29907  
(843) 522-9994 FAX 522-9972

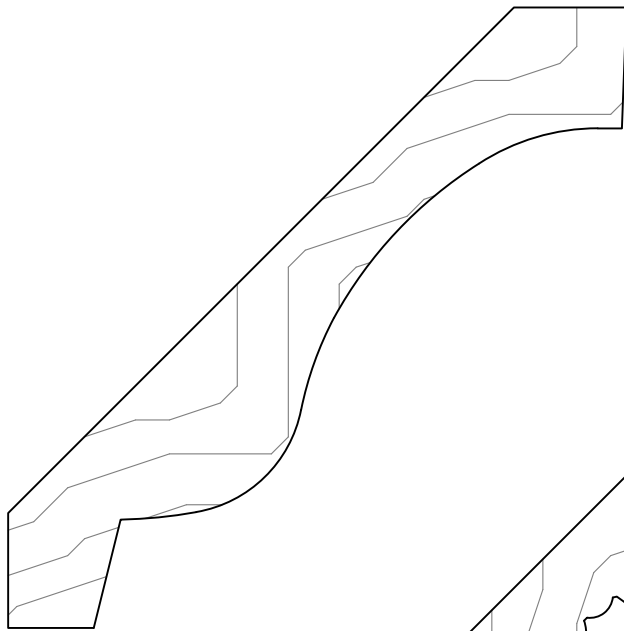

GCM519  
 Projection  $\frac{3}{4}$ "  
 Height  $\frac{3}{4}$ "  
 $\frac{13}{16}$  X  $\frac{9}{16}$

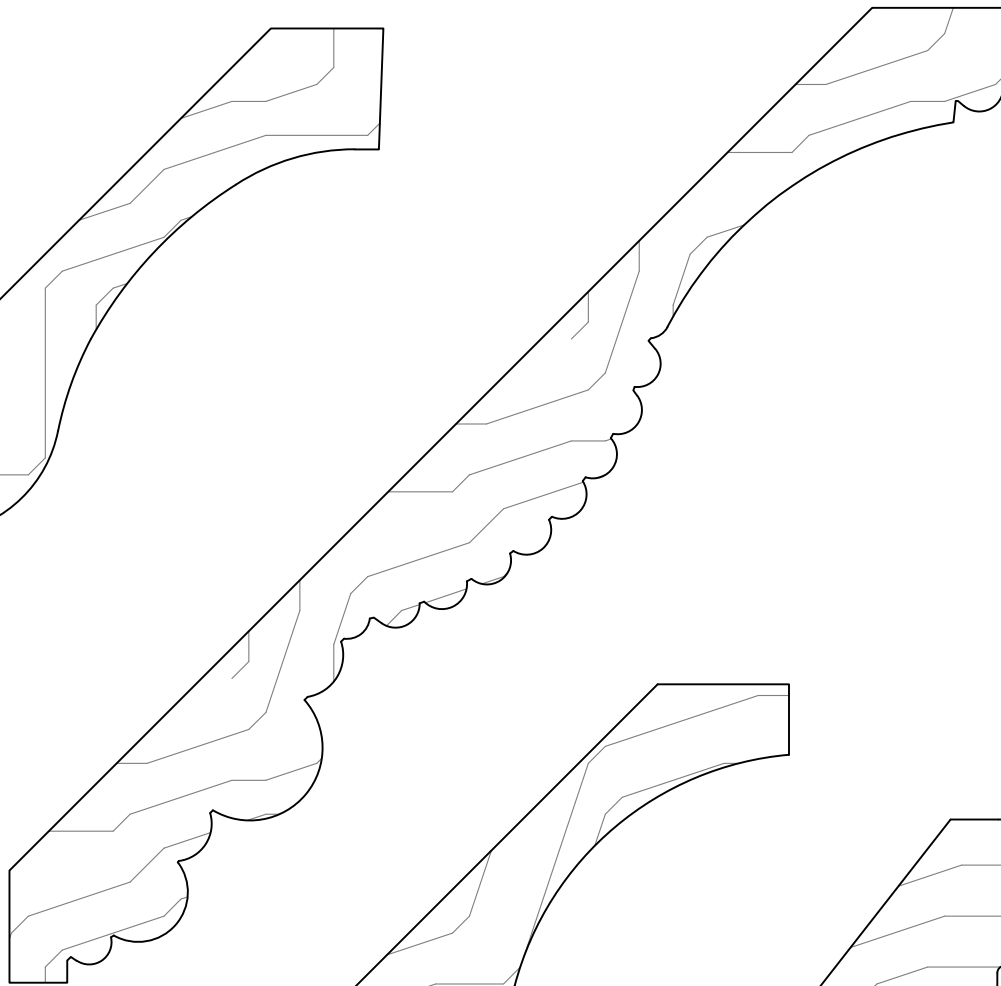

GCM522  
 Projection 5"  
 Height 5"  
 $\frac{3}{4}$  X  $7\frac{1}{4}$ "

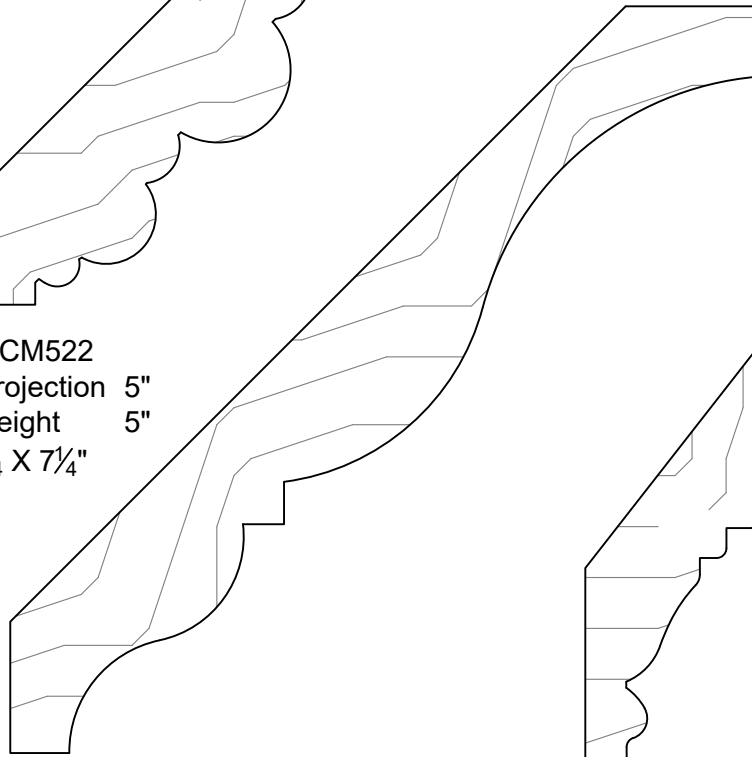

GCM615  
 PROJECTION  $3\frac{7}{8}$ "  
 HEIGHT  $3\frac{7}{8}$ "  
 $\frac{3}{4}$  X  $5\frac{1}{2}$ "

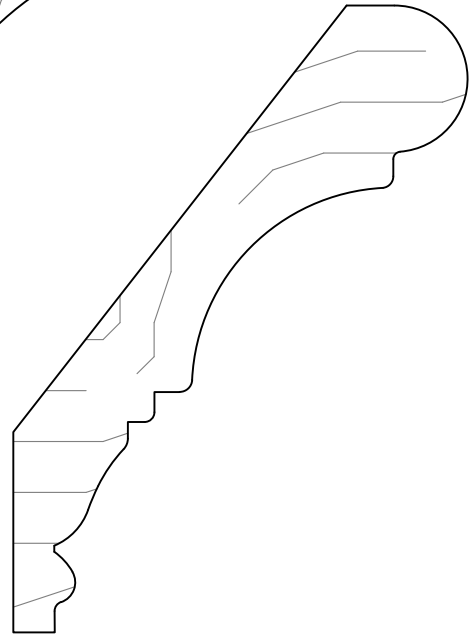

GCM554  
 PROJECTION  $2\frac{3}{8}$ "  
 HEIGHT  $3\frac{1}{4}$ "  
 $\frac{13}{16}$  X  $3\frac{7}{8}$ "

# GRAYCO BUILDING CENTER

WWW.GRAYCOINC.COM

BLUFFTON  
 345 BUCK ISLAND RD, BLUFFTON SC 29910  
 (843) 815-5788 FAX 815-5799

LADY'S ISLAND  
 20 SAMS POINT WAY, BEAUFORT SC 29907  
 (843) 522-9994 FAX 522-9972

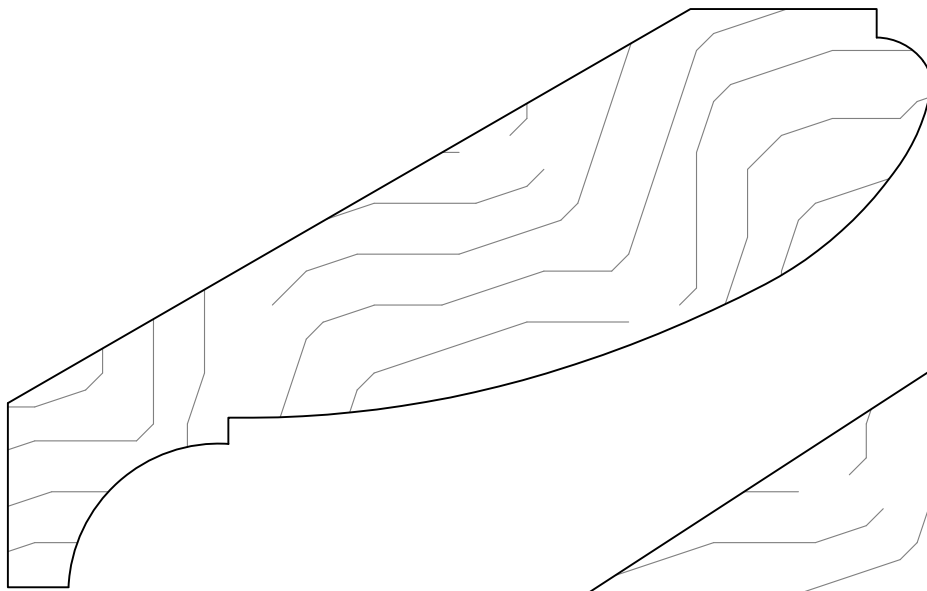

GCM968  
Projection  $4\frac{13}{16}$   
Height 3  
 $1\frac{7}{16} \times 5\frac{1}{2}$

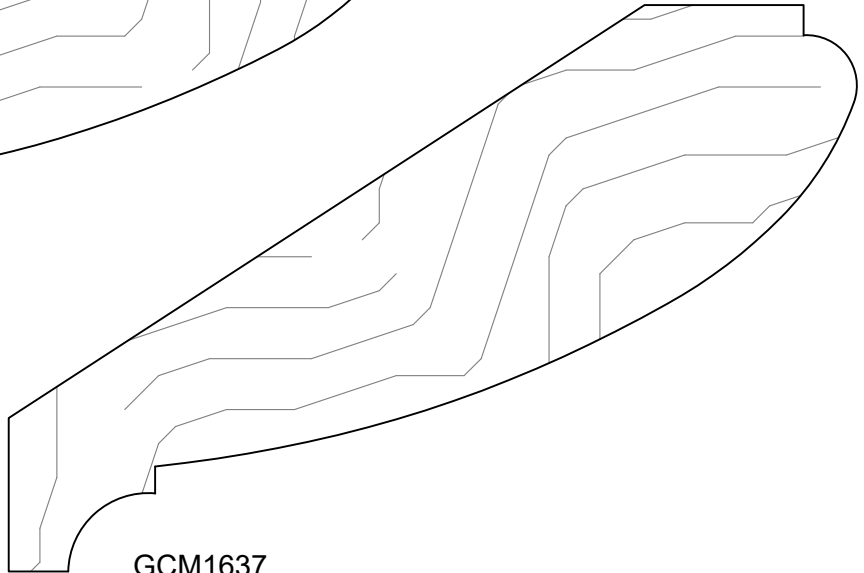

GCM1637  
Projection  $4\frac{7}{16}$   
Height 3  
 $1\frac{3}{8} \times 5\frac{1}{8}$

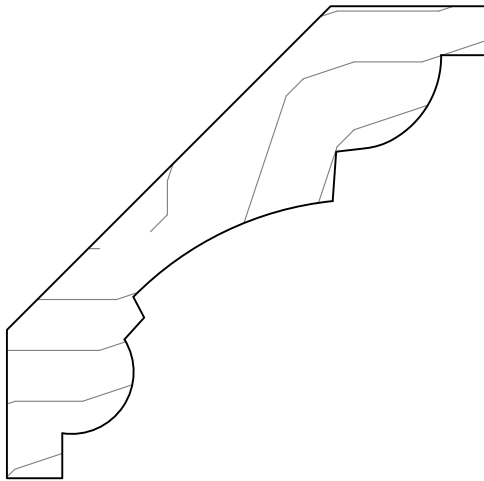

GCM555  
PROJECTION  $2\frac{1}{2}$ "  
HEIGHT  $2\frac{1}{2}$ "  
 $\frac{3}{4} \times 3\frac{1}{2}$ "

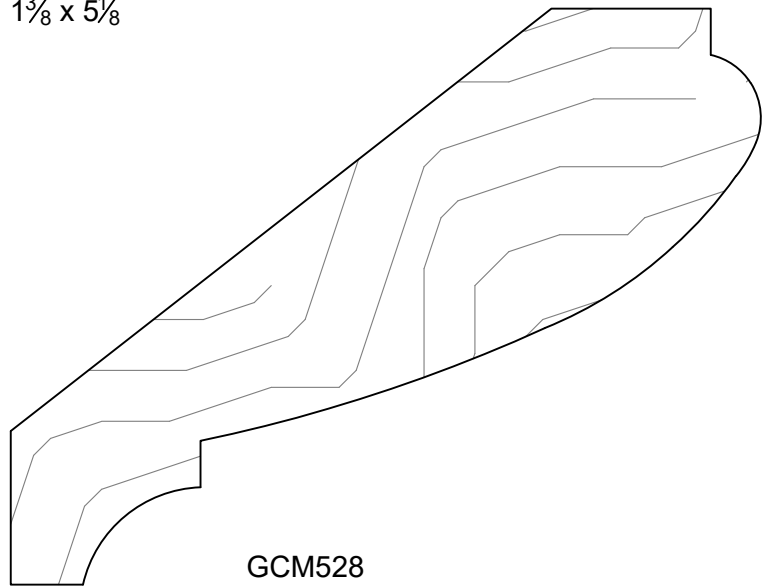

GCM528  
Projection  $3\frac{5}{8}$   
Height 3  
 $1\frac{3}{8} \times 4\frac{3}{4}$

# GRAYCO BUILDING CENTER

WWW.GRAYCOINC.COM

BLUFFTON  
345 BUCK ISLAND RD, BLUFFTON SC 29910  
(843) 815-5788 FAX 815-5799

LADY'S ISLAND  
20 SAMS POINT WAY, BEAUFORT SC 29907  
(843) 522-9994 FAX 522-9972



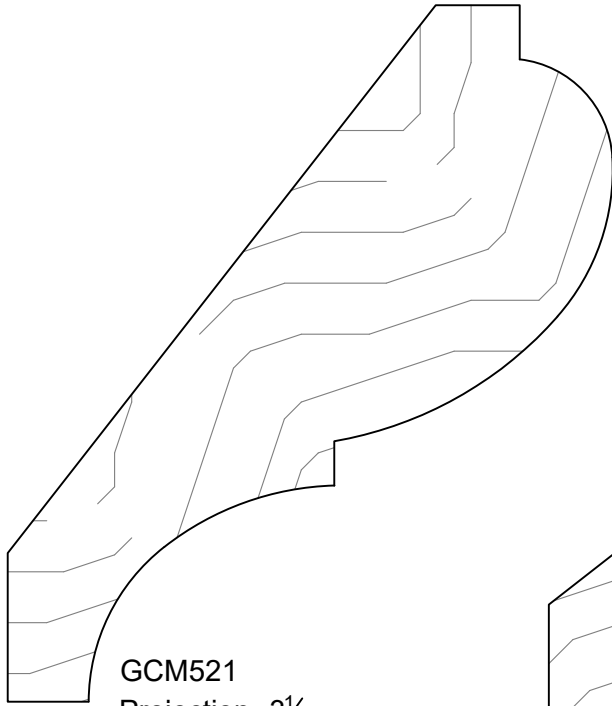

GCM521  
 Projection  $3\frac{1}{8}$   
 Height  $3\frac{5}{8}$   
 $1\frac{1}{2} \times 4\frac{1}{2}$

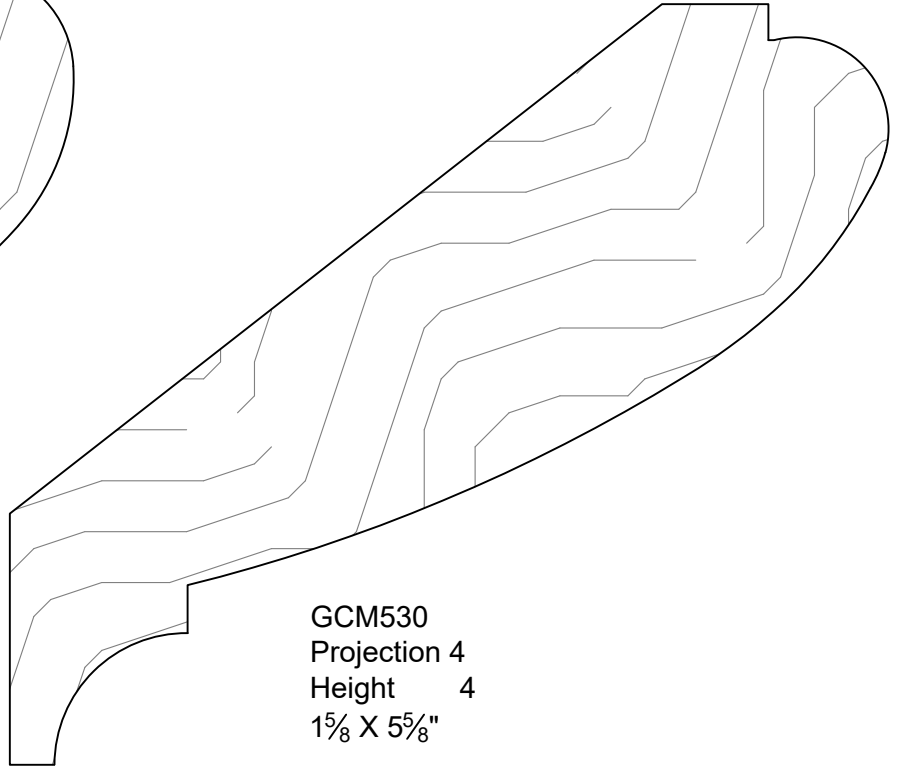

GCM530  
 Projection 4  
 Height 4  
 $1\frac{5}{8} \times 5\frac{5}{8}$ "

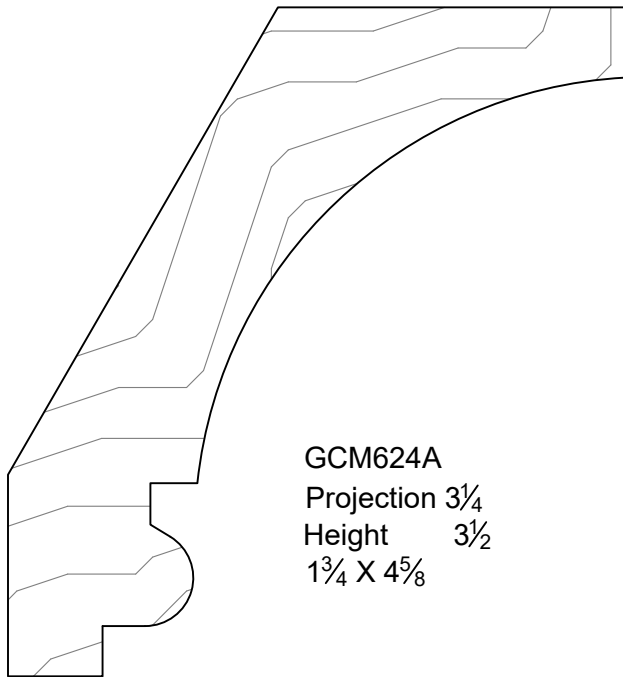

GCM624A  
 Projection  $3\frac{1}{4}$   
 Height  $3\frac{1}{2}$   
 $1\frac{3}{4} \times 4\frac{5}{8}$

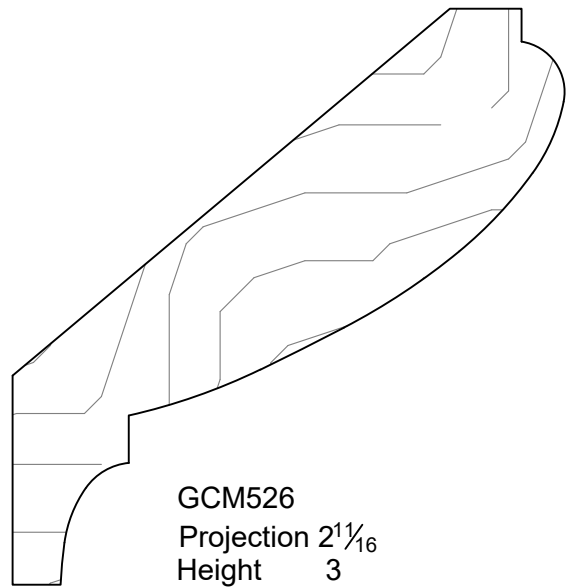

GCM526  
 Projection  $2\frac{1}{16}$   
 Height 3  
 1" X 4"

# GRAYCO BUILDING CENTER

WWW.GRAYCOINC.COM

BLUFFTON  
 345 BUCK ISLAND RD, BLUFFTON SC 29910  
 (843) 815-5788 FAX 815-5799

LADY'S ISLAND  
 20 SAMS POINT WAY, BEAUFORT SC 29907  
 (843) 522-9994 FAX 522-9972

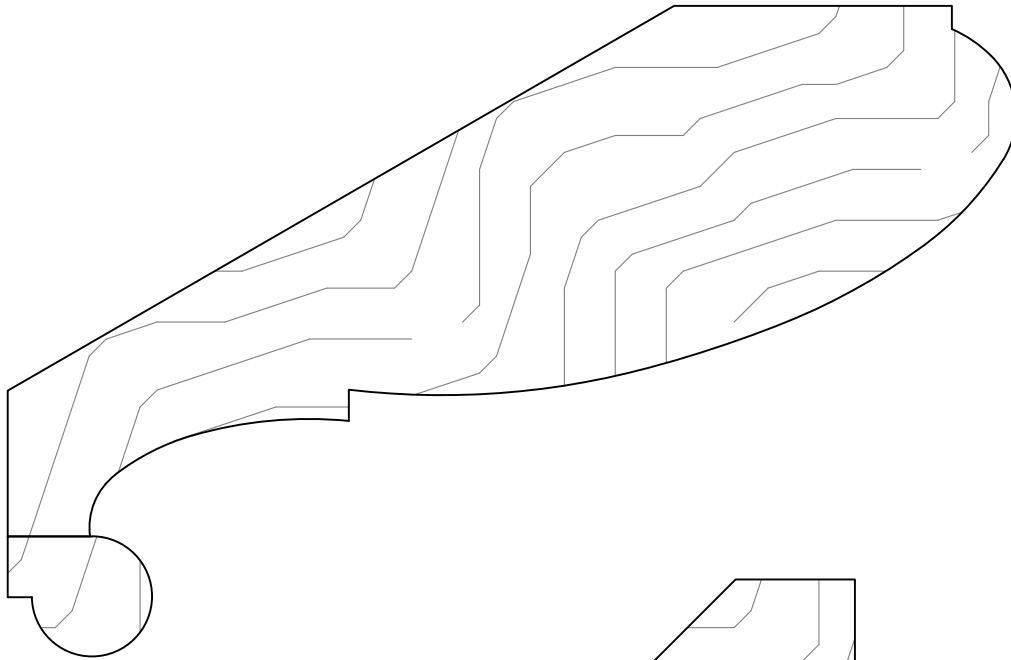

GCM584 (GCM231 PENCIL)  
1<sup>3</sup>/<sub>4</sub> X 5<sup>7</sup>/<sub>8</sub>  
PROJECTION 5<sup>1</sup>/<sub>4</sub>  
HEIGHT 3<sup>3</sup>/<sub>8</sub>

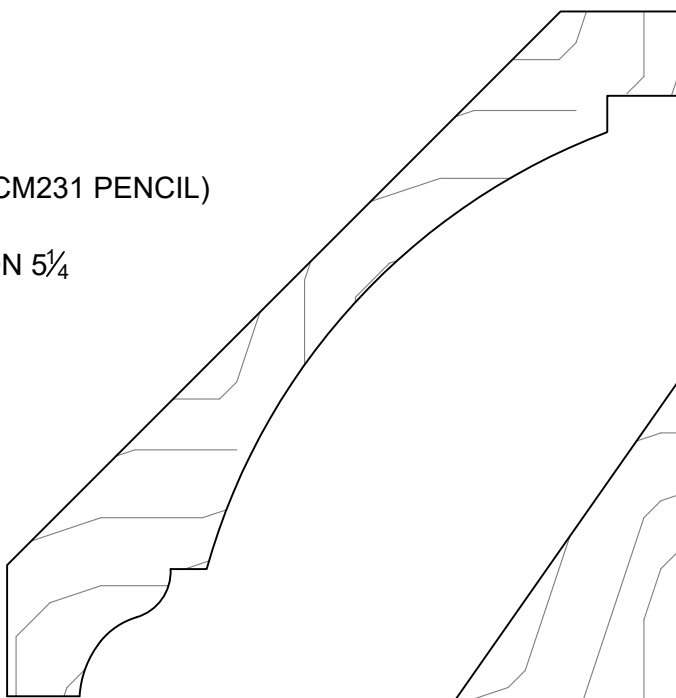

GCM1095  
PROJECTION 3<sup>1</sup>/<sub>2</sub>"  
HEIGHT 3<sup>9</sup>/<sub>16</sub>"  
3/4 X 5

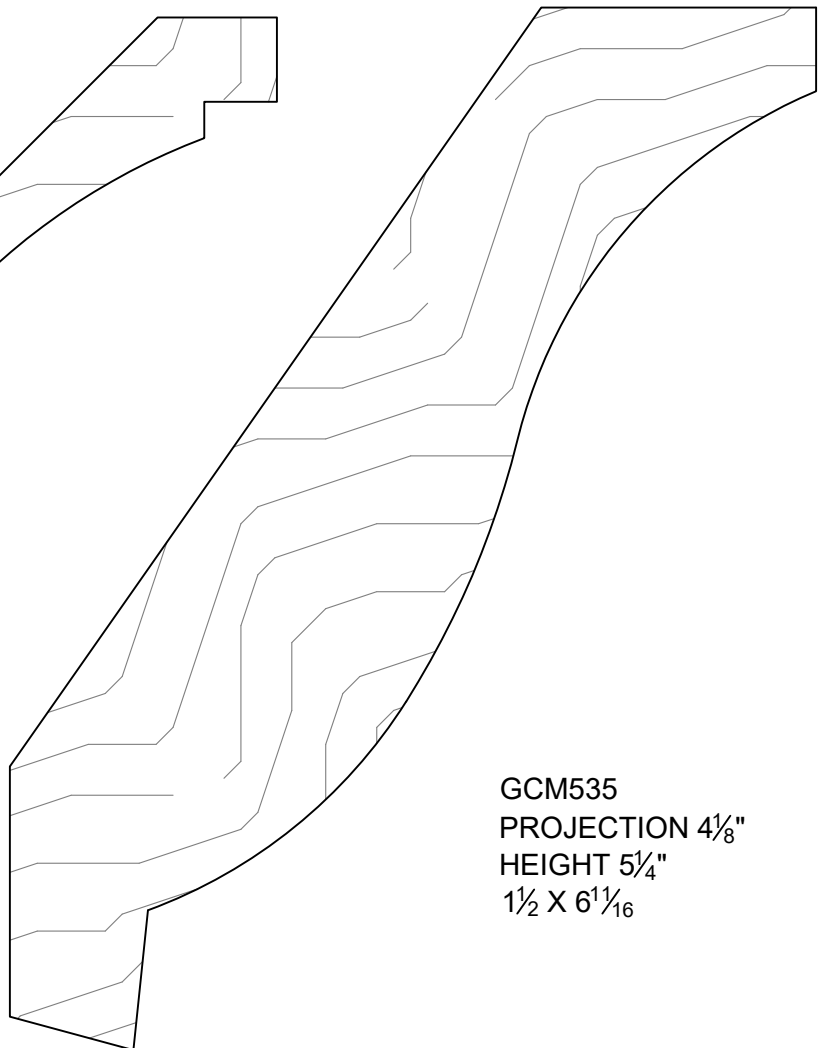

GCM535  
PROJECTION 4<sup>1</sup>/<sub>8</sub>"  
HEIGHT 5<sup>1</sup>/<sub>4</sub>"  
1<sup>1</sup>/<sub>2</sub> X 6<sup>1</sup>/<sub>16</sub>

# GRAYCO BUILDING CENTER

WWW.GRAYCOINC.COM

BLUFFTON  
345 BUCK ISLAND RD, BLUFFTON SC 29910  
(843) 815-5788 FAX 815-5799

LADY'S ISLAND  
20 SAMS POINT WAY, BEAUFORT SC 29907  
(843) 522-9994 FAX 522-9972

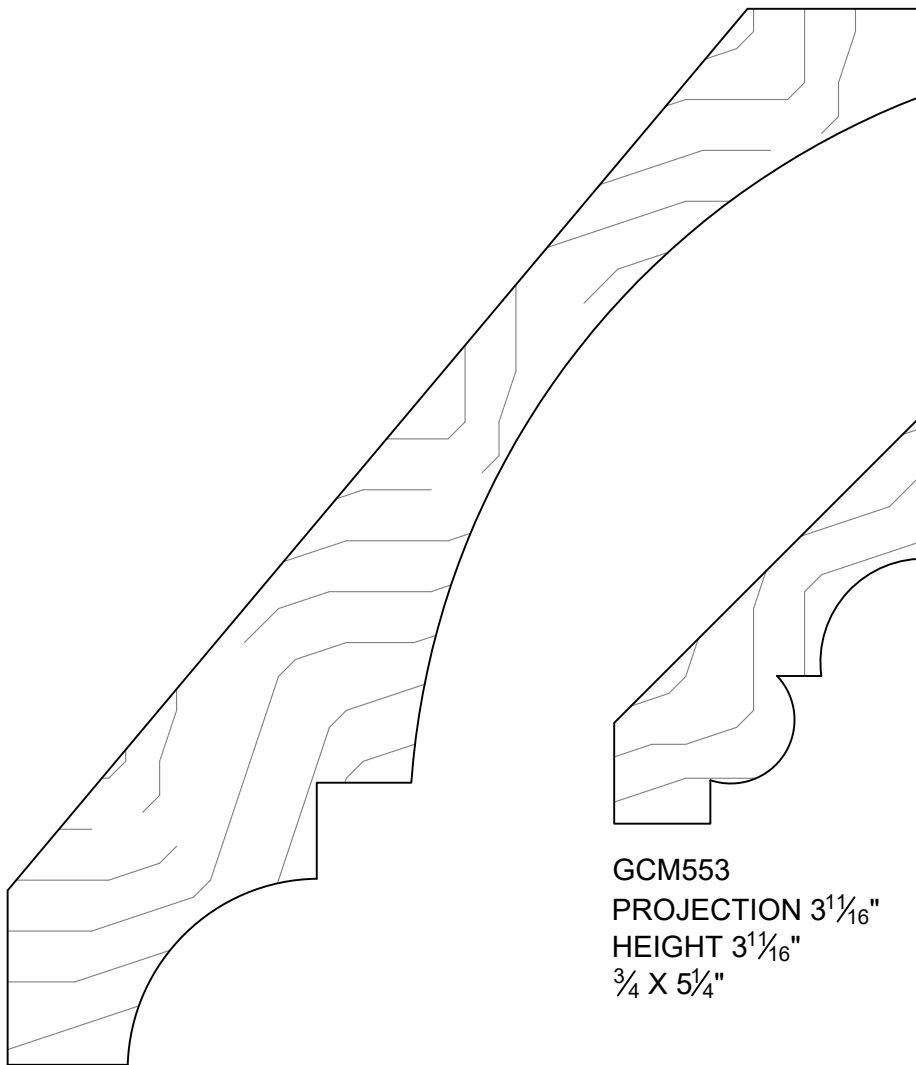

GCM551  
PROJECTION 4 $\frac{3}{4}$ "  
HEIGHT 5 $\frac{1}{2}$ "  
1 $\frac{1}{4}$  X 7 $\frac{5}{16}$ "

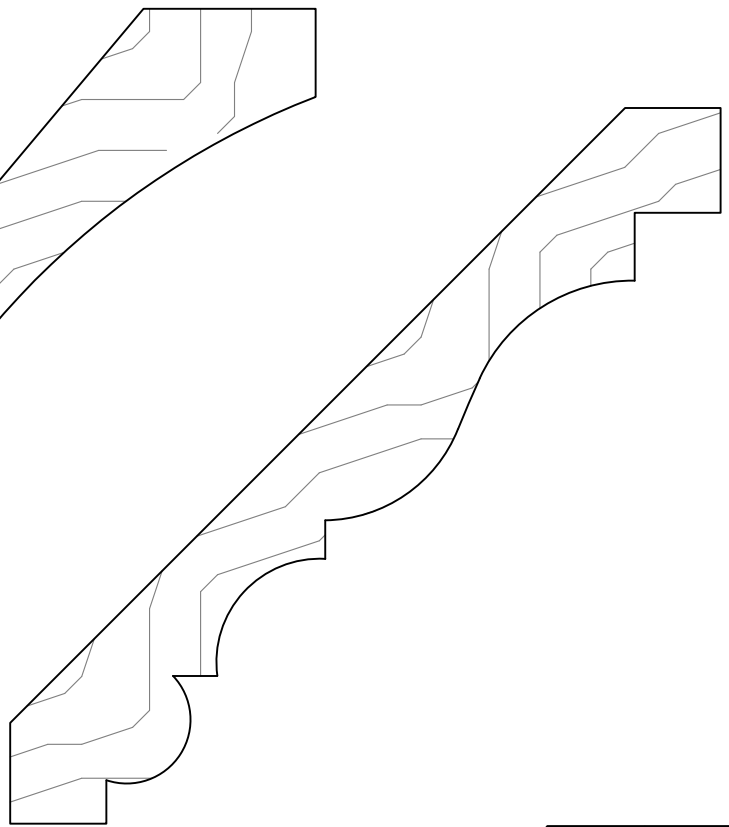

GCM553  
PROJECTION 3 $\frac{1}{16}$ "  
HEIGHT 3 $\frac{1}{16}$ "  
 $\frac{3}{4}$  X 5 $\frac{1}{4}$ "

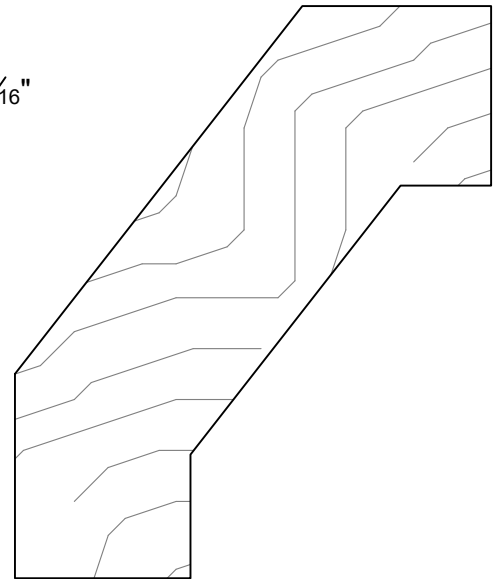

GCM835  
PROJECTION 2 $\frac{1}{2}$ "  
HEIGHT 3"  
1 $\frac{3}{8}$ " X 3 $\frac{7}{8}$ "

# GRAYCO BUILDING CENTER

WWW.GRAYCOINC.COM

BLUFFTON  
345 BUCK ISLAND RD, BLUFFTON SC 29910  
(843) 815-5788 FAX 815-5799

LADY'S ISLAND  
20 SAMS POINT WAY, BEAUFORT SC 29907  
(843) 522-9994 FAX 522-9972

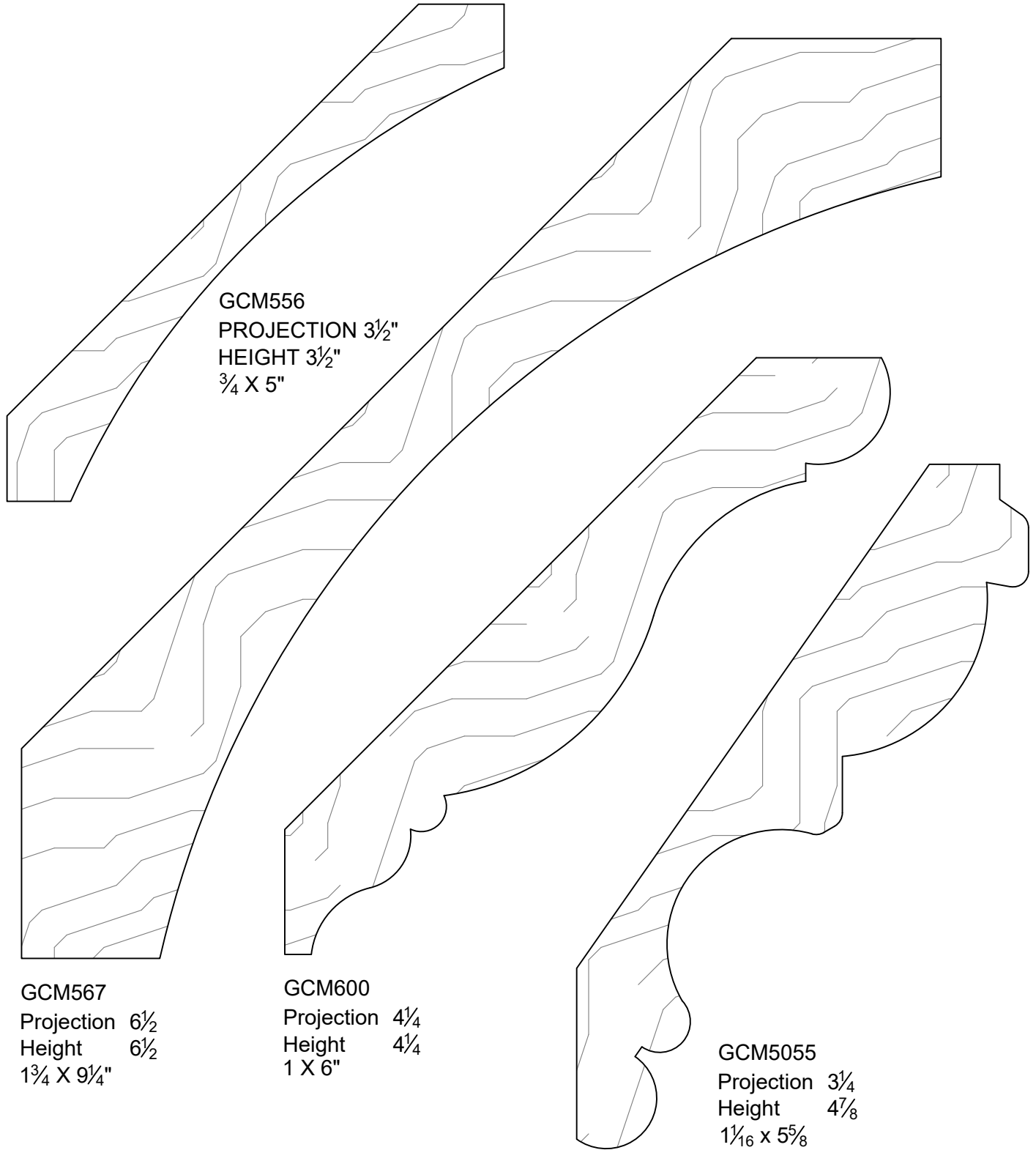

# GRAYCO BUILDING CENTER

WWW.GRAYCOINC.COM

BLUFFTON  
345 BUCK ISLAND RD, BLUFFTON SC 29910  
(843) 815-5788 FAX 815-5799

LADY'S ISLAND  
20 SAMS POINT WAY, BEAUFORT SC 29907  
(843) 522-9994 FAX 522-9972

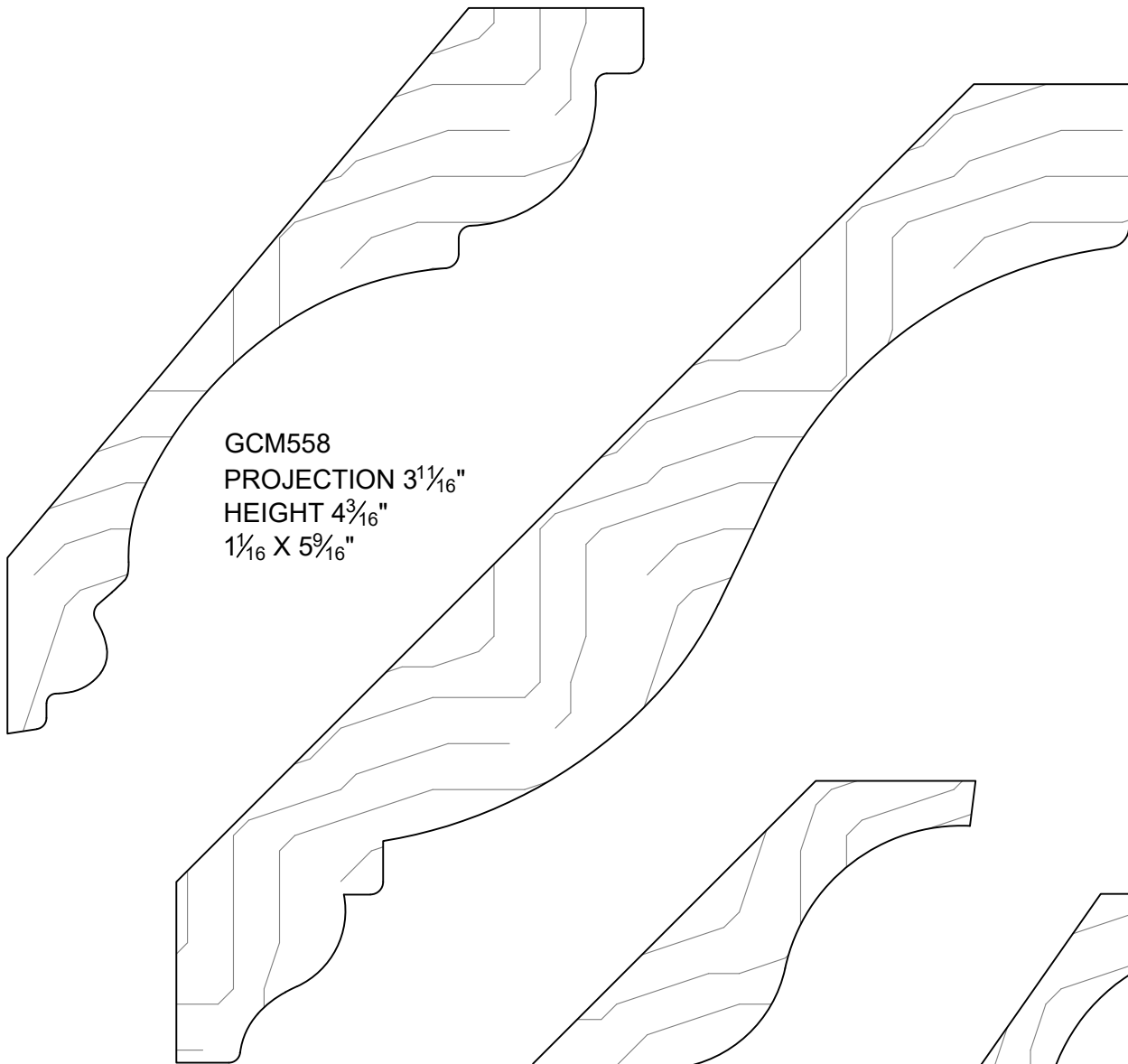

GCM558  
PROJECTION  $3\frac{1}{16}$ "  
HEIGHT  $4\frac{3}{16}$ "  
 $1\frac{1}{16}$  X  $5\frac{9}{16}$ "

GCM560  
PROJECTION  $5\frac{1}{2}$ "  
HEIGHT  $5\frac{5}{8}$ "  
 $1\frac{1}{4}$  X  $7\frac{7}{8}$ "

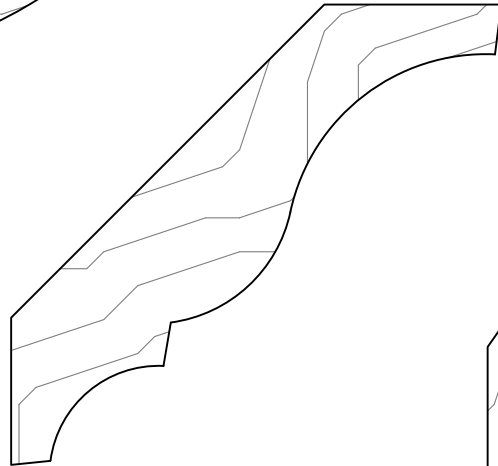

GCM1348  
PROJECTION  $2\frac{9}{16}$ "  
HEIGHT  $2\frac{3}{8}$ "  
 $1\frac{3}{16}$  X  $3\frac{1}{2}$ "

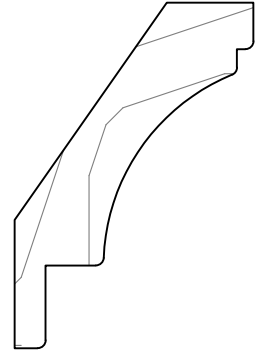

GCM50135  
PROJECTION  $1\frac{1}{4}$ "  
HEIGHT  $1\frac{13}{16}$ "  
 $\frac{1}{2}$  X  $2\frac{3}{16}$ "

# GRAYCO BUILDING CENTER

WWW.GRAYCOINC.COM

BLUFFTON  
345 BUCK ISLAND RD, BLUFFTON SC 29910  
(843) 815-5788 FAX 815-5799

LADY'S ISLAND  
20 SAMS POINT WAY, BEAUFORT SC 29907  
(843) 522-9994 FAX 522-9972

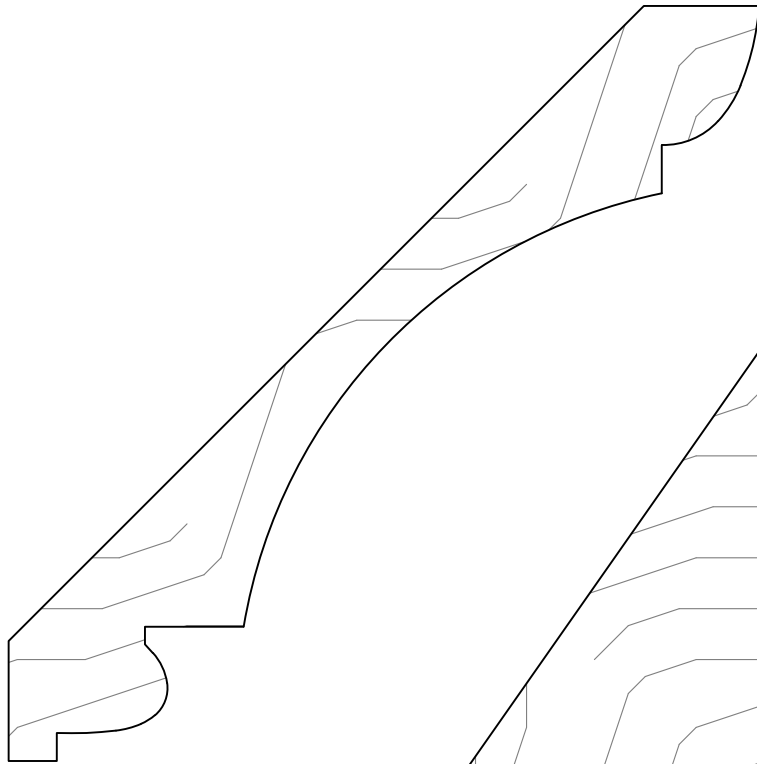

GCM80012  
PROJECTION  $3\frac{15}{16}$ "  
HEIGHT  $3\frac{15}{16}$ "  
 $1\frac{3}{16}$ " x  $5\frac{1}{2}$ "

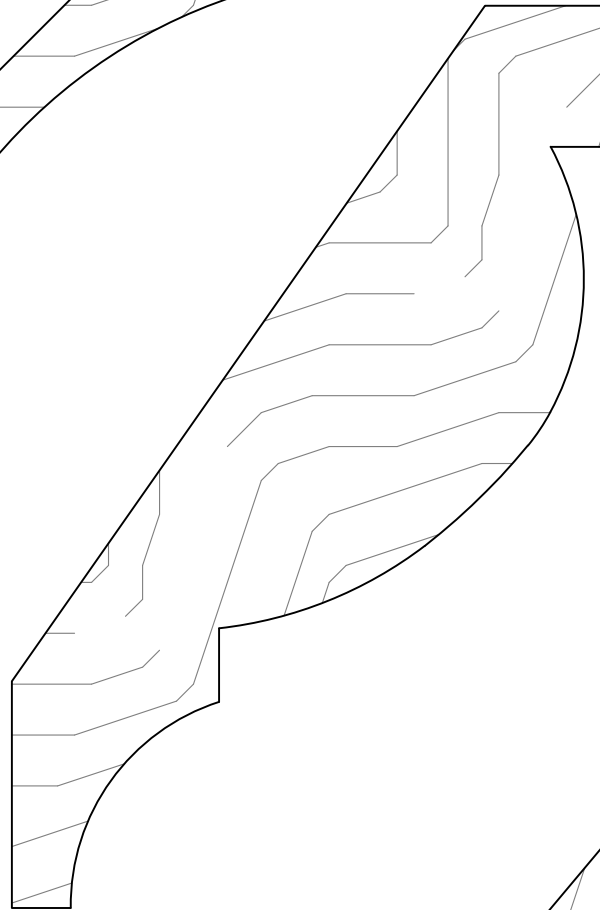

GCM80019  
PROJECTION  $3\frac{1}{16}$ "  
HEIGHT  $4\frac{1}{16}$ "  
 $1\frac{1}{2}$ " x  $5\frac{5}{8}$ "

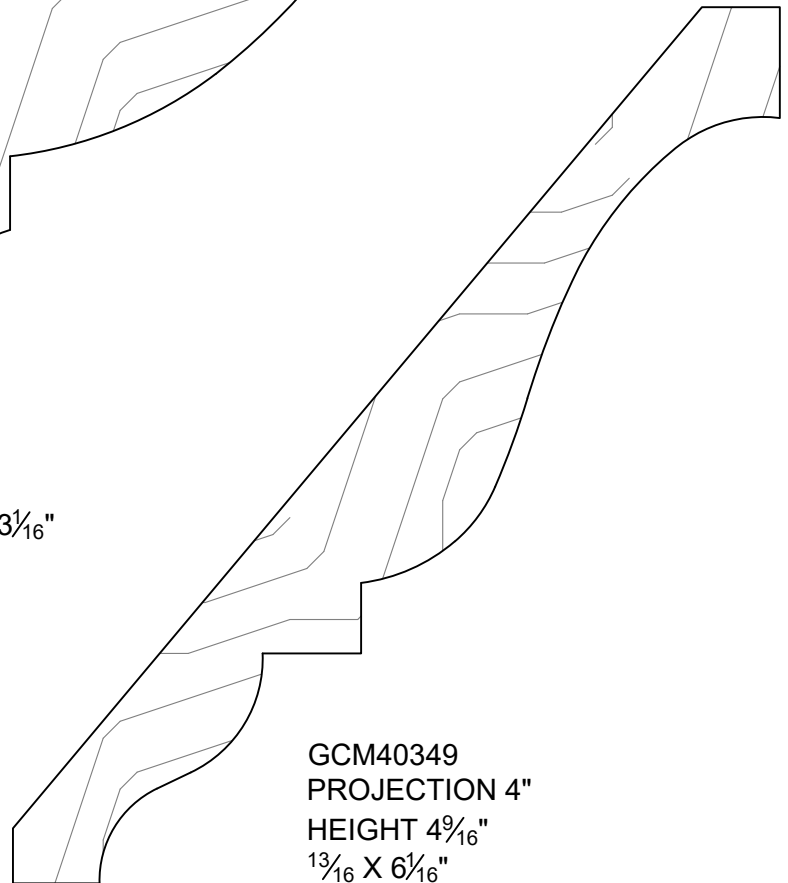

GCM40349  
PROJECTION 4"  
HEIGHT  $4\frac{9}{16}$ "  
 $1\frac{3}{16}$ " X  $6\frac{1}{16}$ "

# GRAYCO BUILDING CENTER

WWW.GRAYCOINC.COM

BLUFFTON  
345 BUCK ISLAND RD, BLUFFTON SC 29910  
(843) 815-5788 FAX 815-5799

LADY'S ISLAND  
20 SAMS POINT WAY, BEAUFORT SC 29907  
(843) 522-9994 FAX 522-9972

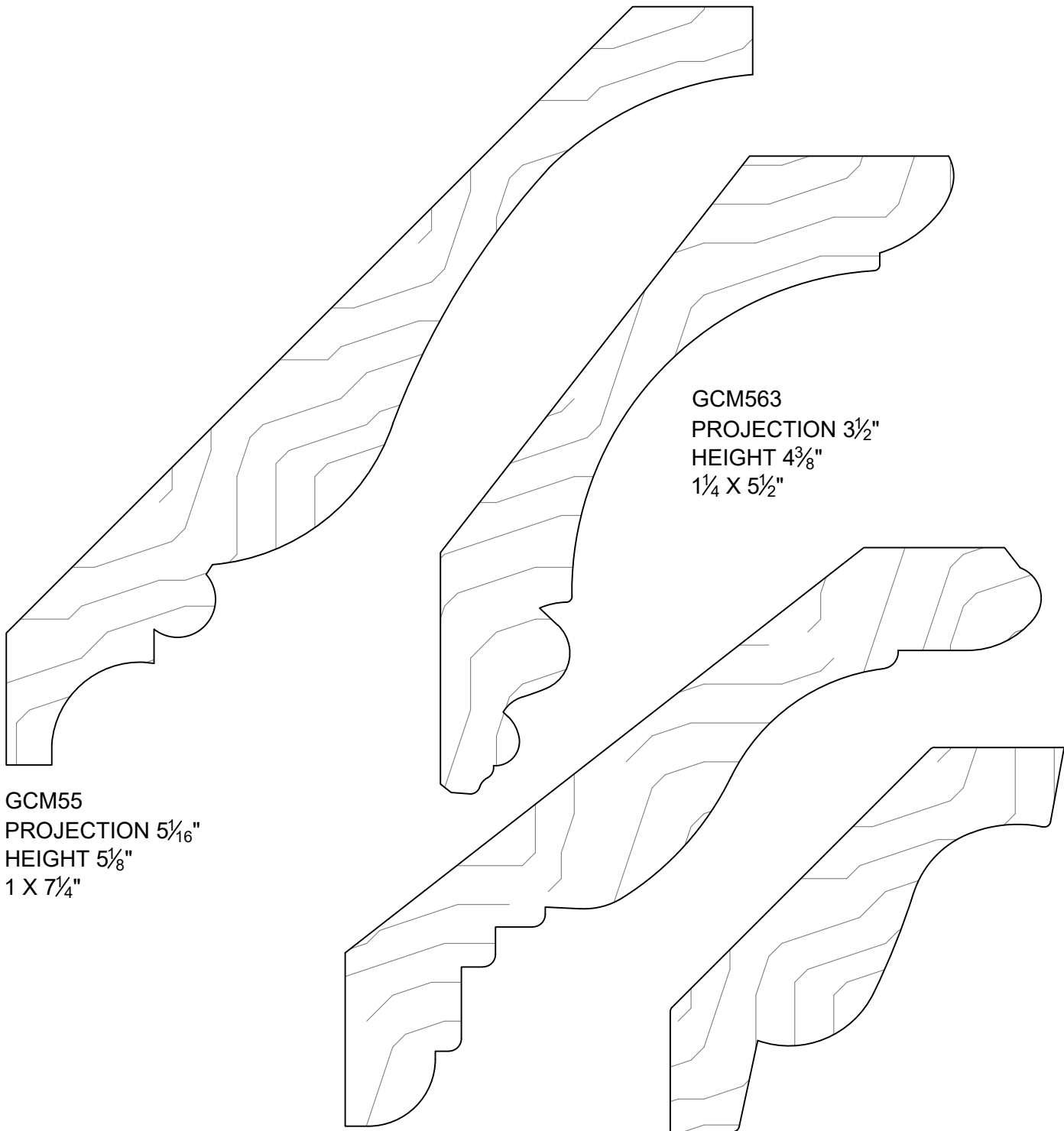

GCM55  
PROJECTION 5<sup>1</sup>/<sub>16</sub>"  
HEIGHT 5<sup>1</sup>/<sub>8</sub>"  
1 X 7<sup>1</sup>/<sub>4</sub>"

GCM563  
PROJECTION 3<sup>1</sup>/<sub>2</sub>"  
HEIGHT 4<sup>3</sup>/<sub>8</sub>"  
1<sup>1</sup>/<sub>4</sub> X 5<sup>1</sup>/<sub>2</sub>"

GCM603  
Projection 4<sup>1</sup>/<sub>16</sub>"  
Height 3<sup>15</sup>/<sub>16</sub>"  
1<sup>1</sup>/<sub>8</sub> X 6

GCM568  
PROJECTION 2<sup>1</sup>/<sub>16</sub>"  
HEIGHT 2<sup>1</sup>/<sub>16</sub>"  
1<sup>5</sup>/<sub>16</sub> X 3<sup>3</sup>/<sub>4</sub>"

# GRAYCO BUILDING CENTER

WWW.GRAYCOINC.COM

BLUFFTON  
345 BUCK ISLAND RD, BLUFFTON SC 29910  
(843) 815-5788 FAX 815-5799

LADY'S ISLAND  
20 SAMS POINT WAY, BEAUFORT SC 29907  
(843) 522-9994 FAX 522-9972

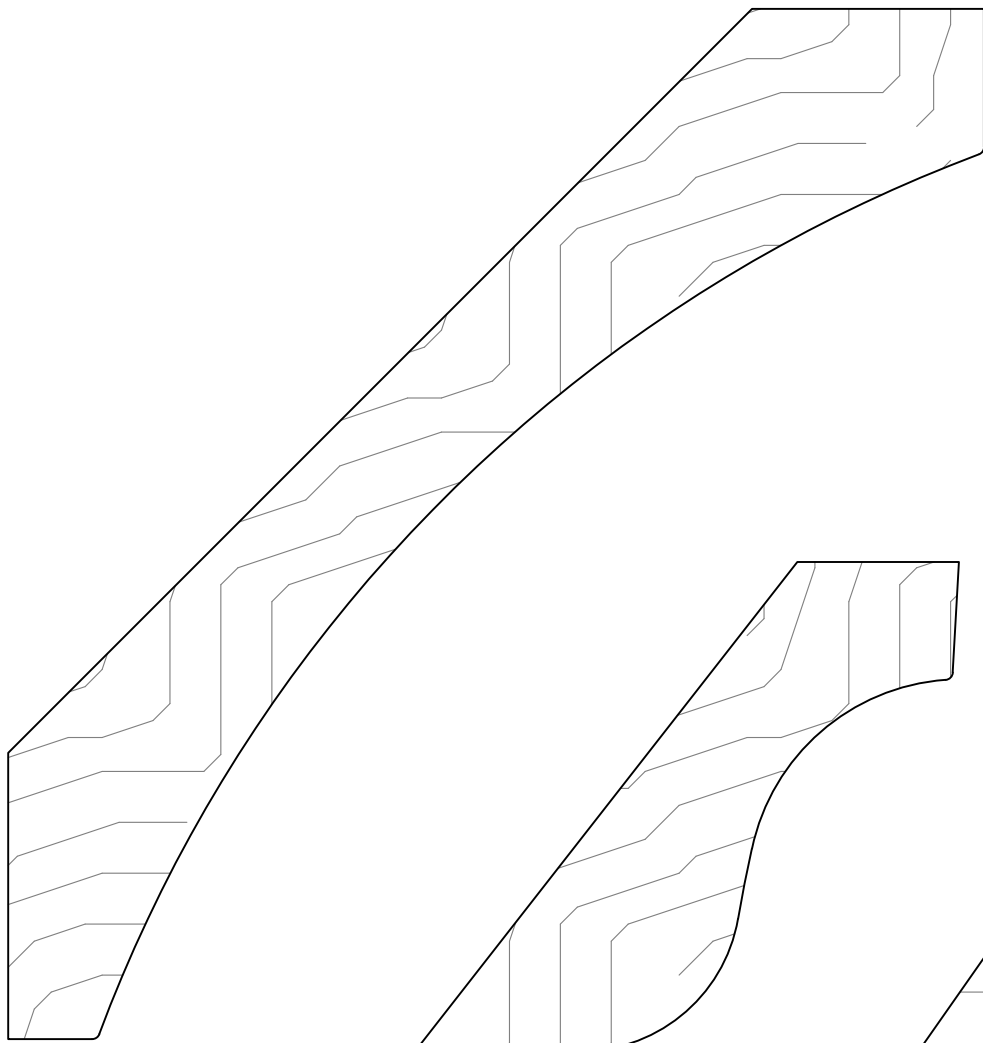

GCM564  
PROJECTION  $5\frac{1}{16}$ "  
HEIGHT  $5\frac{3}{8}$ "  
 $1\frac{3}{8} \times 7\frac{3}{8}$ "

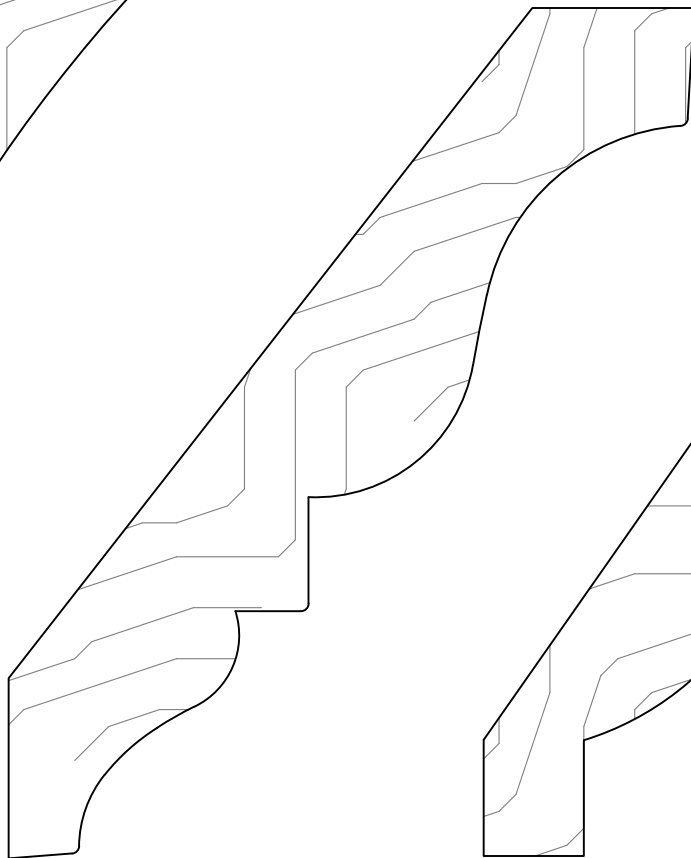

GCM569  
PROJECTION  $3\frac{9}{16}$ "  
HEIGHT  $4\frac{7}{16}$ "  
 $1 \times 5\frac{1}{16}$ "

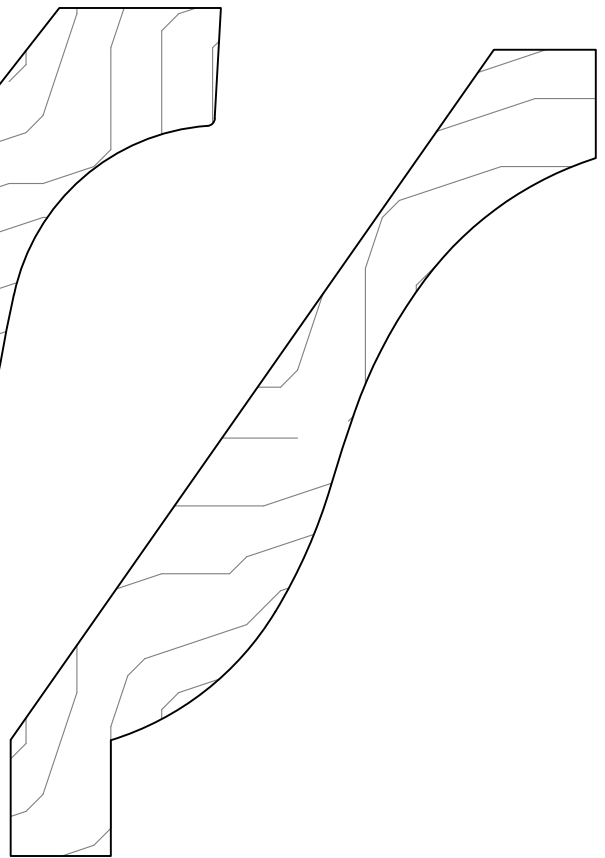

GCM576  
Projection  $3\frac{1}{16}$ "  
Height  $4\frac{3}{16}$ "  
 $\frac{3}{4} \times 5\frac{3}{16}$ "

# GRAYCO BUILDING CENTER

WWW.GRAYCOINC.COM

BLUFFTON  
345 BUCK ISLAND RD, BLUFFTON SC 29910  
(843) 815-5788 FAX 815-5799

LADY'S ISLAND  
20 SAMS POINT WAY, BEAUFORT SC 29907  
(843) 522-9994 FAX 522-9972



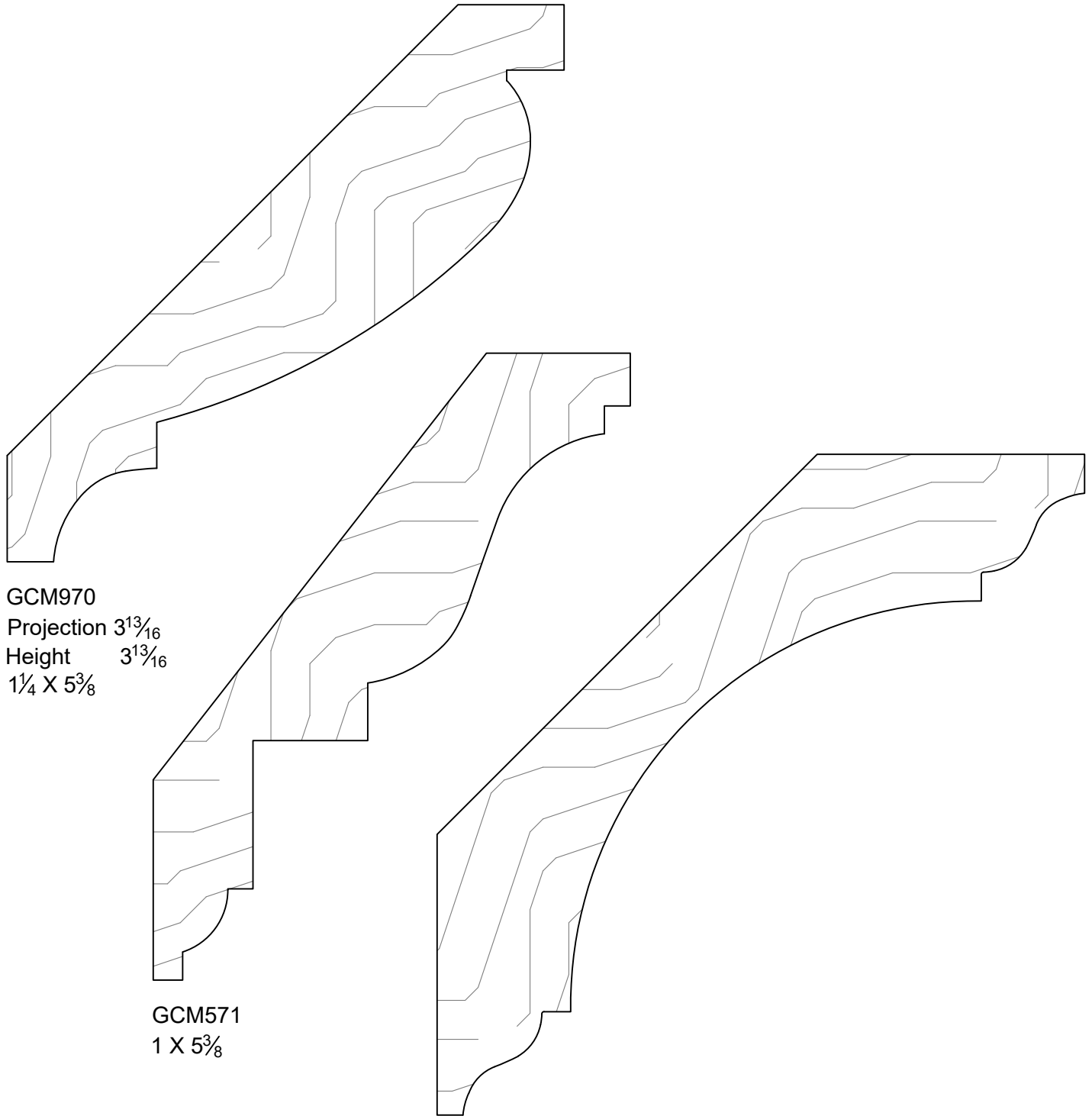

GCM970  
Projection  $3\frac{13}{16}$   
Height  $3\frac{13}{16}$   
 $1\frac{1}{4} \times 5\frac{3}{8}$

GCM571  
 $1 \times 5\frac{3}{8}$

GCM572  
Projection  $4\frac{7}{16}$   
Height  $4\frac{1}{2}$   
 $1\frac{1}{2} \times 6\frac{5}{16}$

# GRAYCO BUILDING CENTER

WWW.GRAYCOINC.COM

BLUFFTON  
345 BUCK ISLAND RD, BLUFFTON SC 29910  
(843) 815-5788 FAX 815-5799

LADY'S ISLAND  
20 SAMS POINT WAY, BEAUFORT SC 29907  
(843) 522-9994 FAX 522-9972

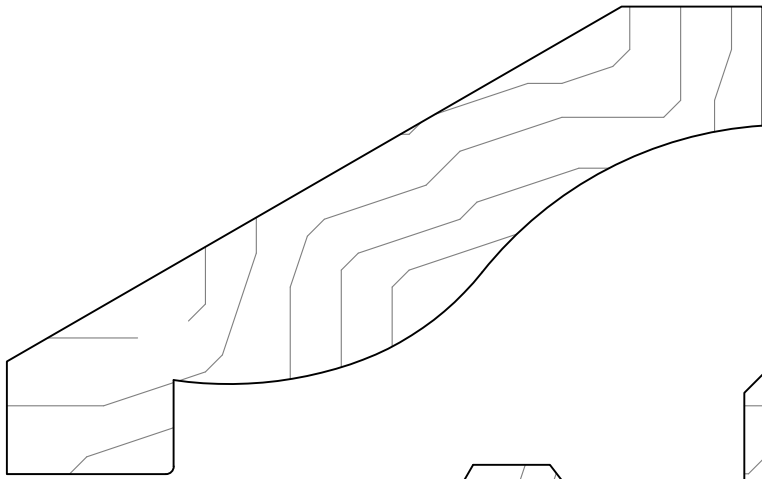

GCM671  
 Projection  $3\frac{15}{16}$   
 Height  $2\frac{7}{16}$   
 $1\frac{15}{16}$  X  $4\frac{5}{8}$



GCM579  
 Projection  $3\frac{3}{16}$   
 Height  $3\frac{5}{16}$   
 1 X  $4\frac{5}{8}$

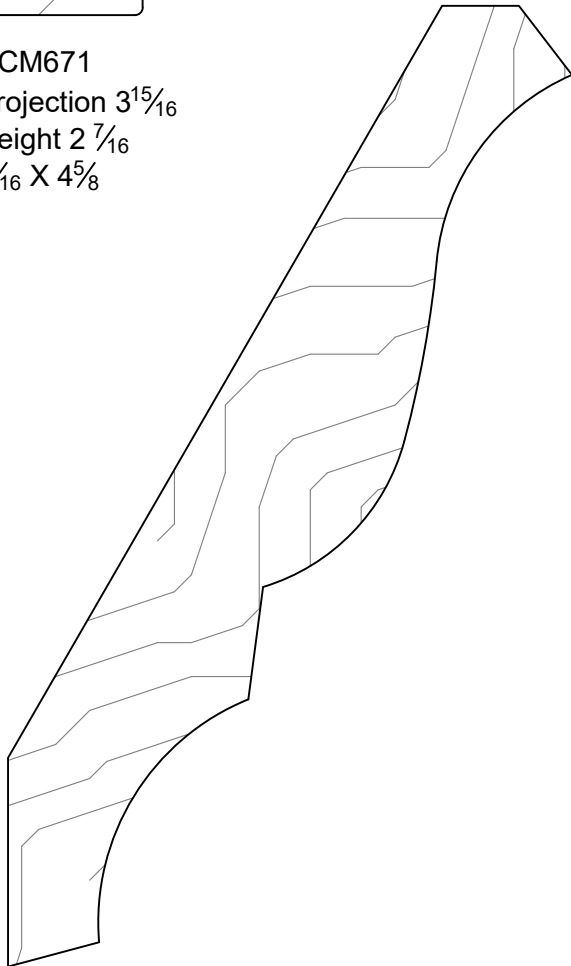

GCM577  
 Projection  $2\frac{1}{16}$   
 Height 5  
 1 X  $5\frac{5}{8}$

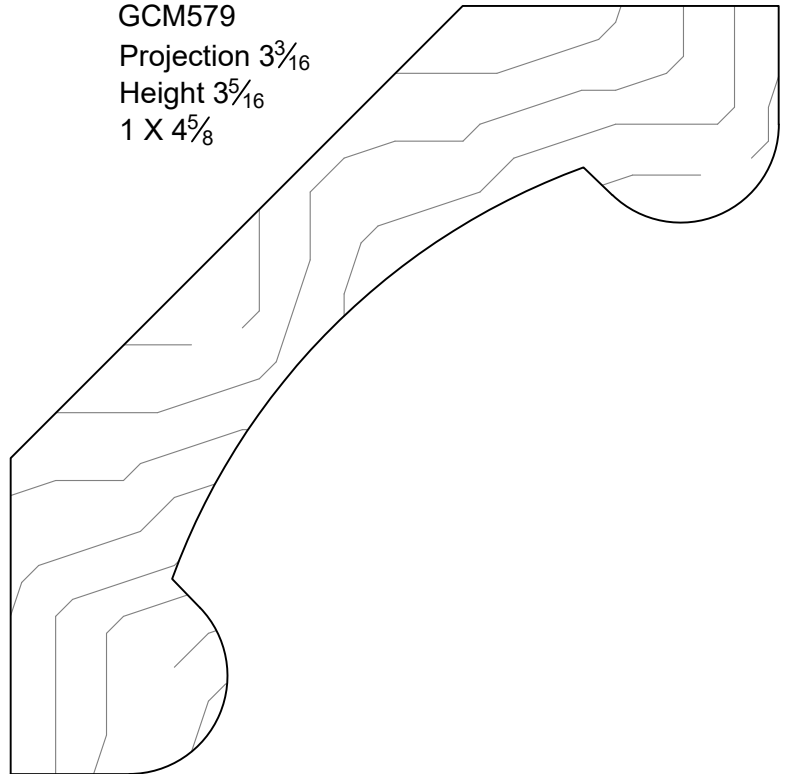

GCM582  
 Projection 4  
 Height 4  
 $1\frac{3}{4}$  X  $5\frac{1}{16}$

# GRAYCO BUILDING CENTER

WWW.GRAYCOINC.COM

BLUFFTON  
 345 BUCK ISLAND RD, BLUFFTON SC 29910  
 (843) 815-5788 FAX 815-5799

LADY'S ISLAND  
 20 SAMS POINT WAY, BEAUFORT SC 29907  
 (843) 522-9994 FAX 522-9972

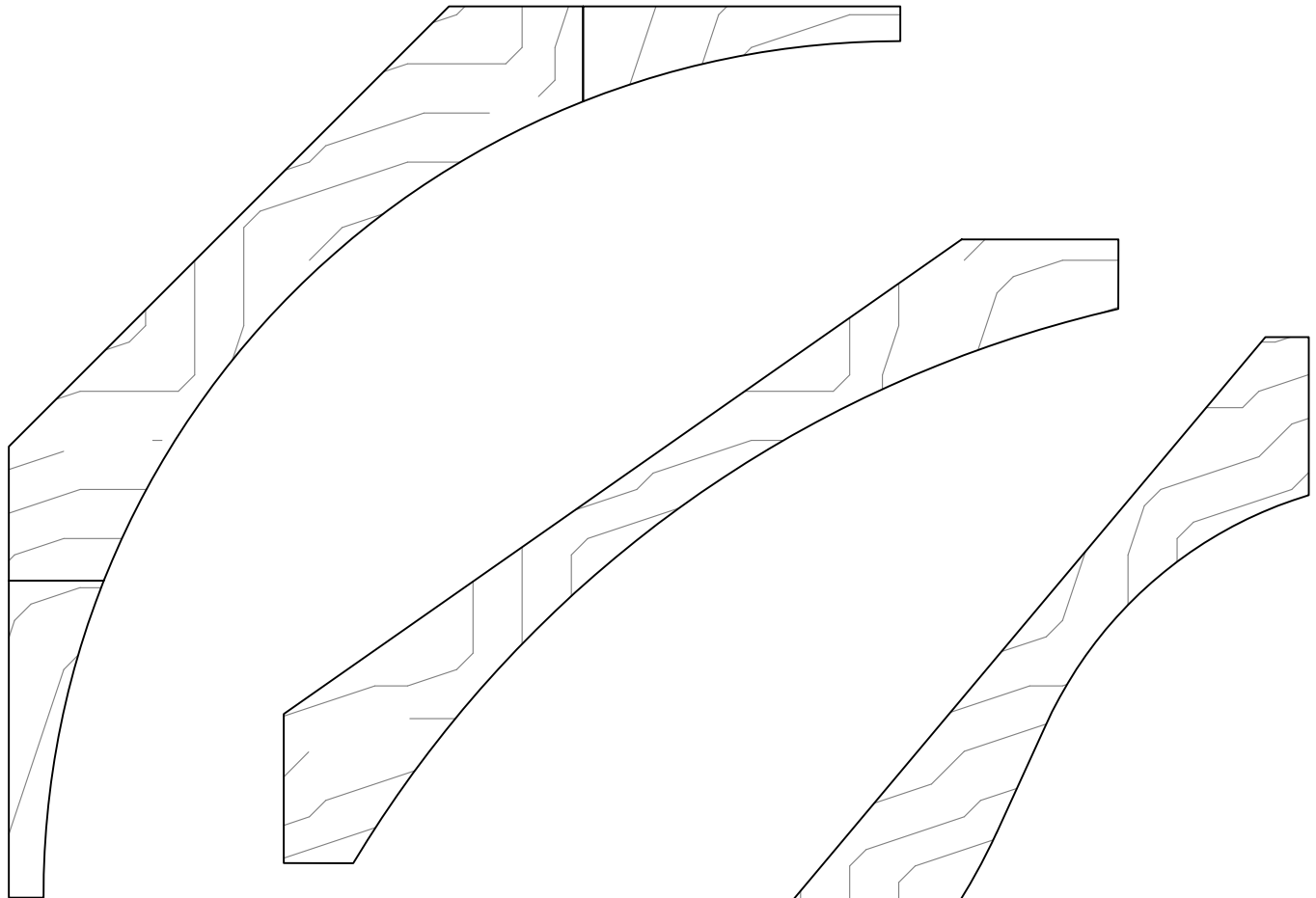

GCM580  
 Projection  $9\frac{5}{8}$   
 Height  $9\frac{5}{8}$   
 1 @  $1\frac{3}{4}$  X  $8\frac{13}{16}$   
 2 @ 1 X  $3\frac{1}{2}$

GCM1108B  
 Projection 9  
 Height  $6\frac{3}{4}$   
 $1\frac{3}{4}$  X  $11\frac{1}{4}$

GCM412  
 PROJECTION  $4\frac{5}{16}$ "  
 HEIGHT  $5\frac{1}{2}$ "  
 $\frac{3}{4}$  X 7"

# GRAYCO BUILDING CENTER

WWW.GRAYCOINC.COM

BLUFFTON  
 345 BUCK ISLAND RD, BLUFFTON SC 29910  
 (843) 815-5788 FAX 815-5799

LADY'S ISLAND  
 20 SAMS POINT WAY, BEAUFORT SC 29907  
 (843) 522-9994 FAX 522-9972

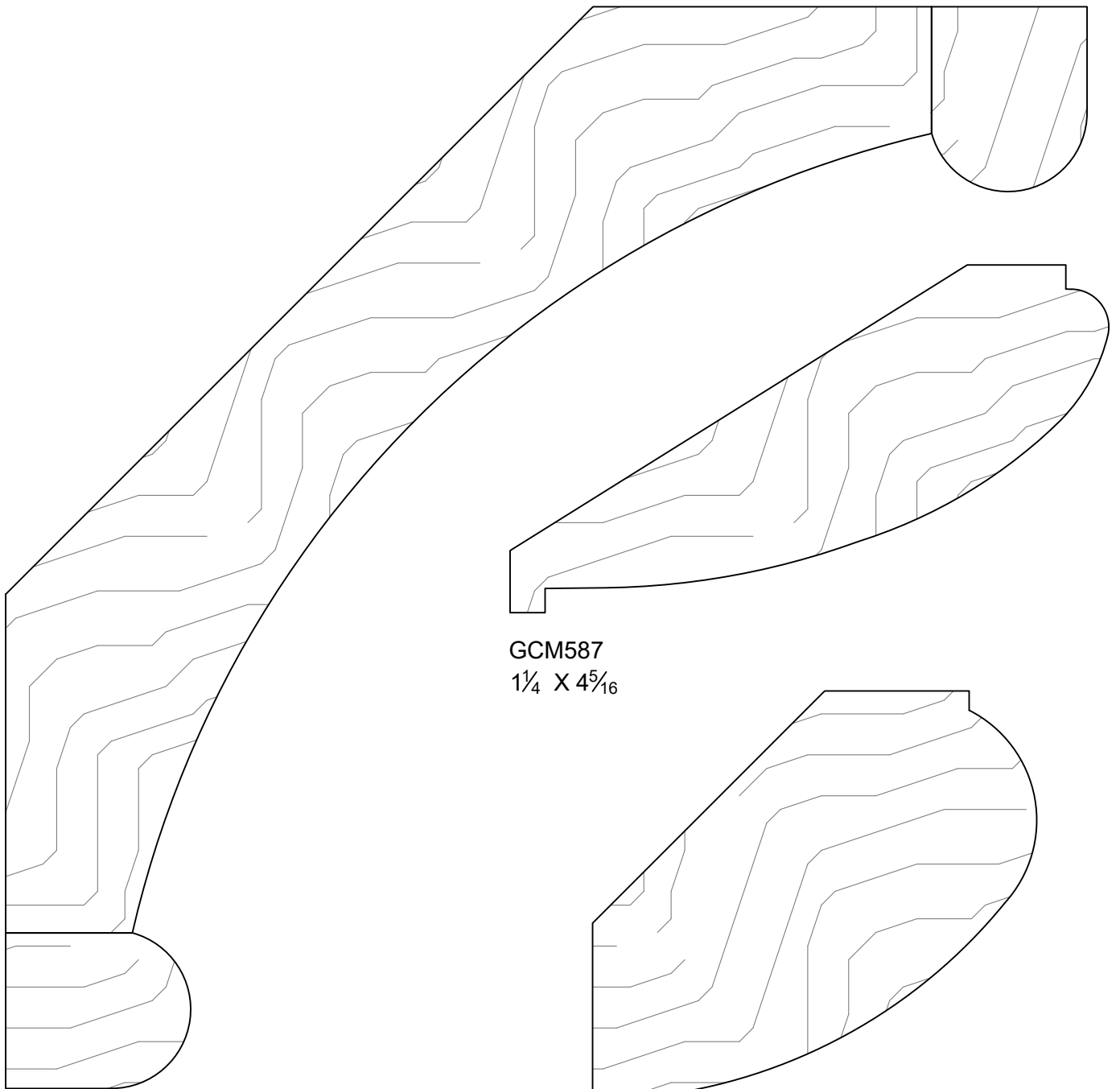

GCM587  
1¼ X 4<sup>5</sup>/<sub>16</sub>

GCM581  
Projection 7  
Height 7  
1 @ 1¾ X 8½  
2 @ 1 X 1¼

GCM1246  
Projection 2<sup>7</sup>/<sub>8</sub>  
Height 3<sup>5</sup>/<sub>8</sub>  
1¾ x 4<sup>3</sup>/<sub>8</sub>

# GRAYCO BUILDING CENTER

WWW.GRAYCOINC.COM

BLUFFTON  
345 BUCK ISLAND RD, BLUFFTON SC 29910  
(843) 815-5788 FAX 815-5799

LADY'S ISLAND  
20 SAMS POINT WAY, BEAUFORT SC 29907  
(843) 522-9994 FAX 522-9972

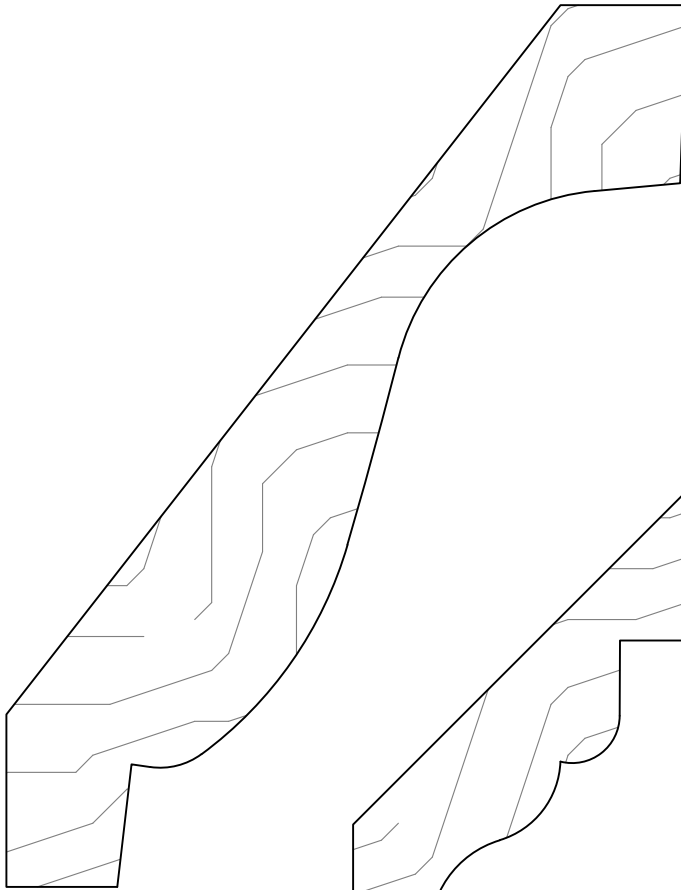

GCM633  
Projection  $3 \frac{9}{16}$   
Height  $4 \frac{9}{16}$   
 $1 \frac{1}{16} \times 5 \frac{13}{16}$

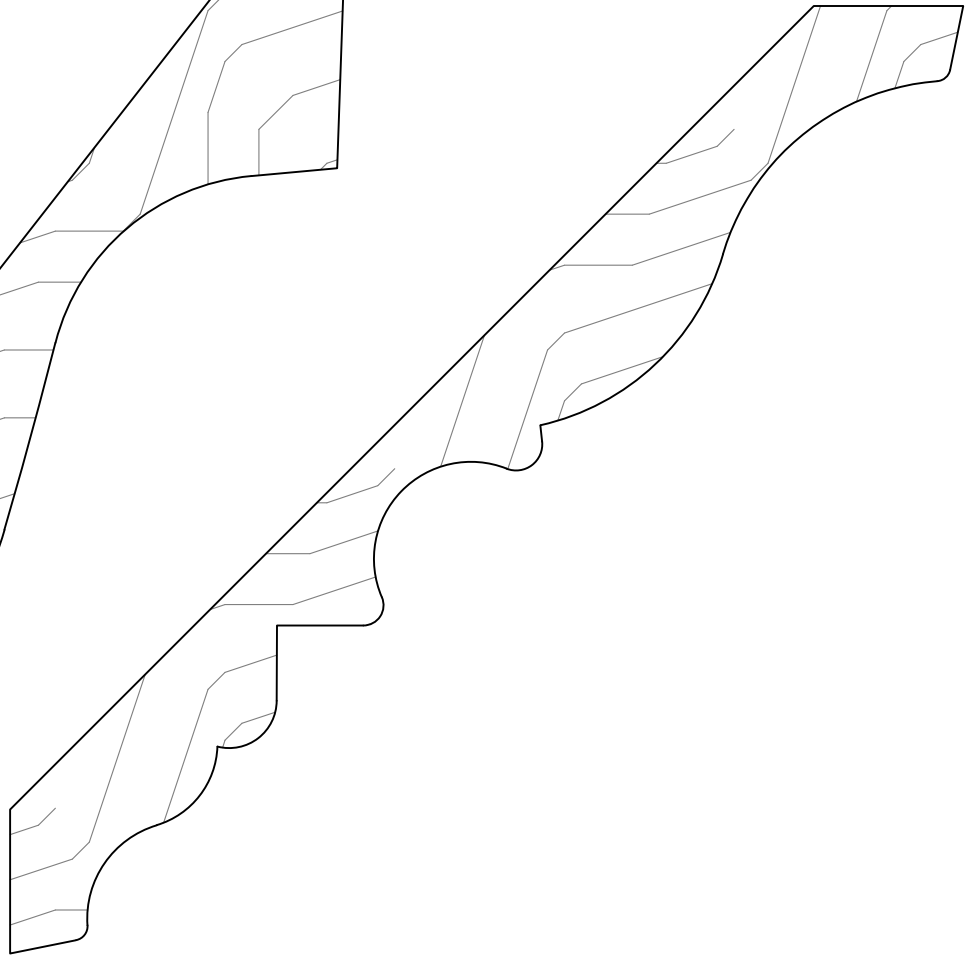

GCM634  
Projection  $4 \frac{15}{16}$   
Height  $4 \frac{15}{16}$   
 $\frac{3}{4} \times 7$

# GRAYCO BUILDING CENTER

[WWW.GRAYCOINC.COM](http://WWW.GRAYCOINC.COM)

BLUFFTON  
345 BUCK ISLAND RD, BLUFFTON SC 29910  
(843) 815-5788 FAX 815-5799

LADY'S ISLAND  
20 SAMS POINT WAY, BEAUFORT SC 29907  
(843) 522-9994 FAX 522-9972

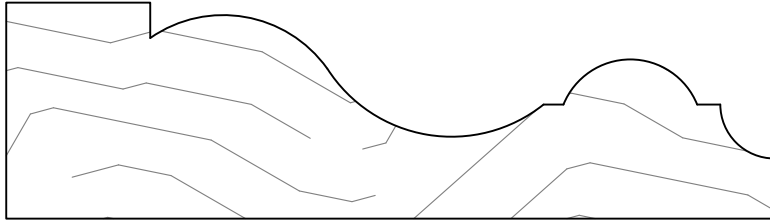

GCM60967  
1 1/8 X 4

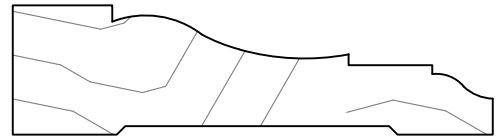

GCM361  
1 1/16 X 2 1/2

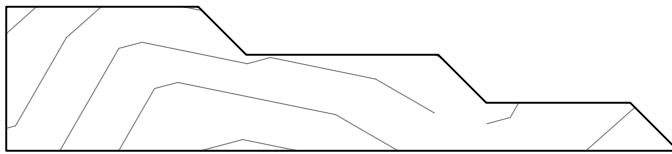

GCM1027  
3/4 X 3 1/2"

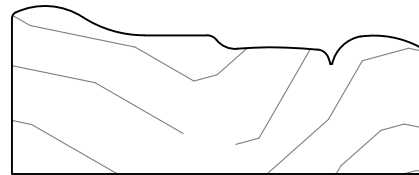

GCM1152  
7/8 X 2 1/8

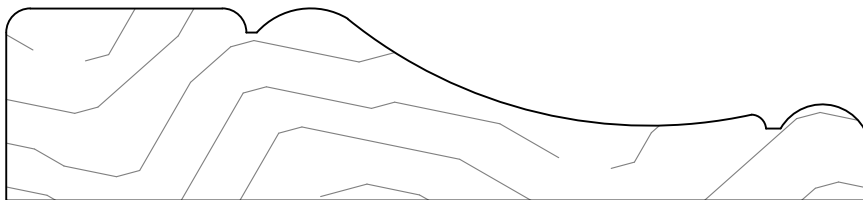

GCM1290  
1 X 4 1/2

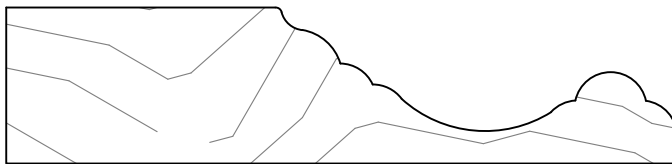

GCM3.5 APRON  
1 3/16 X 3 1/2

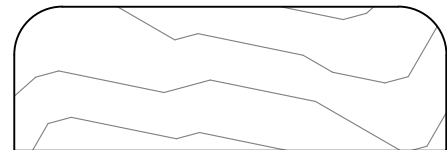

GCM452  
3/4 X 2 1/4

# GRAYCO BUILDING CENTER

WWW.GRAYCOINC.COM

BLUFFTON  
345 BUCK ISLAND RD, BLUFFTON SC 29910  
(843) 815-5788 FAX 815-5799

LADY'S ISLAND  
20 SAMS POINT WAY, BEAUFORT SC 29907  
(843) 522-9994 FAX 522-9972

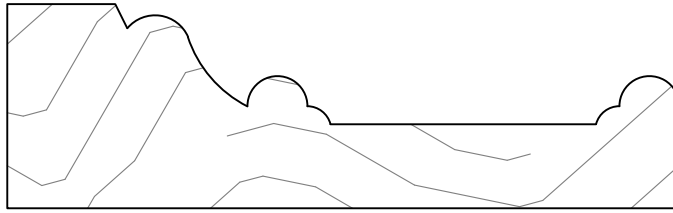

GCM3  
1 $\frac{1}{16}$  X 3 $\frac{1}{2}$

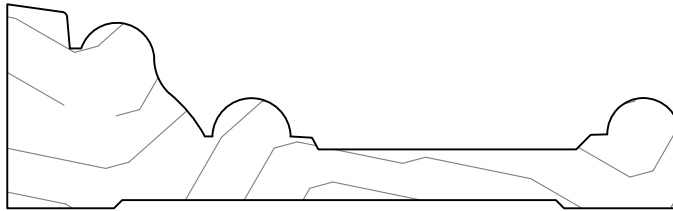

GCM1003  
1 $\frac{1}{16}$  X 3 $\frac{1}{2}$

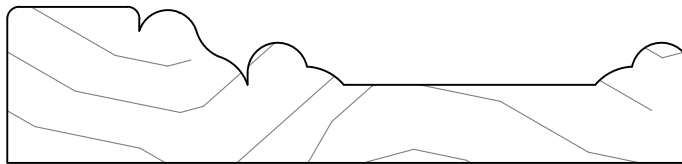

GCM40545  
1 $\frac{3}{16}$  X 3 $\frac{9}{16}$

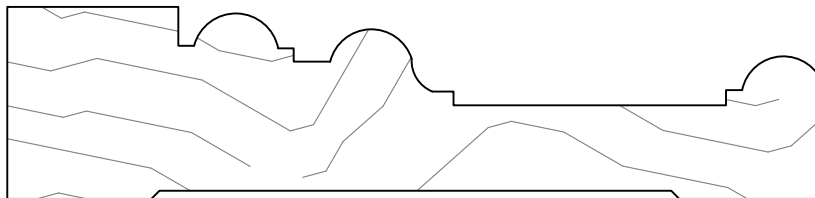

GCM475  
1 X 4 $\frac{1}{4}$

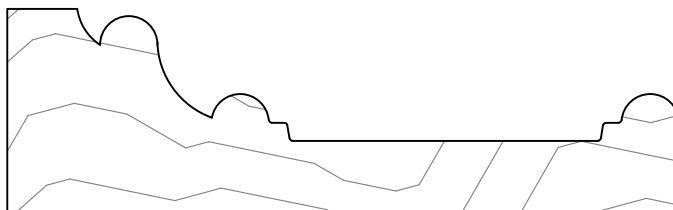

GCM1017  
1 $\frac{1}{16}$  X 3 $\frac{1}{2}$

# GRAYCO BUILDING CENTER

WWW.GRAYCOINC.COM

BLUFFTON  
345 BUCK ISLAND RD, BLUFFTON SC 29910  
(843) 815-5788 FAX 815-5799

LADY'S ISLAND  
20 SAMS POINT WAY, BEAUFORT SC 29907  
(843) 522-9994 FAX 522-9972

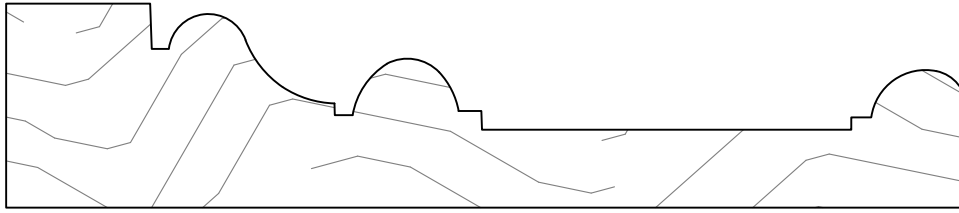

GCM1023  
1 1/16 x 5

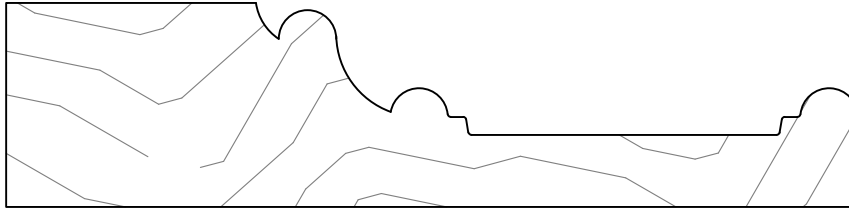

GCM1017B  
1 1/16 x 4 7/16



GCM414M  
1 1/16 x 3 9/16



GCM1913  
1 1/4 x 5

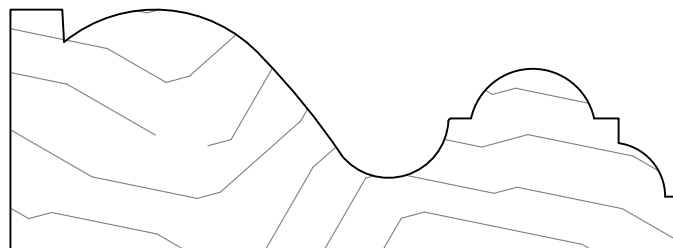

GCM1912  
1 1/4 x 3 1/2

# GRAYCO BUILDING CENTER

WWW.GRAYCOINC.COM

BLUFFTON  
345 BUCK ISLAND RD, BLUFFTON SC 29910  
(843) 815-5788 FAX 815-5799

LADY'S ISLAND  
20 SAMS POINT WAY, BEAUFORT SC 29907  
(843) 522-9994 FAX 522-9972



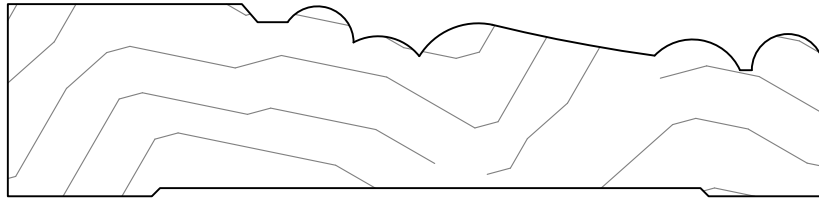

GCM826  
1 X 4¼

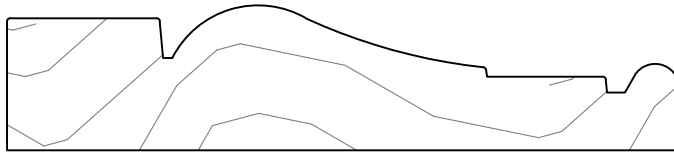

GCM44145  
1½ X 3½

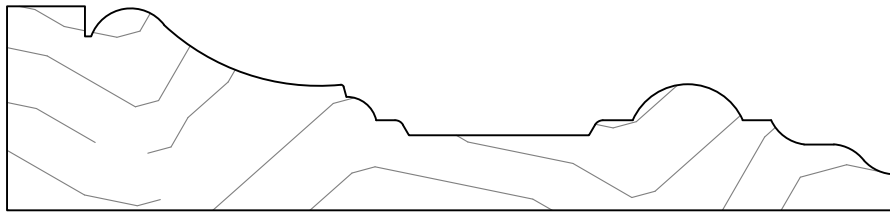

GCM466  
1½ X 4⅝

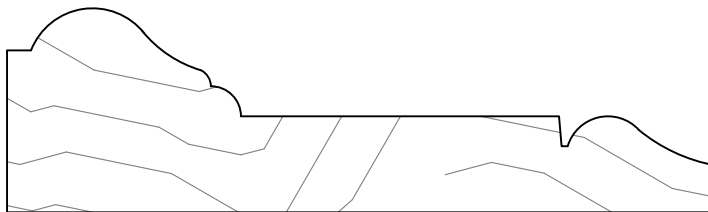

GCM460  
1½ X 3¼

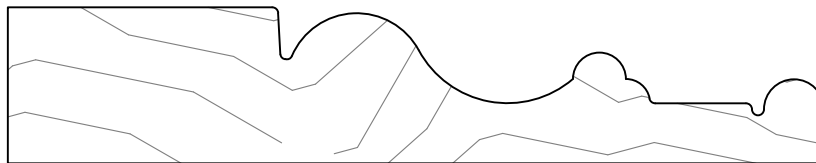

GCM40530  
1¾ X 4¼

# GRAYCO BUILDING CENTER

WWW.GRAYCOINC.COM

BLUFFTON  
345 BUCK ISLAND RD, BLUFFTON SC 29910  
(843) 815-5788 FAX 815-5799

LADY'S ISLAND  
20 SAMS POINT WAY, BEAUFORT SC 29907  
(843) 522-9994 FAX 522-9972

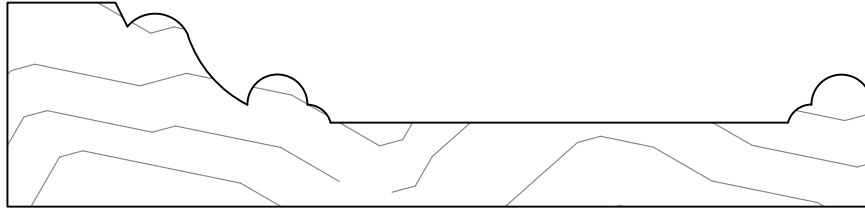

GCM3.1  
 $1\frac{1}{16} \times 4\frac{1}{2}$

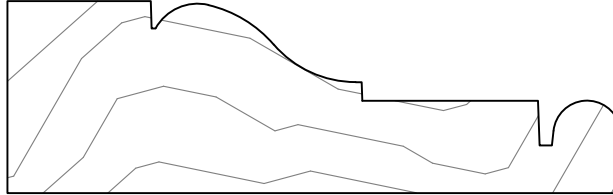

GCM1163  
 $1 \times 3\frac{3}{16}$

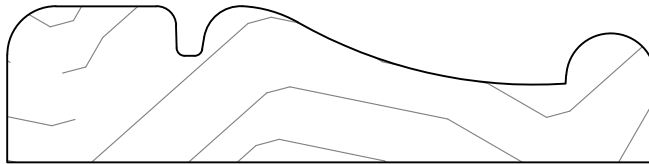

GCM1164  
 $1\frac{3}{16} \times 3\frac{3}{8}$ "

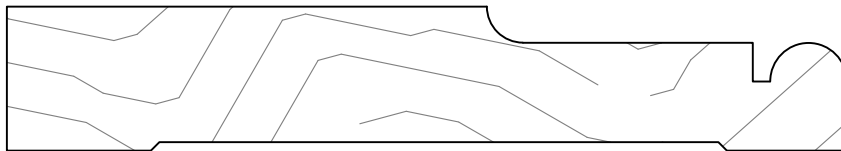

GCM1360  
 $\frac{3}{4} \times 4\frac{3}{8}$



GCM1169  
 $1\frac{1}{16} \times 3\frac{1}{4}$

# GRAYCO BUILDING CENTER

WWW.GRAYCOINC.COM

BLUFFTON  
345 BUCK ISLAND RD, BLUFFTON SC 29910  
(843) 815-5788 FAX 815-5799

LADY'S ISLAND  
20 SAMS POINT WAY, BEAUFORT SC 29907  
(843) 522-9994 FAX 522-9972

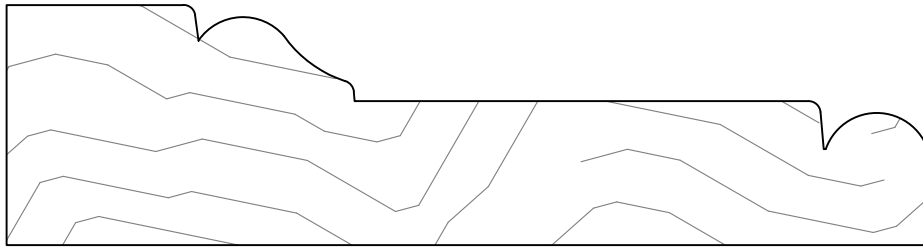

GCM60425  
 $1\frac{1}{4} \times 4\frac{13}{16}$

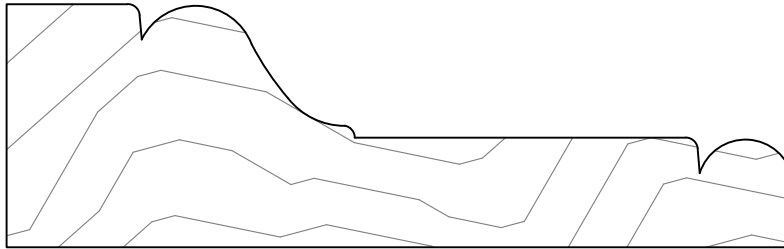

GCM60468  
 $1\frac{1}{4} \times 4\frac{1}{8}$



GCM444  
 $1\frac{1}{16} \times 3\frac{1}{2}$

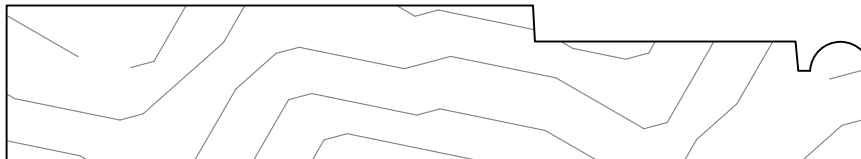

GCM1194  
 $1\frac{3}{16} \times 4\frac{1}{2}$



GCM1160  
 $1\frac{1}{16} \times 4\frac{3}{4}$

# GRAYCO BUILDING CENTER

WWW.GRAYCOINC.COM

BLUFFTON  
345 BUCK ISLAND RD, BLUFFTON SC 29910  
(843) 815-5788 FAX 815-5799

LADY'S ISLAND  
20 SAMS POINT WAY, BEAUFORT SC 29907  
(843) 522-9994 FAX 522-9972

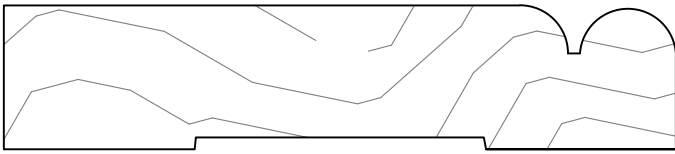

GCM4006  
3/4 X 3 1/2

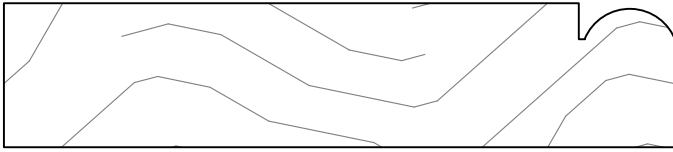

GCM218  
3/4 X 3 1/2

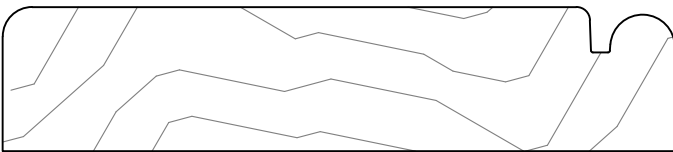

GCM1156  
3/4 X 3 1/2

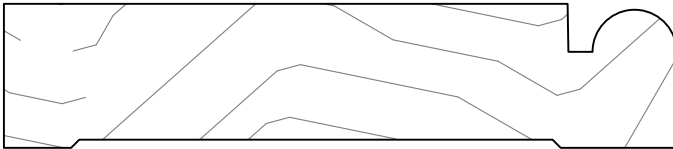

GCM585  
3/4 X VARIES



GCM4007  
3/4 X 3 1/2

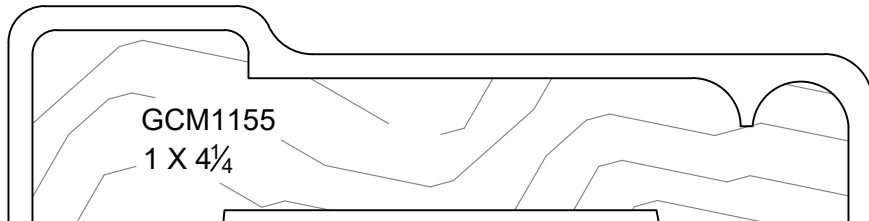

GCM1155  
1 X 4 1/4

GCM1154  
1 1/8 X 4 1/2

# GRAYCO BUILDING CENTER

WWW.GRAYCOINC.COM

BLUFFTON  
345 BUCK ISLAND RD, BLUFFTON SC 29910  
(843) 815-5788 FAX 815-5799

LADY'S ISLAND  
20 SAMS POINT WAY, BEAUFORT SC 29907  
(843) 522-9994 FAX 522-9972

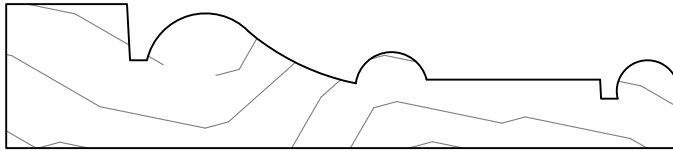

GCM40350

$\frac{3}{4} \times 3\frac{1}{2}$

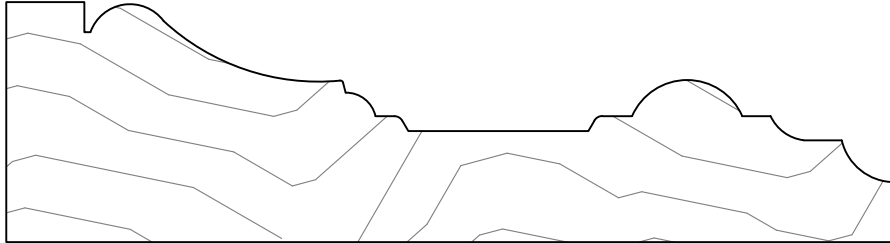

GCM64466

$1\frac{1}{4} \times 4\frac{5}{8}$

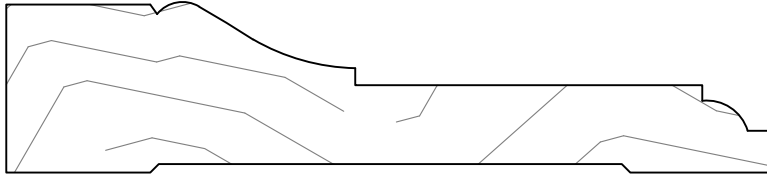

GCM422

$\frac{7}{8} \times 4$

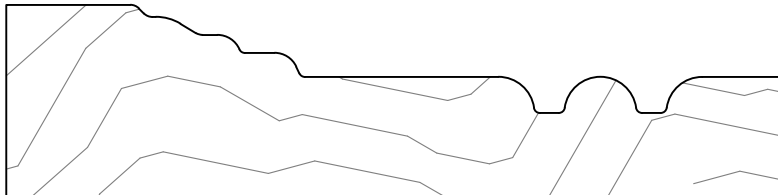

GCM5406

$1 \times 4\frac{1}{16}$

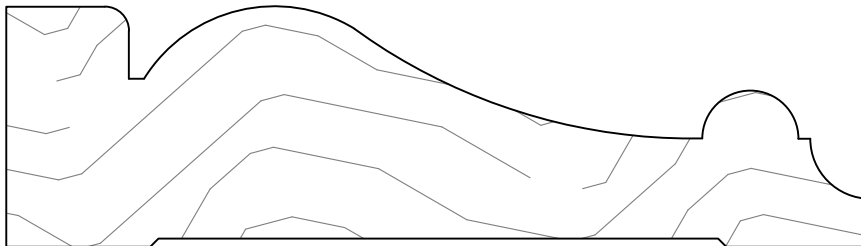

GCM787M

$1\frac{1}{4} \times 4\frac{1}{2}$

# GRAYCO BUILDING CENTER

[WWW.GRAYCOINC.COM](http://WWW.GRAYCOINC.COM)

BLUFFTON  
345 BUCK ISLAND RD, BLUFFTON SC 29910  
(843) 815-5788 FAX 815-5799

LADY'S ISLAND  
20 SAMS POINT WAY, BEAUFORT SC 29907  
(843) 522-9994 FAX 522-9972

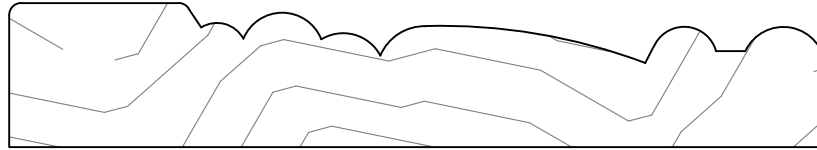

GCM4257  
3/4 x 4 1/4

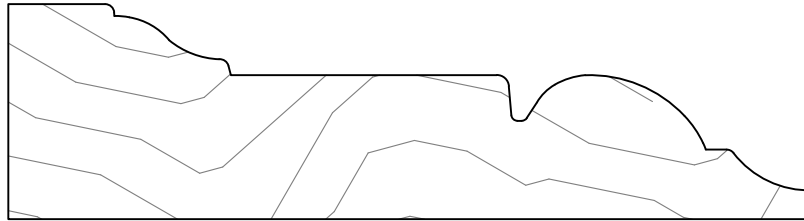

GCM6441  
1 1/8 x 4 3/16

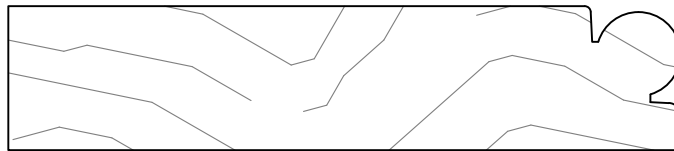

GCM44305  
3/4 x VARIES

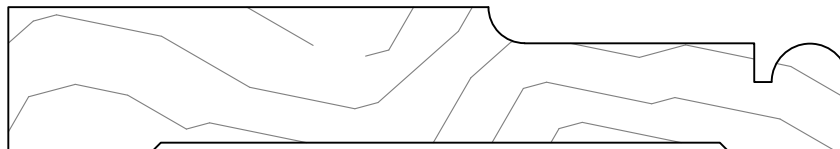

GCM1360  
3/4 x 4 3/8

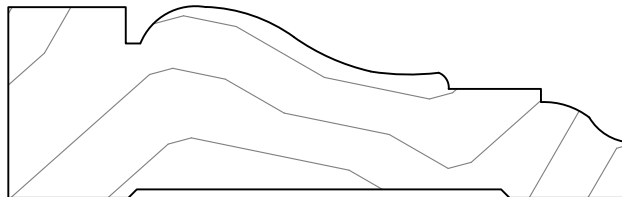

GCM4552  
1 X 3 1/4

# GRAYCO BUILDING CENTER

WWW.GRAYCOINC.COM

BLUFFTON  
345 BUCK ISLAND RD, BLUFFTON SC 29910  
(843) 815-5788 FAX 815-5799

LADY'S ISLAND  
20 SAMS POINT WAY, BEAUFORT SC 29907  
(843) 522-9994 FAX 522-9972

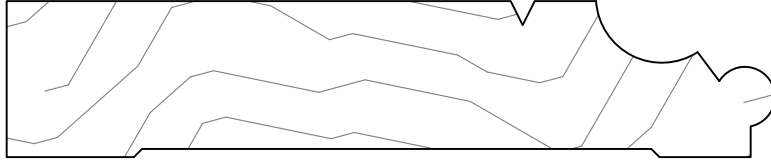

GCM769  
 $1\frac{3}{16} \times 4$

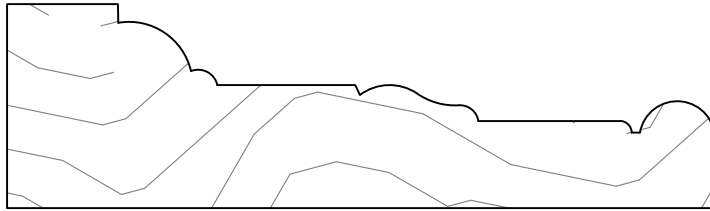

GCM470  
 $1\frac{1}{16} \times 3\frac{1}{16}$

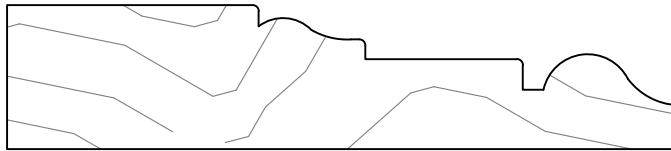

GCM1004  
 $\frac{3}{4} \times 3\frac{1}{2}$

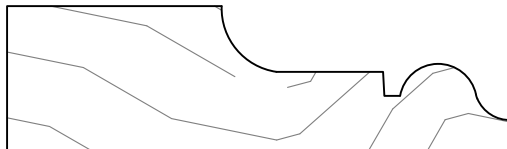

GCM1008  
 $\frac{3}{4} \times 2\frac{5}{8}$

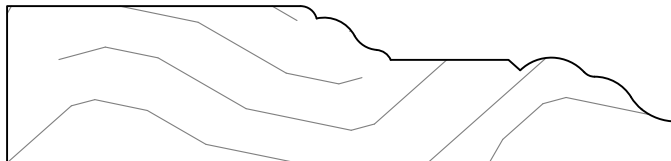

GCM1009  
 $1\frac{3}{16} \times 3\frac{1}{2}$

# GRAYCO BUILDING CENTER

WWW.GRAYCOINC.COM

BLUFFTON  
345 BUCK ISLAND RD, BLUFFTON SC 29910  
(843) 815-5788 FAX 815-5799

LADY'S ISLAND  
20 SAMS POINT WAY, BEAUFORT SC 29907  
(843) 522-9994 FAX 522-9972

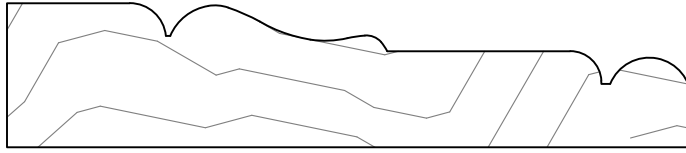

GCM1013  
 $\frac{3}{4} \times 3\frac{9}{16}$

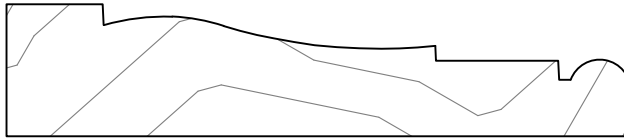

GCM445  
 $1\frac{1}{16} \times 3\frac{1}{4}$

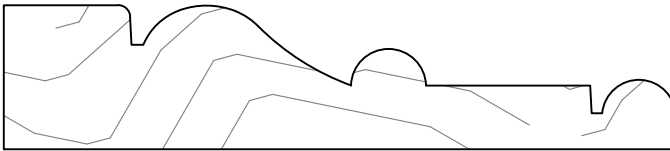

GCM1015  
 $\frac{3}{4} \times 3\frac{1}{2}$

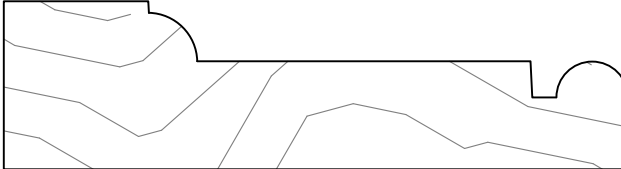

GCM597B  
 $\frac{7}{8} \times 3\frac{1}{4}$



GCM1005  
 $\frac{3}{4} \times 4\frac{1}{2}$

# GRAYCO BUILDING CENTER

WWW.GRAYCOINC.COM

BLUFFTON  
345 BUCK ISLAND RD, BLUFFTON SC 29910  
(843) 815-5788 FAX 815-5799

LADY'S ISLAND  
20 SAMS POINT WAY, BEAUFORT SC 29907  
(843) 522-9994 FAX 522-9972



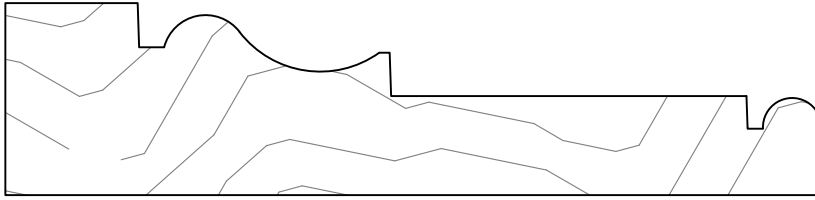

GCM1032  
1 X 4¼"

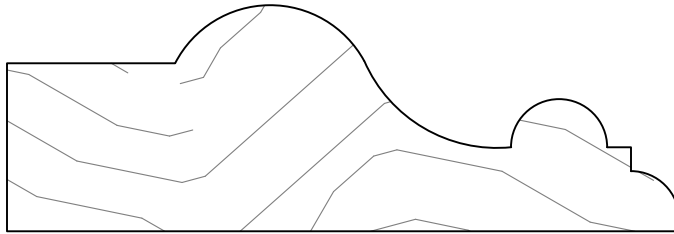

GCM1002  
1¾ X 3½

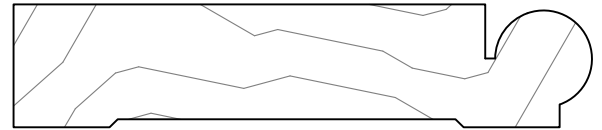

GCM793  
¾ X VARIES

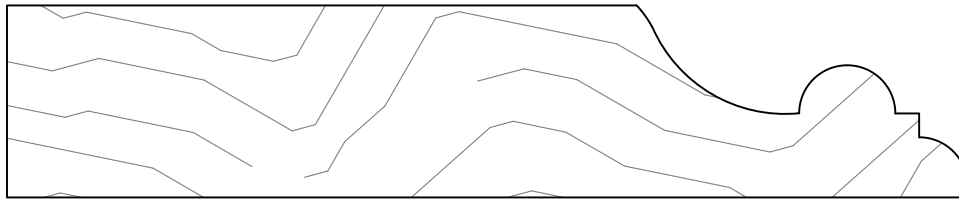

GCM1012  
1 X 5

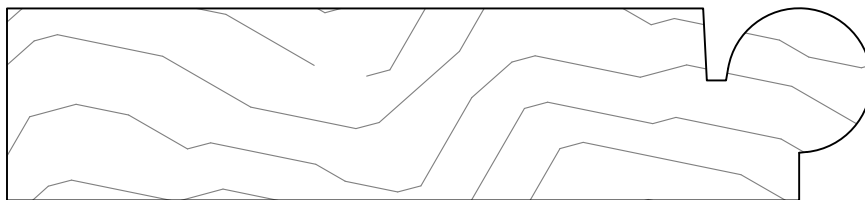

GCM1006  
1 x 4½



GCM1033  
1¾ x 4¼"

# GRAYCO BUILDING CENTER

WWW.GRAYCOINC.COM

BLUFFTON  
345 BUCK ISLAND RD, BLUFFTON SC 29910  
(843) 815-5788 FAX 815-5799

LADY'S ISLAND  
20 SAMS POINT WAY, BEAUFORT SC 29907  
(843) 522-9994 FAX 522-9972



GCM117

$\frac{3}{4} \times 2\frac{3}{4}$

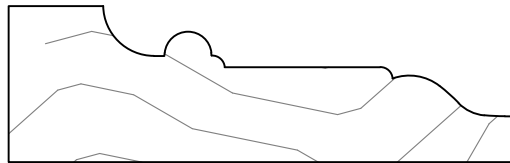

GCM1020

$1\frac{3}{16} \times 2\frac{5}{8}$

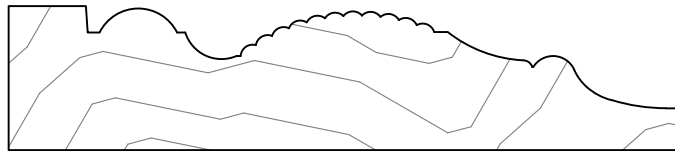

GCM1019

$\frac{3}{4} \times 3\frac{1}{2}$

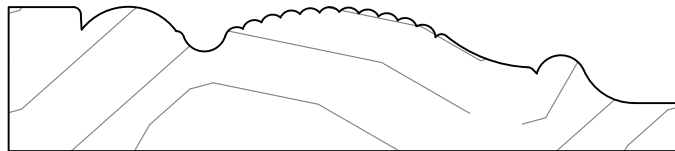

GCM1037

$\frac{3}{4} \times 3\frac{1}{2}$

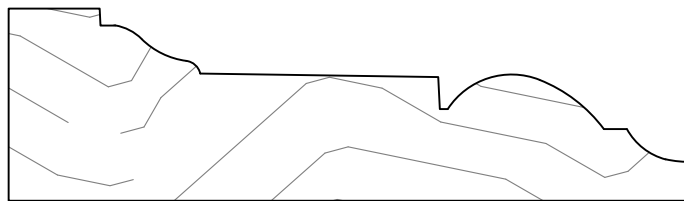

GCM1026

$1 \times 3\frac{5}{16}$

# GRAYCO BUILDING CENTER

[WWW.GRAYCOINC.COM](http://WWW.GRAYCOINC.COM)

BLUFFTON  
345 BUCK ISLAND RD, BLUFFTON SC 29910  
(843) 815-5788 FAX 815-5799

LADY'S ISLAND  
20 SAMS POINT WAY, BEAUFORT SC 29907  
(843) 522-9994 FAX 522-9972

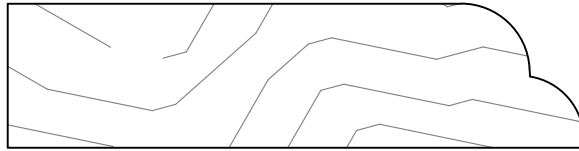

GCM455  
 $\frac{3}{4} \times 3"$



GCM1177  
 $\frac{1}{2} \times 2\frac{7}{8}$

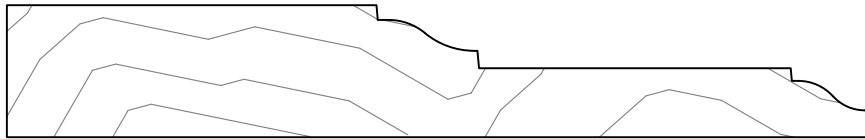

GCM8846  
 $1\frac{1}{16} \times 4\frac{1}{2}$

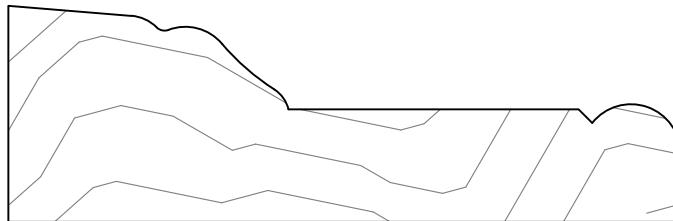

GCM1179  
 $1\frac{1}{8} \times 3\frac{1}{2}$

# GRAYCO BUILDING CENTER

WWW.GRAYCOINC.COM

BLUFFTON  
345 BUCK ISLAND RD, BLUFFTON SC 29910  
(843) 815-5788 FAX 815-5799

LADY'S ISLAND  
20 SAMS POINT WAY, BEAUFORT SC 29907  
(843) 522-9994 FAX 522-9972

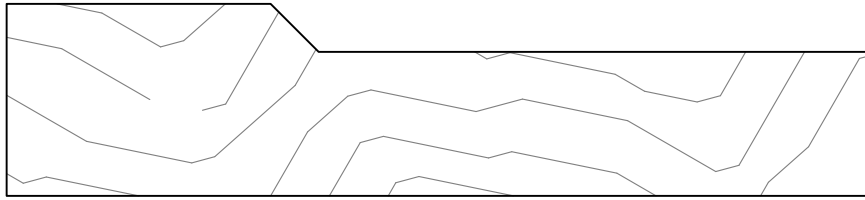

GCM1161  
1 X 4½

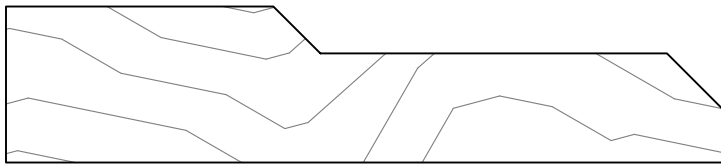

GCM1171  
1¾ X 3¾

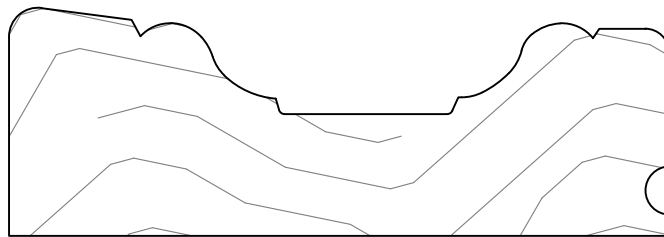

GCM1018  
1¾ X 3¾

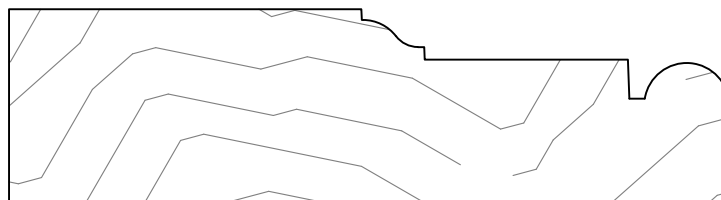

GCM1170 (NEW)  
1 X 3¾

# GRAYCO BUILDING CENTER

WWW.GRAYCOINC.COM

BLUFFTON  
345 BUCK ISLAND RD, BLUFFTON SC 29910  
(843) 815-5788 FAX 815-5799

LADY'S ISLAND  
20 SAMS POINT WAY, BEAUFORT SC 29907  
(843) 522-9994 FAX 522-9972

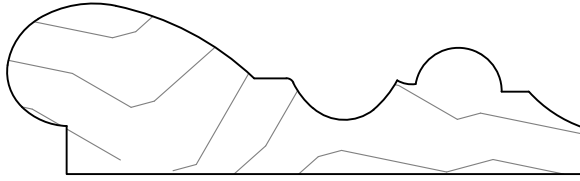

GCM9025

$\frac{7}{8} \times 3$

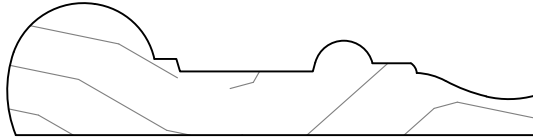

GCM1024

$1\frac{1}{16} \times 2\frac{3}{4}$

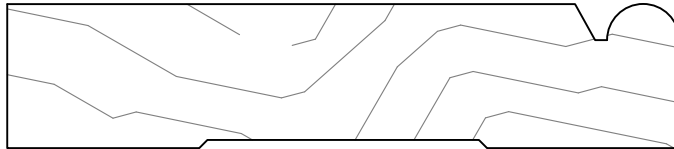

GCM1759

$\frac{3}{4} \times 3\frac{1}{2}$

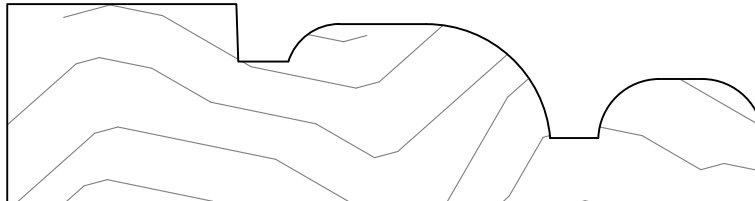

GCM1025

$1\frac{1}{32} \times 3\frac{15}{16}$

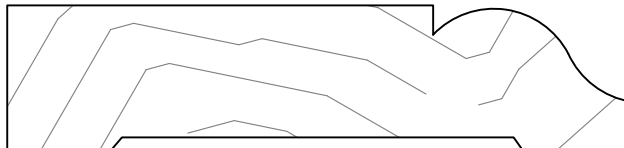

GCM226

$\frac{3}{4} \times \text{VARIES}$

# GRAYCO BUILDING CENTER

WWW.GRAYCOINC.COM

BLUFFTON  
345 BUCK ISLAND RD, BLUFFTON SC 29910  
(843) 815-5788 FAX 815-5799

LADY'S ISLAND  
20 SAMS POINT WAY, BEAUFORT SC 29907  
(843) 522-9994 FAX 522-9972

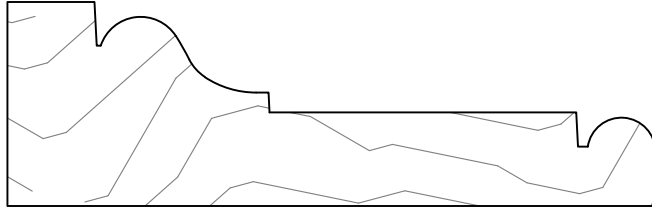

GCM209  
 $1\frac{1}{16} \times 3\frac{3}{8}$ "

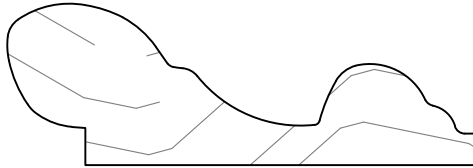

GCM7007  
 $1\frac{3}{16} \times 2\frac{7}{16}$

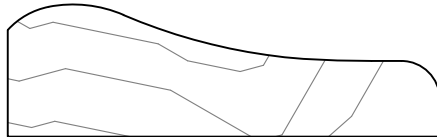

GCM1529  
 $1\frac{1}{16} \times 2\frac{1}{4}$



GCM1038  
 $1\frac{1}{32} \times 5$ "

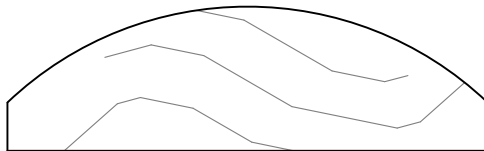

GCM1043  
 $\frac{3}{4} \times 2\frac{1}{2}$

# GRAYCO BUILDING CENTER

WWW.GRAYCOINC.COM

BLUFFTON  
345 BUCK ISLAND RD, BLUFFTON SC 29910  
(843) 815-5788 FAX 815-5799

LADY'S ISLAND  
20 SAMS POINT WAY, BEAUFORT SC 29907  
(843) 522-9994 FAX 522-9972

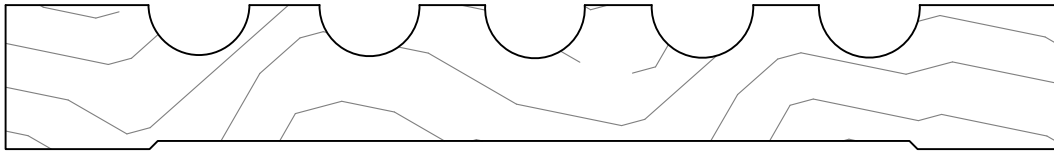

GCM1007  
 $\frac{3}{4} \times 5\frac{1}{2}$

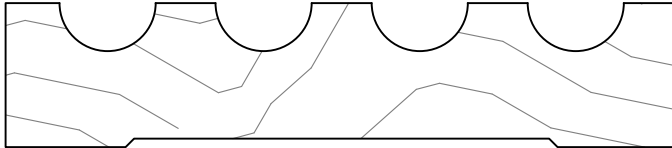

GCM1430  
 $\frac{3}{4} \times 3\frac{1}{2}$

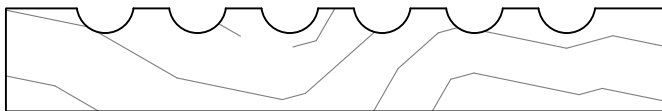

GCM1159  
 $1\frac{7}{32} \times 3\frac{7}{16}$



GCM3088  
 $\frac{3}{4} \times 3\frac{1}{2}$

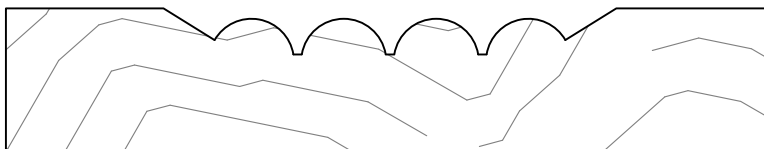

GCM1178  
 $\frac{3}{4} \times 4$

# GRAYCO BUILDING CENTER

WWW.GRAYCOINC.COM

BLUFFTON  
345 BUCK ISLAND RD, BLUFFTON SC 29910  
(843) 815-5788 FAX 815-5799

LADY'S ISLAND  
20 SAMS POINT WAY, BEAUFORT SC 29907  
(843) 522-9994 FAX 522-9972

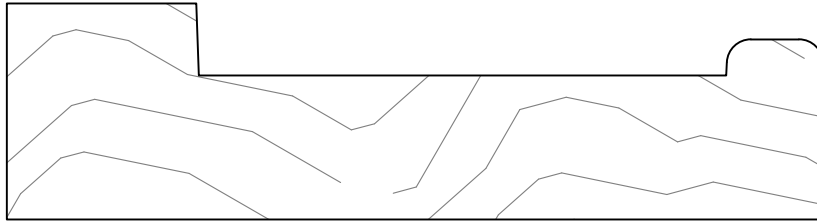

GCM1172  
 $1\frac{1}{8} \times 4\frac{1}{4}$

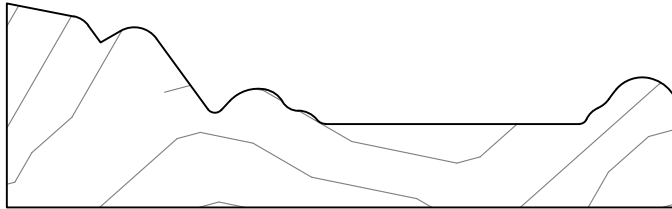

GCM1174  
 $1\frac{1}{16} \times 3\frac{1}{2}$

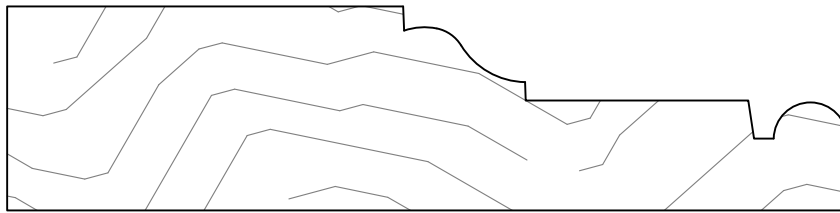

GCM1175  
 $1\frac{1}{16} \times 4\frac{3}{8}$

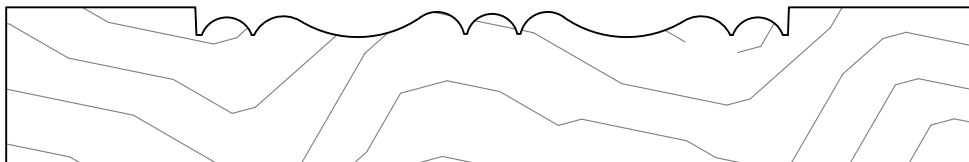

GCM1166  
 $1\frac{3}{16} \times 5\frac{1}{16}$



GCM190  
 $1\frac{1}{4} \times 4\frac{1}{2}$

# GRAYCO BUILDING CENTER

WWW.GRAYCOINC.COM

BLUFFTON  
345 BUCK ISLAND RD, BLUFFTON SC 29910  
(843) 815-5788 FAX 815-5799

LADY'S ISLAND  
20 SAMS POINT WAY, BEAUFORT SC 29907  
(843) 522-9994 FAX 522-9972



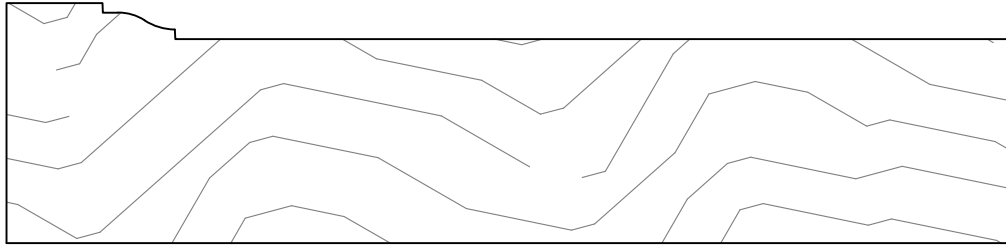

GCM180  
1¼ x VARIES (2¾" STANDARD EXT DOOR)

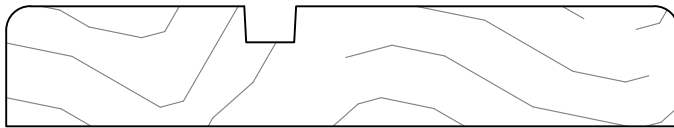

GCM1035  
⅝ X 3½"

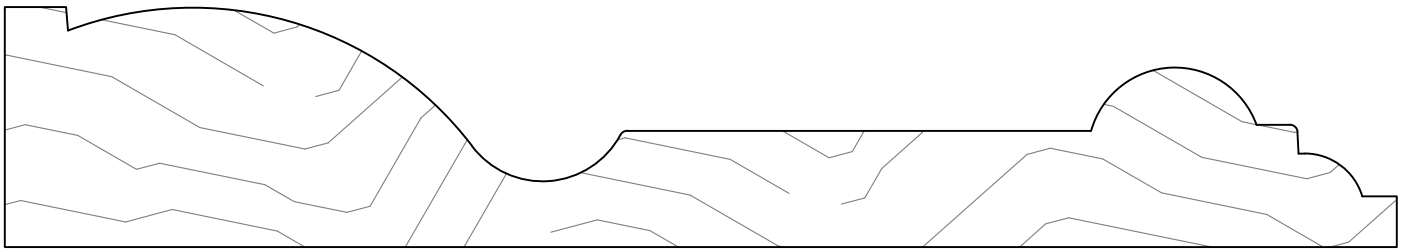

GCM1913 MOD  
1¼ X 7¼"

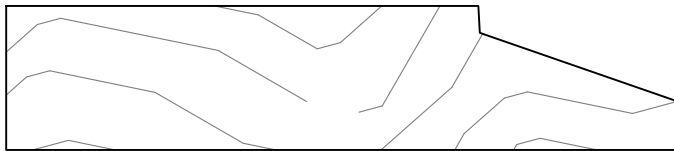

GCM459  
¾ X 3½"

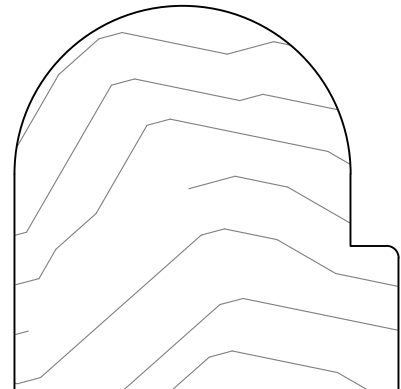

GCM4501  
2 X 2"

# GRAYCO BUILDING CENTER

WWW.GRAYCOINC.COM

BLUFFTON  
345 BUCK ISLAND RD, BLUFFTON SC 29910  
(843) 815-5788 FAX 815-5799

LADY'S ISLAND  
20 SAMS POINT WAY, BEAUFORT SC 29907  
(843) 522-9994 FAX 522-9972

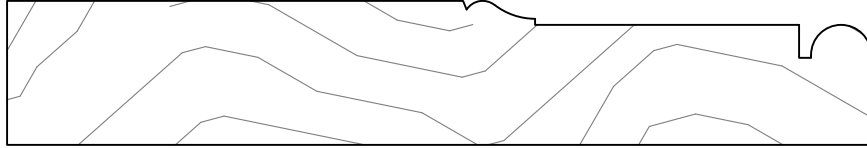

GCM1039  
 $\frac{3}{4} \times 4\frac{3}{4}$

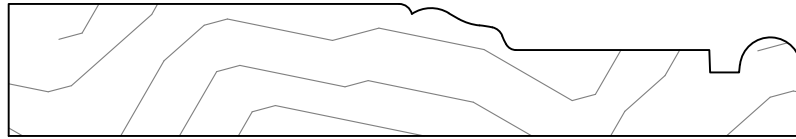

GCM1048  
 $1\frac{1}{16} \times 4\frac{1}{8}$



GCM1047  
 $\frac{7}{8} \times 7$



GCM1046  
 $\frac{7}{8} \times 5\frac{1}{2}$

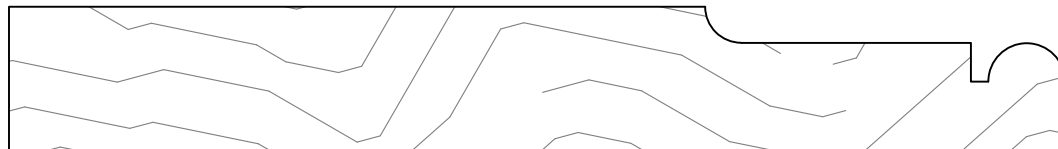

GCM1362  
 $\frac{3}{4} \times 5\frac{1}{2}$

# GRAYCO BUILDING CENTER

WWW.GRAYCOINC.COM

BLUFFTON  
345 BUCK ISLAND RD, BLUFFTON SC 29910  
(843) 815-5788 FAX 815-5799

LADY'S ISLAND  
20 SAMS POINT WAY, BEAUFORT SC 29907  
(843) 522-9994 FAX 522-9972

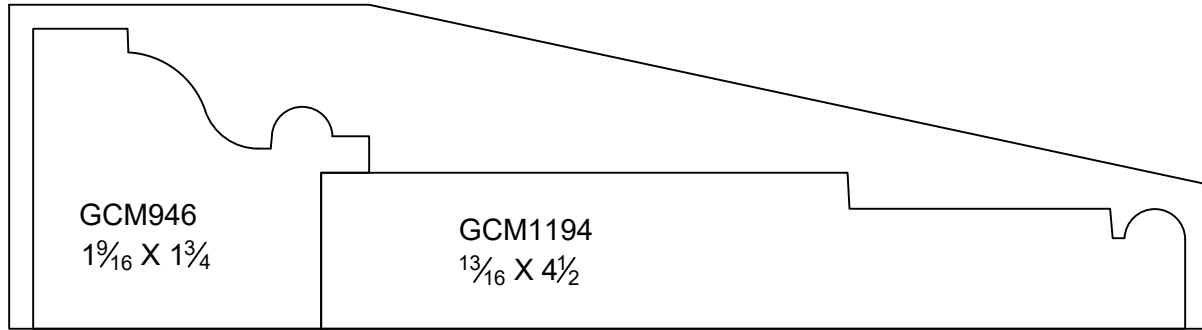

GCM946  
1<sup>9</sup>/<sub>16</sub> X 1<sup>3</sup>/<sub>4</sub>

GCM1194  
1<sup>3</sup>/<sub>16</sub> X 4<sup>1</sup>/<sub>2</sub>

GCM1151  
1<sup>1</sup>/<sub>16</sub> X 6<sup>1</sup>/<sub>4</sub>

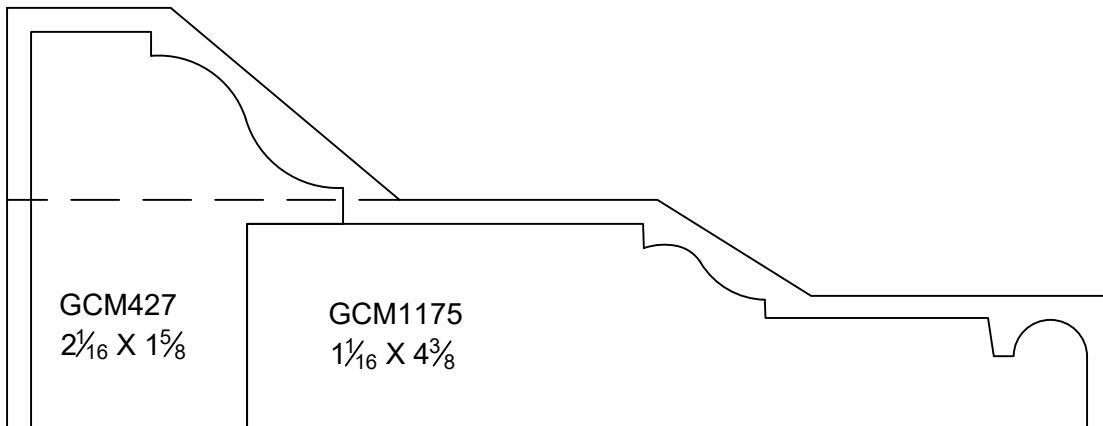

GCM427  
2<sup>1</sup>/<sub>16</sub> X 1<sup>5</sup>/<sub>8</sub>

GCM1175  
1<sup>1</sup>/<sub>16</sub> X 4<sup>3</sup>/<sub>8</sub>

GCM8018  
5<sup>3</sup>/<sub>4</sub> X 2<sup>3</sup>/<sub>16</sub>

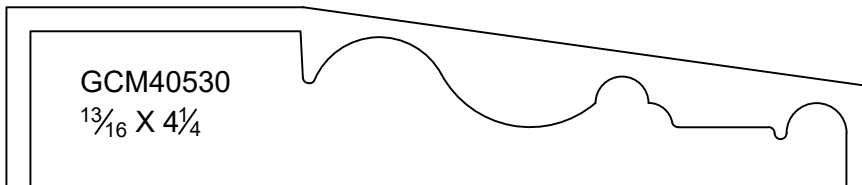

GCM40530  
1<sup>3</sup>/<sub>16</sub> X 4<sup>1</sup>/<sub>4</sub>

GCM4502  
1<sup>5</sup>/<sub>16</sub> X 4<sup>1</sup>/<sub>2</sub>"

# GRAYCO BUILDING CENTER

WWW.GRAYCOINC.COM

BLUFFTON  
345 BUCK ISLAND RD, BLUFFTON SC 29910  
(843) 815-5788 FAX 815-5799

LADY'S ISLAND  
20 SAMS POINT WAY, BEAUFORT SC 29907  
(843) 522-9994 FAX 522-9972

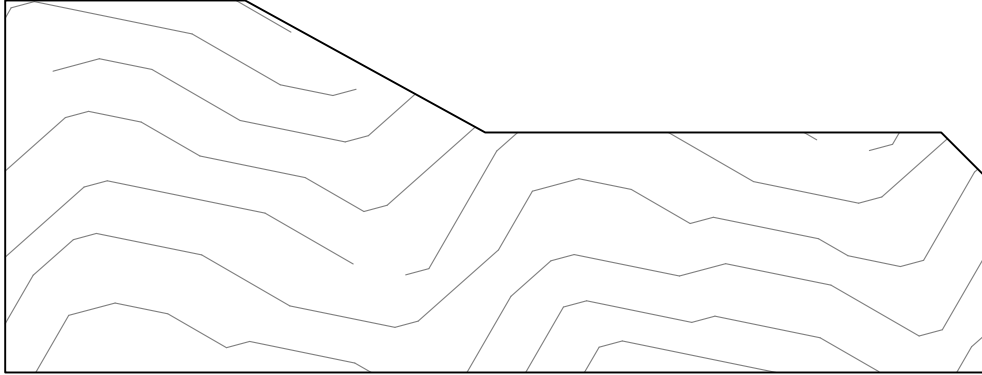

GCM518  
 $1\frac{15}{16} \times 5\frac{1}{8}$

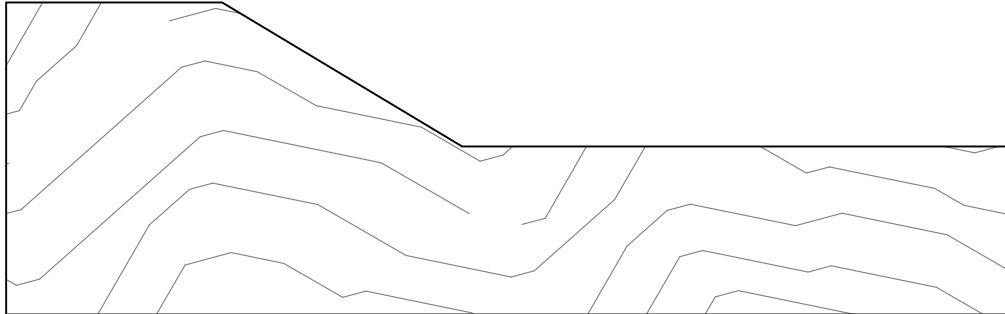

GCM6019  
 $1\frac{5}{8} \times 5\frac{1}{4}$

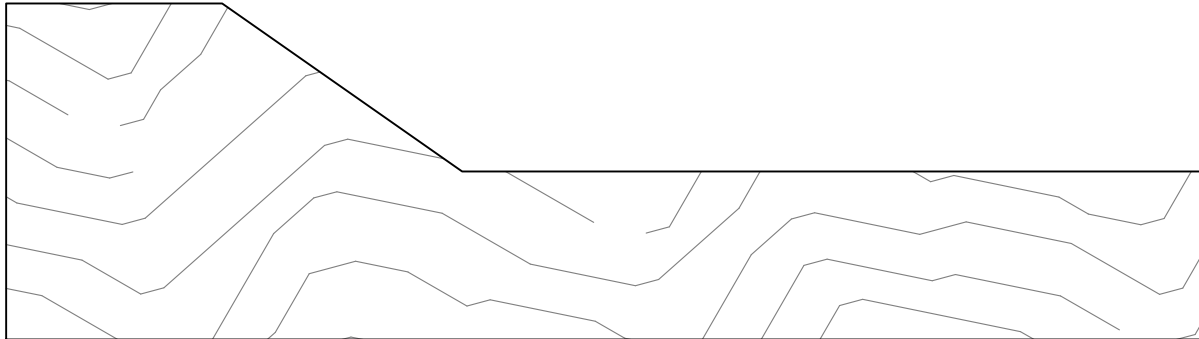

GCM6020  
 $1\frac{3}{4} \times 6\frac{1}{4}$

# GRAYCO BUILDING CENTER

[WWW.GRAYCOINC.COM](http://WWW.GRAYCOINC.COM)

BLUFFTON  
345 BUCK ISLAND RD, BLUFFTON SC 29910  
(843) 815-5788 FAX 815-5799

LADY'S ISLAND  
20 SAMS POINT WAY, BEAUFORT SC 29907  
(843) 522-9994 FAX 522-9972

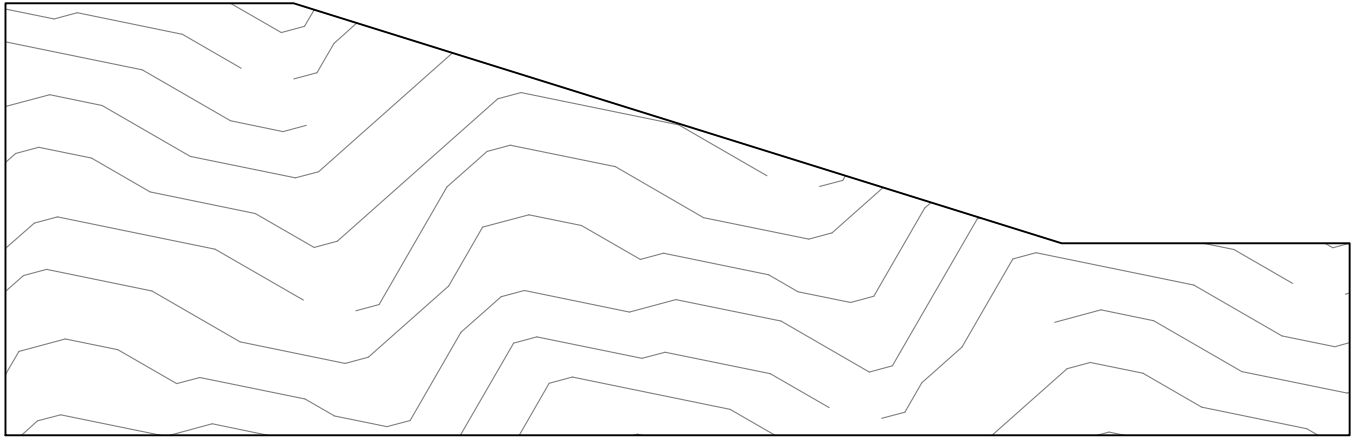

GCM6002  
2¼ X 7



GCM6007  
1⅞ X 4½

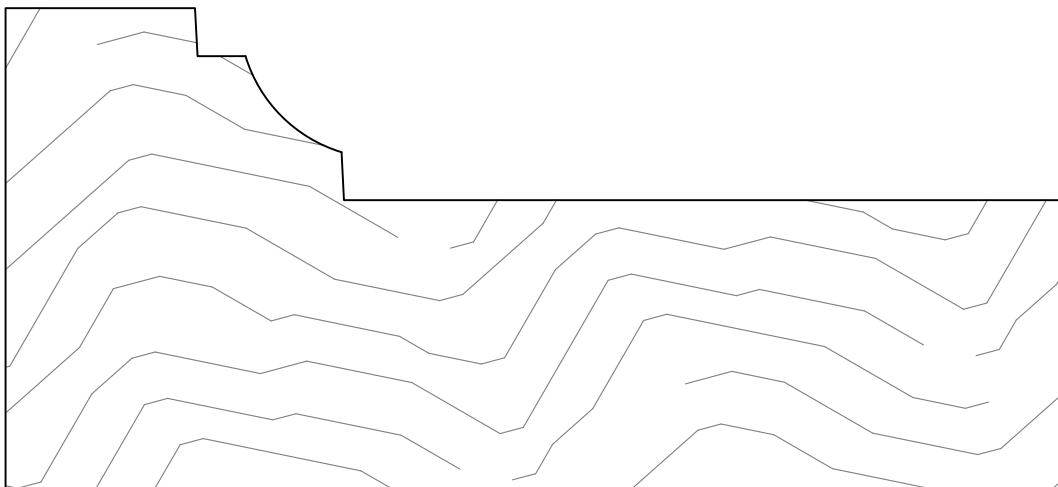

GCM10455  
2½ X 5½

# GRAYCO BUILDING CENTER

WWW.GRAYCOINC.COM

BLUFFTON  
345 BUCK ISLAND RD, BLUFFTON SC 29910  
(843) 815-5788 FAX 815-5799

LADY'S ISLAND  
20 SAMS POINT WAY, BEAUFORT SC 29907  
(843) 522-9994 FAX 522-9972

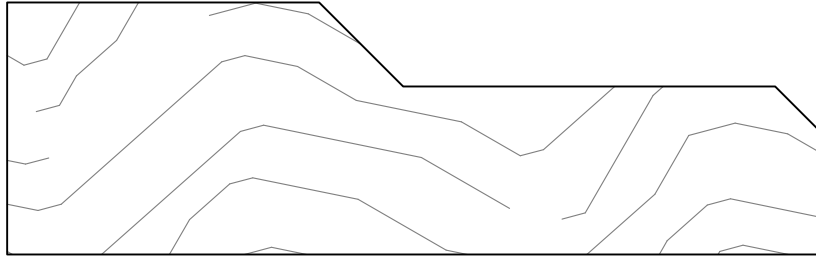

GCM60967  
1<sup>5</sup>/<sub>16</sub> X 4<sup>1</sup>/<sub>4</sub>

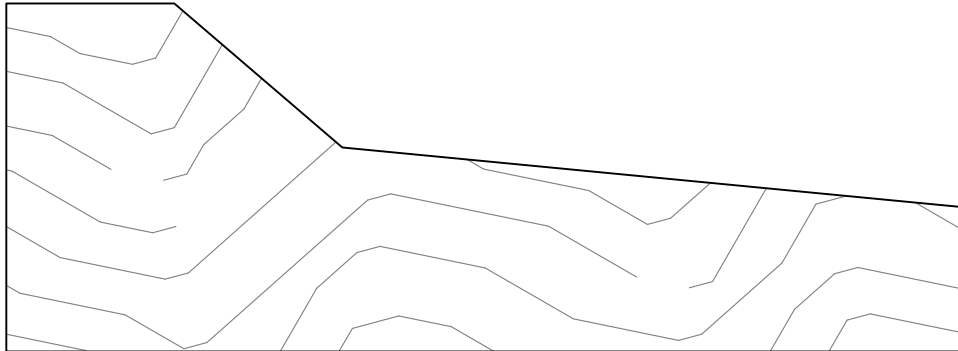

GCM2804  
1<sup>13</sup>/<sub>16</sub> X 5

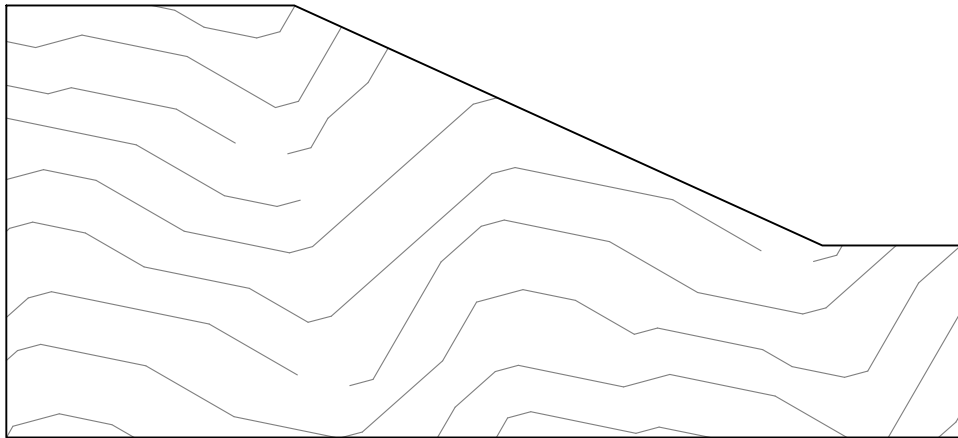

GCM6001  
2<sup>1</sup>/<sub>4</sub> X 5

# GRAYCO BUILDING CENTER

WWW.GRAYCOINC.COM

BLUFFTON  
345 BUCK ISLAND RD, BLUFFTON SC 29910  
(843) 815-5788 FAX 815-5799

LADY'S ISLAND  
20 SAMS POINT WAY, BEAUFORT SC 29907  
(843) 522-9994 FAX 522-9972

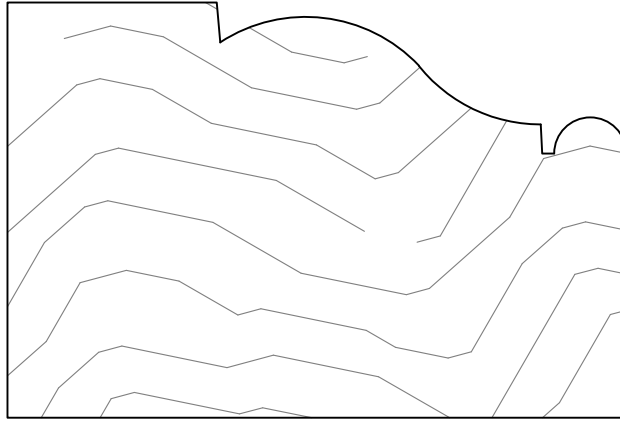

GCM104322  
 $2\frac{5}{32} \times 3\frac{1}{4}$

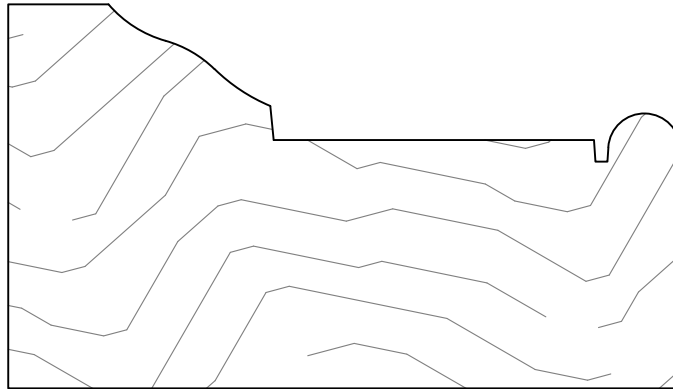

GCM1167  
 $2 \times 3\frac{1}{2}$

## GRAYCO BUILDING CENTER

[WWW.GRAYCOINC.COM](http://WWW.GRAYCOINC.COM)

BLUFFTON  
345 BUCK ISLAND RD, BLUFFTON SC 29910  
(843) 815-5788 FAX 815-5799

LADY'S ISLAND  
20 SAMS POINT WAY, BEAUFORT SC 29907  
(843) 522-9994 FAX 522-9972

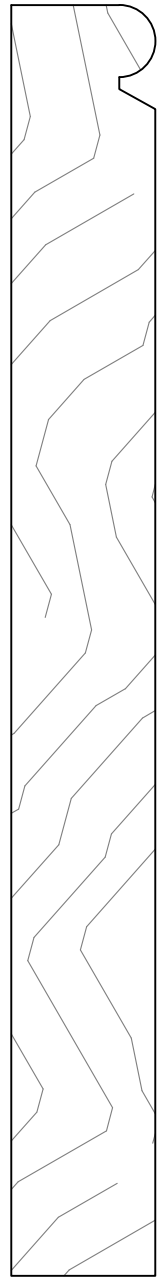
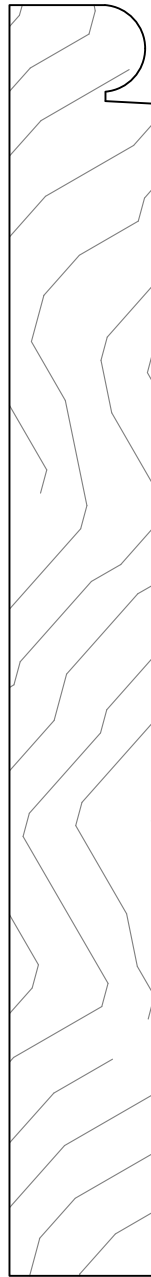
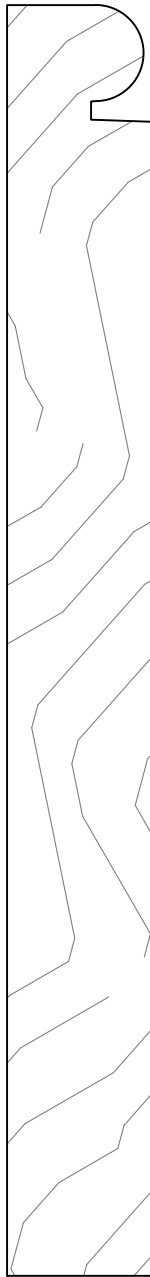
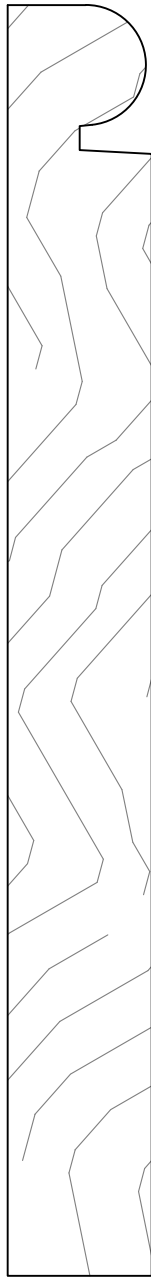
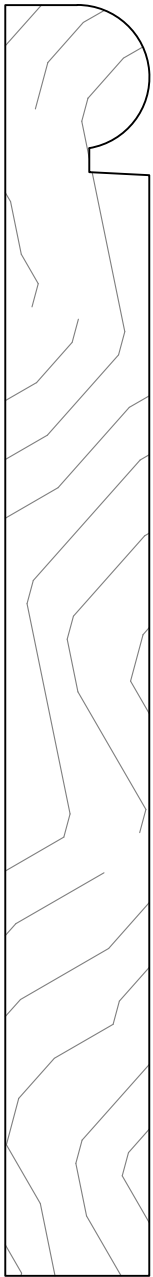

GCM1034  
3/4 x VARIES

GCM1514  
3/4 x VARIES

GCM650  
3/4 X VARIES

GCM40925  
3/4 x VARIES

GCM1547  
3/4 X VARIES

GCM1759B  
3/4 x VARIES

# GRAYCO BUILDING CENTER

WWW.GRAYCOINC.COM

BLUFFTON  
345 BUCK ISLAND RD, BLUFFTON SC 29910  
(843) 815-5788 FAX 815-5799

LADY'S ISLAND  
20 SAMS POINT WAY, BEAUFORT SC 29907  
(843) 522-9994 FAX 522-9972



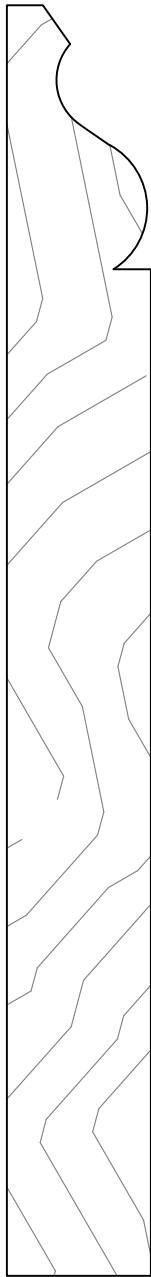

GCM  
SPEED BASE  
3/4 x VARIES



GCM40125  
3/4 x VARIES

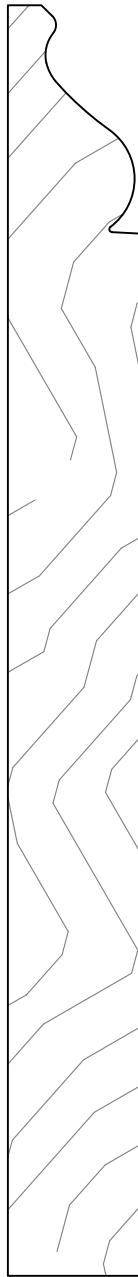

GCM1515  
3/4 X VARIES

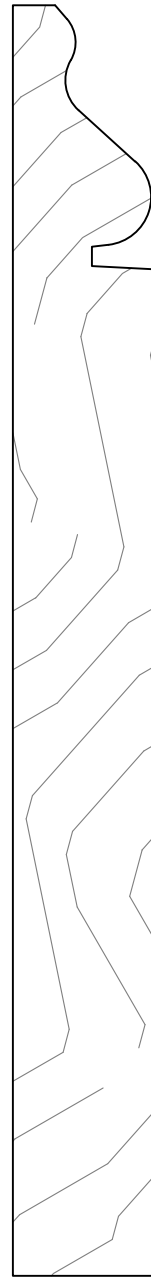

GCM1334  
3/4 X VARIES

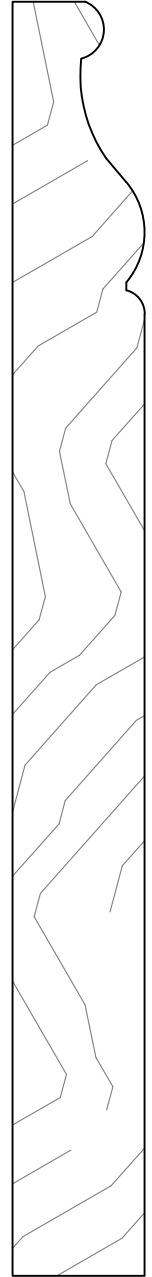

GCM1542  
1 1/16 X VARIES

# GRAYCO BUILDING CENTER

WWW.GRAYCOINC.COM

BLUFFTON  
345 BUCK ISLAND RD, BLUFFTON SC 29910  
(843) 815-5788 FAX 815-5799

LADY'S ISLAND  
20 SAMS POINT WAY, BEAUFORT SC 29907  
(843) 522-9994 FAX 522-9972

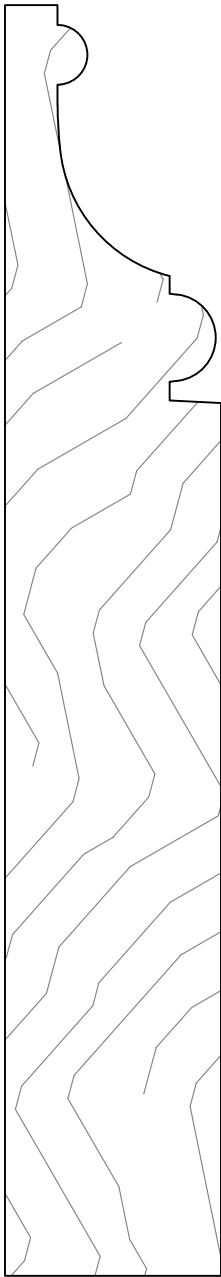

GCM1510  
1 1/8 x VARIES

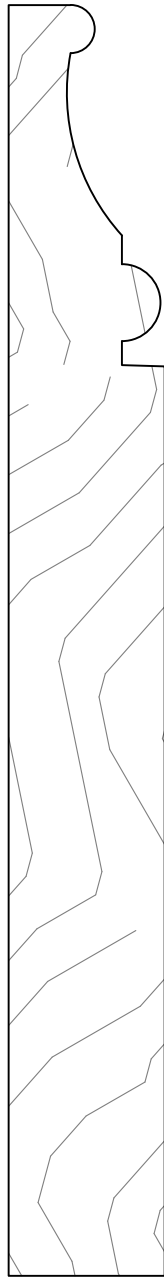

GCM713  
1 3/16 x VARIES

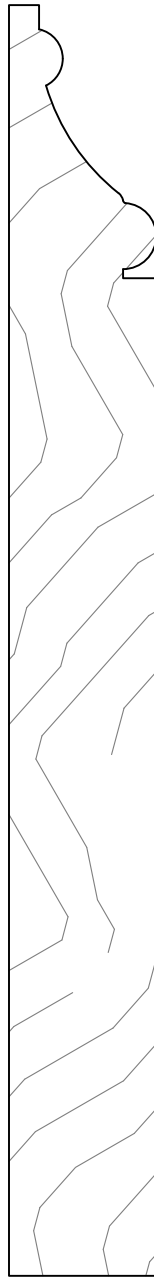

GCM4095  
3/4 x VARIES

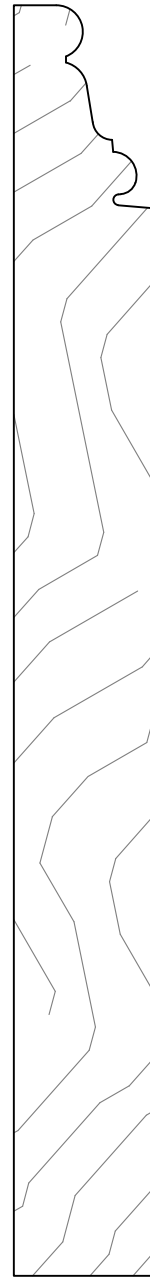

GCM1512  
3/4 x VARIES

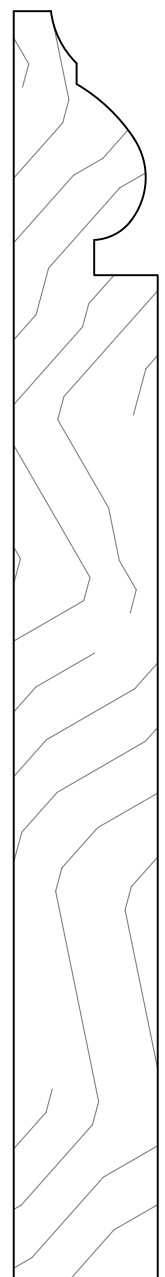

GCM1538  
3/4 X VARIES

# GRAYCO BUILDING CENTER

WWW.GRAYCOINC.COM

BLUFFTON  
345 BUCK ISLAND RD, BLUFFTON SC 29910  
(843) 815-5788 FAX 815-5799

LADY'S ISLAND  
20 SAMS POINT WAY, BEAUFORT SC 29907  
(843) 522-9994 FAX 522-9972

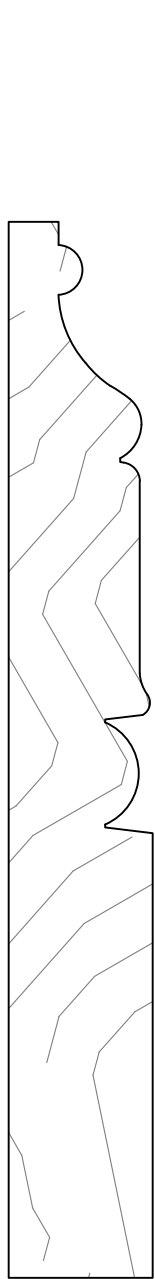

GCM1511  
3/4 X 5 1/2

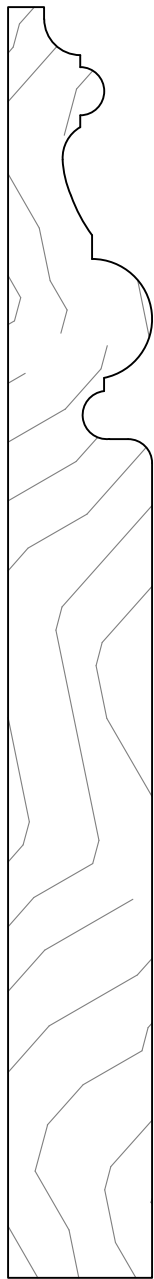

GCM695M2  
3/4 x VARIES

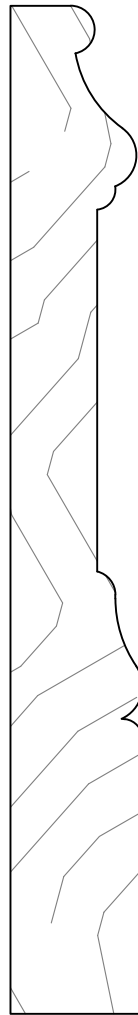

GCM467  
1 1/16 X 5 1/4



GCM1548  
9/16 X 5 1/4

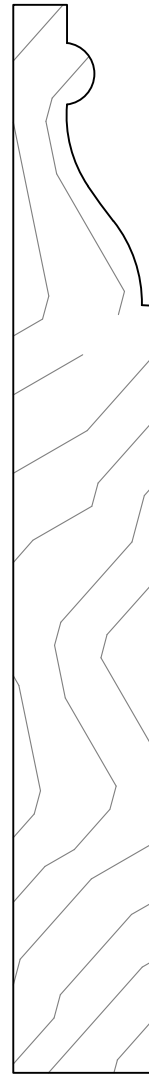

GCM1527  
3/4 X 5 9/16"

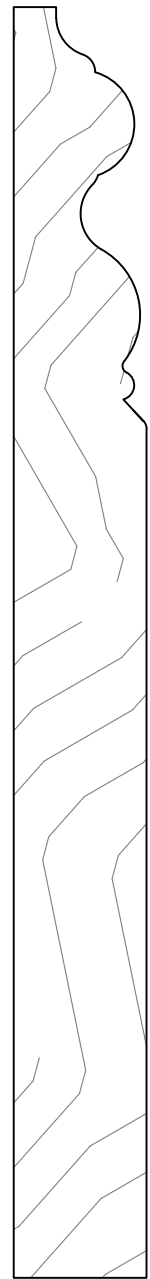

GCM44655  
1 1/16 X VARIES

# GRAYCO BUILDING CENTER

WWW.GRAYCOINC.COM

BLUFFTON  
345 BUCK ISLAND RD, BLUFFTON SC 29910  
(843) 815-5788 FAX 815-5799

LADY'S ISLAND  
20 SAMS POINT WAY, BEAUFORT SC 29907  
(843) 522-9994 FAX 522-9972

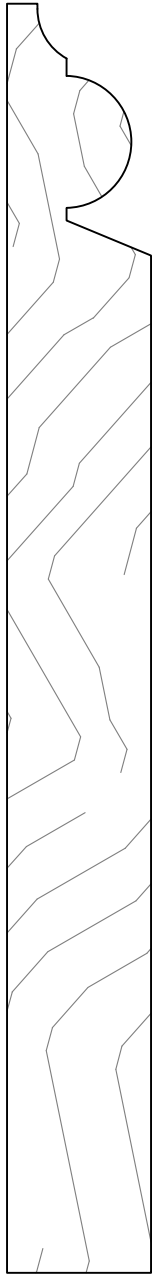

GCM1229  
3/4 X VARIES

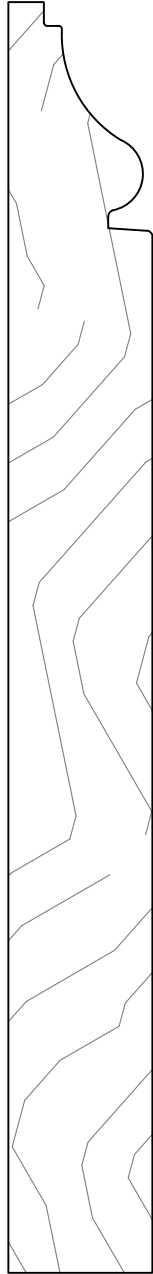

GCM663  
3/4 x VARIES

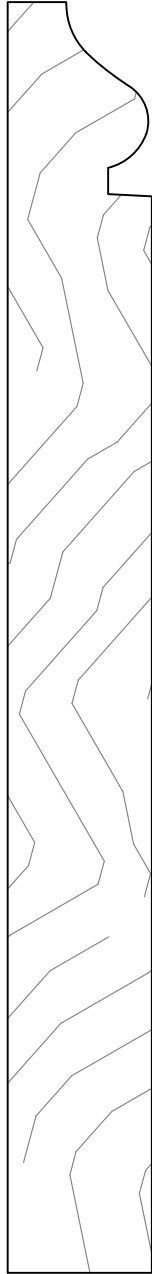

GCM1507  
3/4 x VARIES



GCM573  
1 x VARIES

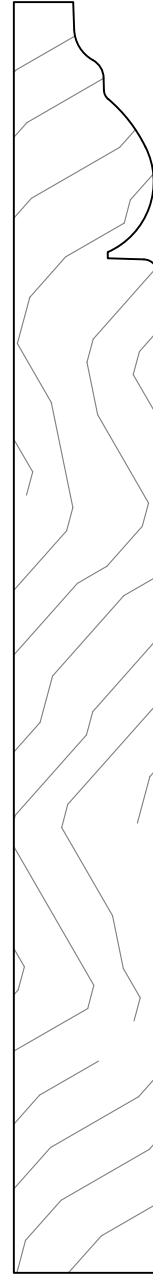

GCM1546  
3/4 X 7/4

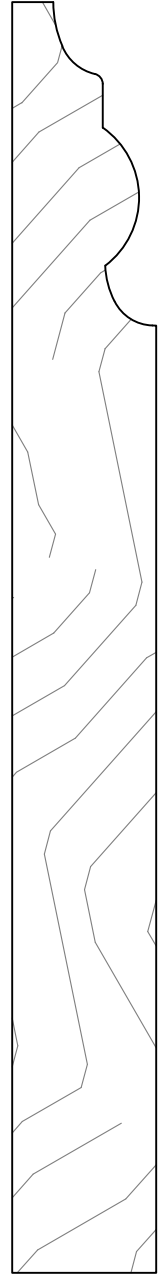

GCM1506  
3/4 x VARIES

# GRAYCO BUILDING CENTER

WWW.GRAYCOINC.COM

BLUFFTON  
345 BUCK ISLAND RD, BLUFFTON SC 29910  
(843) 815-5788 FAX 815-5799

LADY'S ISLAND  
20 SAMS POINT WAY, BEAUFORT SC 29907  
(843) 522-9994 FAX 522-9972

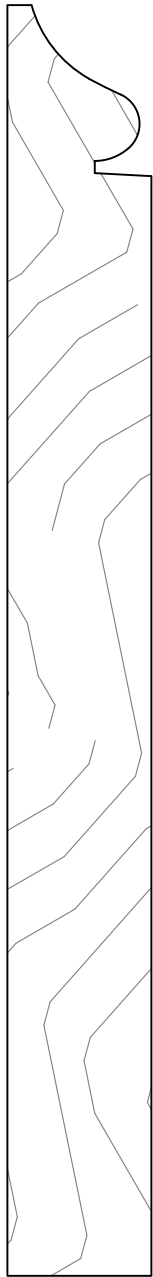

GCM1524  
3/4 X VARIES

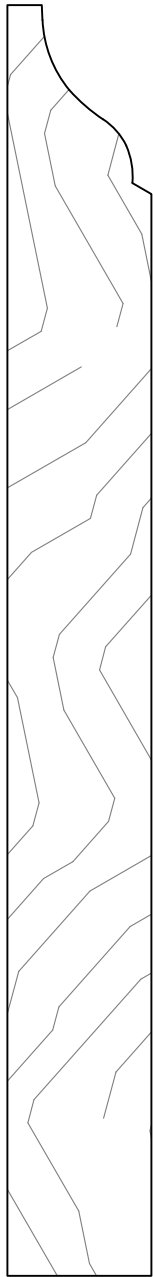

GCM1807  
3/4 x VARIES

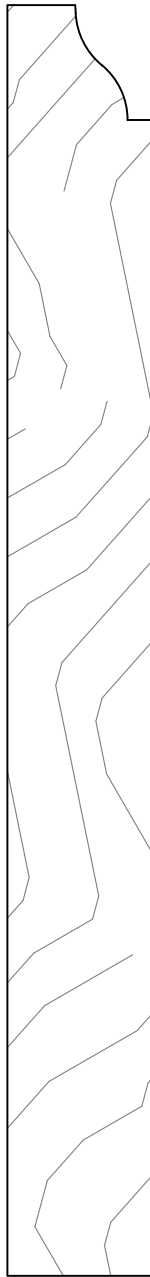

GCM1513  
3/4 x VARIES

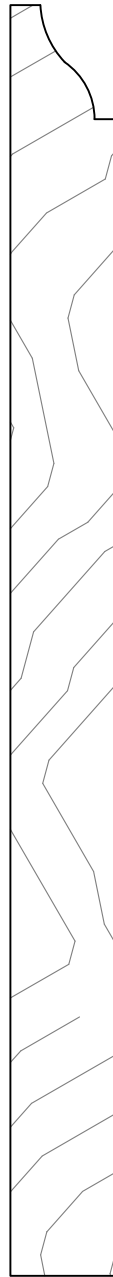

GCM620  
9/16 x VARIES

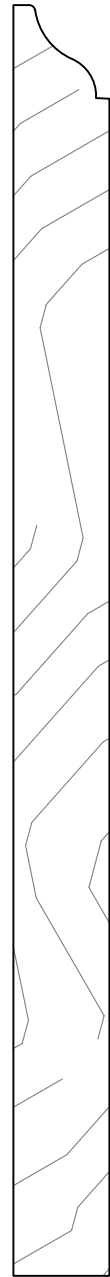

GCM1016  
1/2 x VARIES

# GRAYCO BUILDING CENTER

WWW.GRAYCOINC.COM

BLUFFTON  
345 BUCK ISLAND RD, BLUFFTON SC 29910  
(843) 815-5788 FAX 815-5799

LADY'S ISLAND  
20 SAMS POINT WAY, BEAUFORT SC 29907  
(843) 522-9994 FAX 522-9972

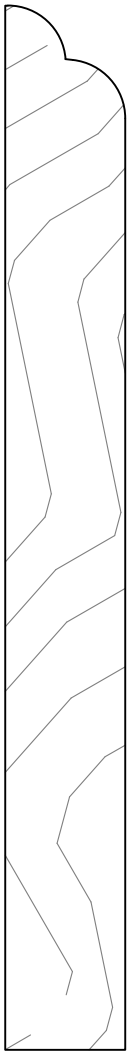

GCM665  
5/8 X VARIES

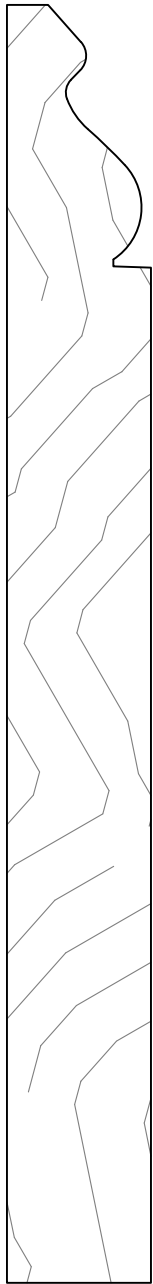

GCM1549  
3/4 X VARIES

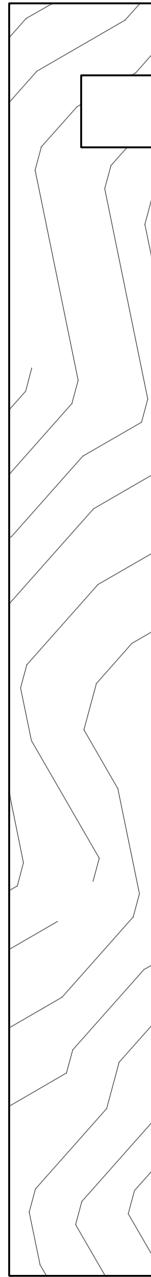

GCM1550  
3/4 X VARIES

# GRAYCO BUILDING CENTER

WWW.GRAYCOINC.COM

BLUFFTON  
345 BUCK ISLAND RD, BLUFFTON SC 29910  
(843) 815-5788 FAX 815-5799

LADY'S ISLAND  
20 SAMS POINT WAY, BEAUFORT SC 29907  
(843) 522-9994 FAX 522-9972



GCM617  
1 $\frac{1}{16}$  X VARIES

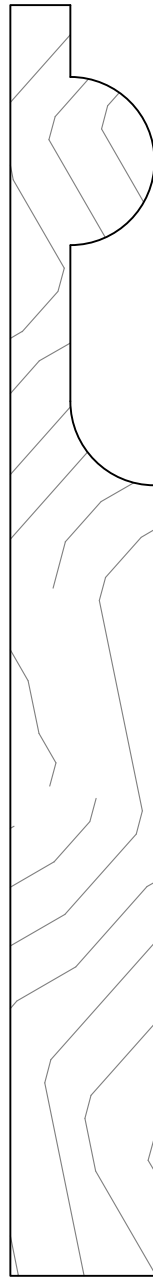

GCM44146  
3 $\frac{3}{4}$  X VARIES

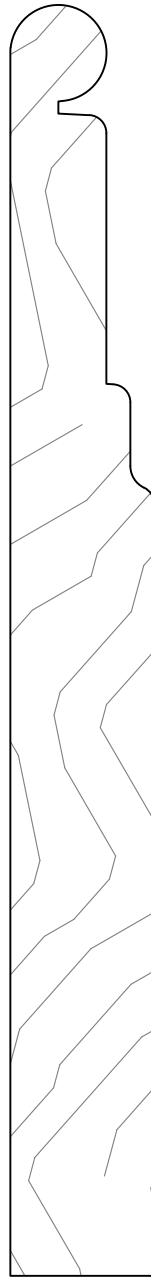

GCM715  
3 $\frac{3}{4}$  X VARIES



GCM1526  
5 $\frac{5}{8}$  X 6"

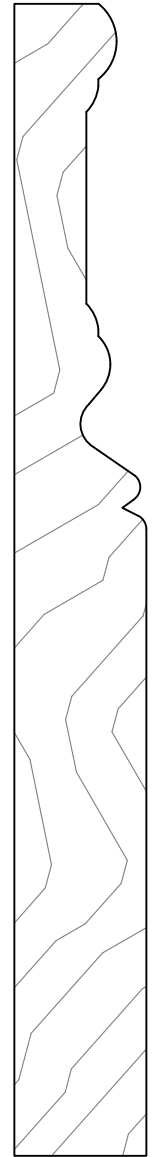

GCM66875  
1 $\frac{1}{16}$  X 6"

# GRAYCO BUILDING CENTER

WWW.GRAYCOINC.COM

BLUFFTON  
345 BUCK ISLAND RD, BLUFFTON SC 29910  
(843) 815-5788 FAX 815-5799

LADY'S ISLAND  
20 SAMS POINT WAY, BEAUFORT SC 29907  
(843) 522-9994 FAX 522-9972

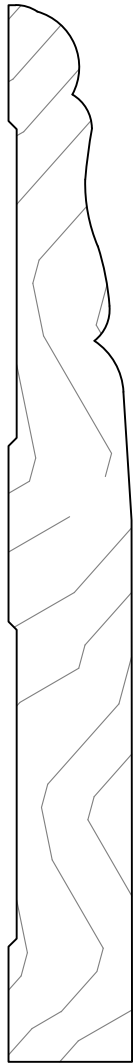

GCM664  
5/8 x 5 1/2"

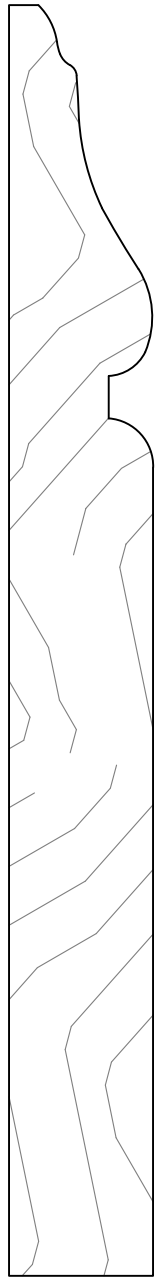

GCM1505  
3/4 x VARIES



GCM1517  
3/4 X 4 5/8"

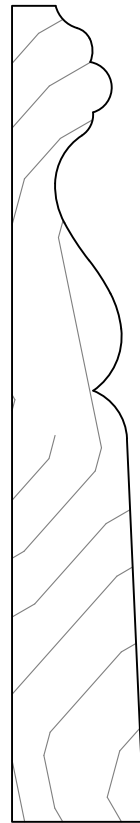

GCM1508  
1 1/16 x 4 1/4



GCM40323  
5/8 X 2 3/4"

# GRAYCO BUILDING CENTER

WWW.GRAYCOINC.COM

BLUFFTON  
345 BUCK ISLAND RD, BLUFFTON SC 29910  
(843) 815-5788 FAX 815-5799

LADY'S ISLAND  
20 SAMS POINT WAY, BEAUFORT SC 29907  
(843) 522-9994 FAX 522-9972



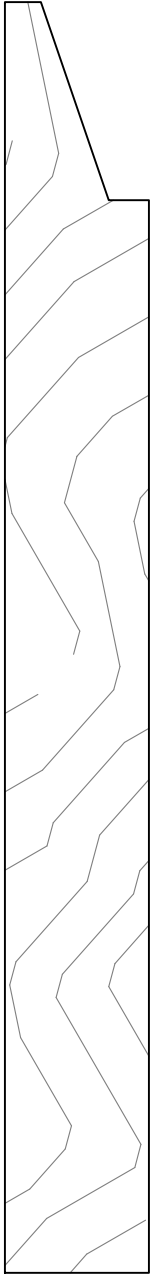

GCM115  
¾ x VARIES

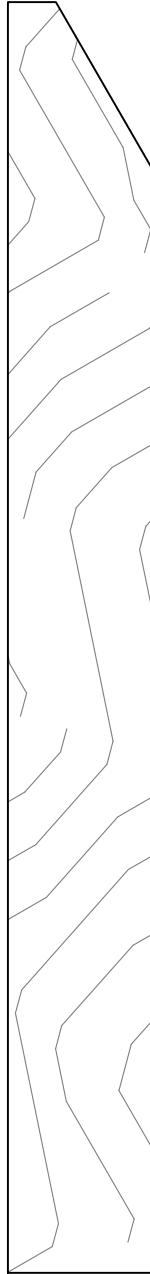

GCM1528  
¾ X VARIES



GCM40105  
¾ X VARIES



GCM1021  
¾ X VARIES

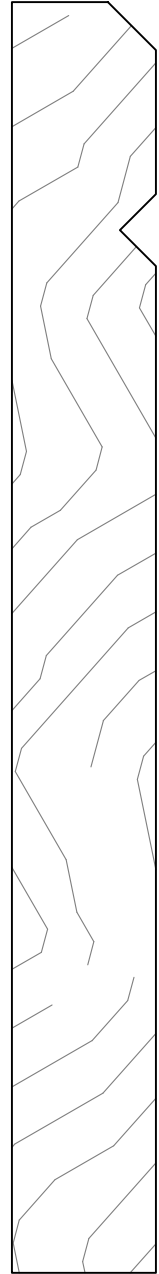

GCM1522  
¾ X VARIES

# GRAYCO BUILDING CENTER

WWW.GRAYCOINC.COM

BLUFFTON  
345 BUCK ISLAND RD, BLUFFTON SC 29910  
(843) 815-5788 FAX 815-5799

LADY'S ISLAND  
20 SAMS POINT WAY, BEAUFORT SC 29907  
(843) 522-9994 FAX 522-9972

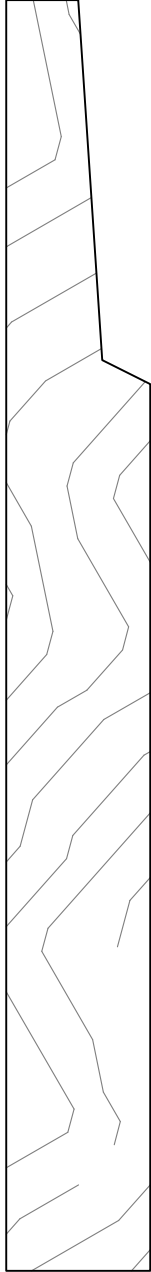

GCM40876  
3/4 x VARIES



GCM1257  
13/16 x VARIES

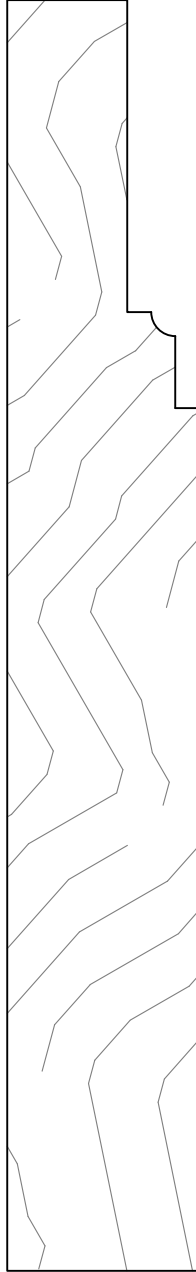

GCM1501  
1 X VARIES

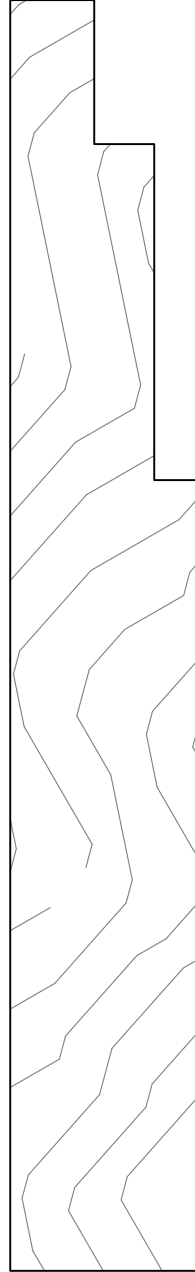

GCM1701  
1 X VARIES

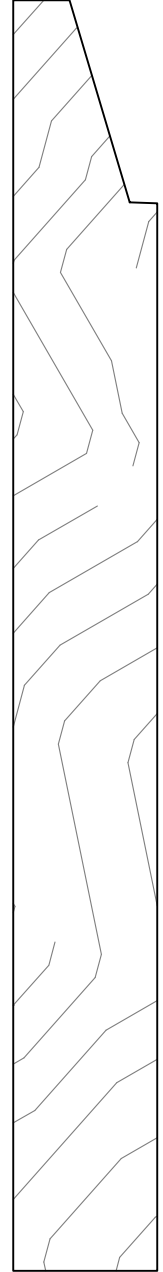

GCM1540  
3/4 X VARIES

# GRAYCO BUILDING CENTER

WWW.GRAYCOINC.COM

BLUFFTON  
345 BUCK ISLAND RD, BLUFFTON SC 29910  
(843) 815-5788 FAX 815-5799

LADY'S ISLAND  
20 SAMS POINT WAY, BEAUFORT SC 29907  
(843) 522-9994 FAX 522-9972

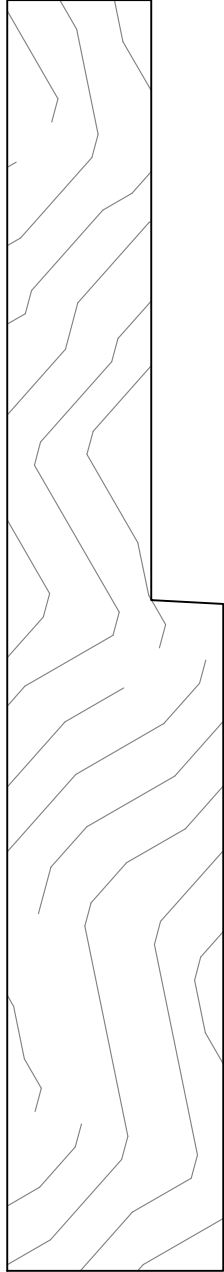

GCM6021  
1 1/8 x 7 1/2

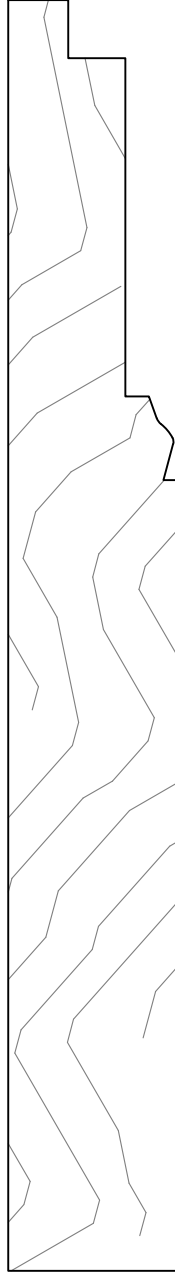

GCM40044  
7/8 X 6 15/16"



GCM1503  
1 x VARIES



GCM1518  
3/4 X VARIES

# GRAYCO BUILDING CENTER

WWW.GRAYCOINC.COM

BLUFFTON  
345 BUCK ISLAND RD, BLUFFTON SC 29910  
(843) 815-5788 FAX 815-5799

LADY'S ISLAND  
20 SAMS POINT WAY, BEAUFORT SC 29907  
(843) 522-9994 FAX 522-9972

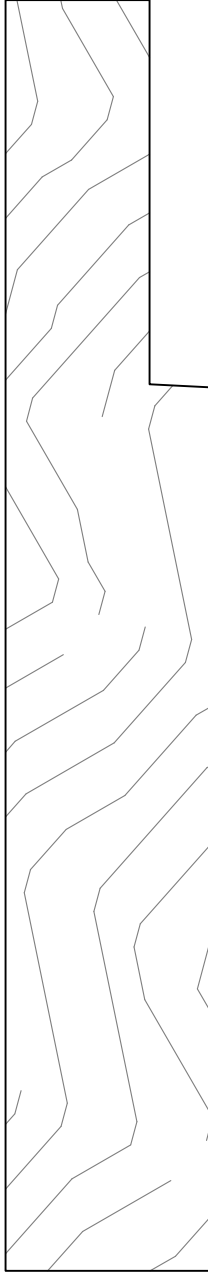

GCM1530  
1 $\frac{1}{16}$  X VARIES



GCM1535  
 $\frac{3}{4}$  X VARIES

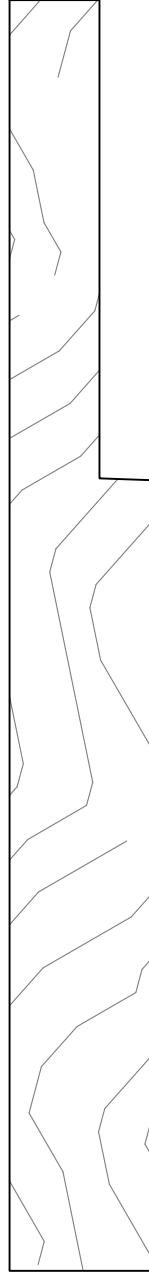

GCM1536  
 $\frac{3}{4}$  X VARIES



GCM1645  
1 X VARIES

## GRAYCO BUILDING CENTER

[WWW.GRAYCOINC.COM](http://WWW.GRAYCOINC.COM)

BLUFFTON  
345 BUCK ISLAND RD, BLUFFTON SC 29910  
(843) 815-5788 FAX 815-5799

LADY'S ISLAND  
20 SAMS POINT WAY, BEAUFORT SC 29907  
(843) 522-9994 FAX 522-9972



GCM1441  
1 x 2½

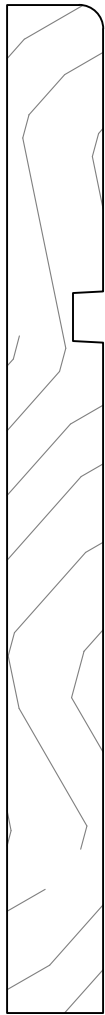

GCM1525  
½ X 5¼"



GCM1504  
5⁄8 X 2½

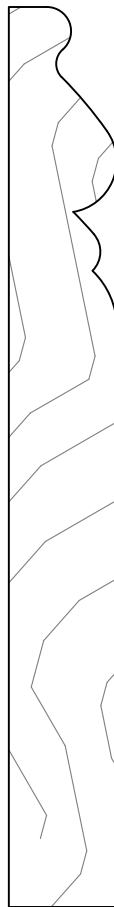

GCM1520  
9⁄16 X 4 1⁄16"

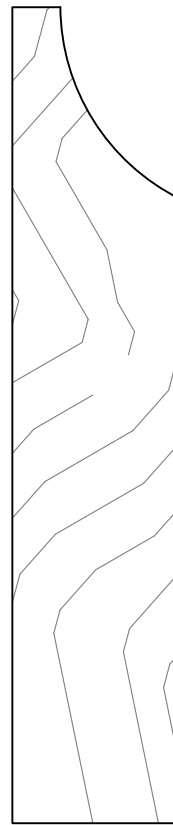

GCM4005  
7⁄8 X 4¼

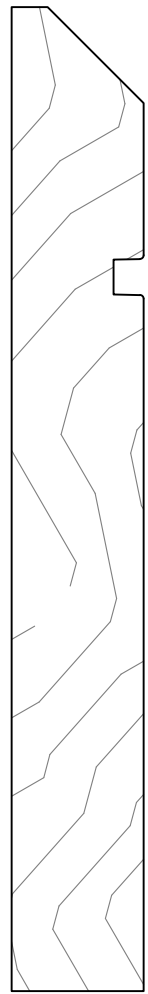

GCM1543  
1 1⁄16 X 5 1⁄8

# GRAYCO BUILDING CENTER

WWW.GRAYCOINC.COM

BLUFFTON  
345 BUCK ISLAND RD, BLUFFTON SC 29910  
(843) 815-5788 FAX 815-5799

LADY'S ISLAND  
20 SAMS POINT WAY, BEAUFORT SC 29907  
(843) 522-9994 FAX 522-9972

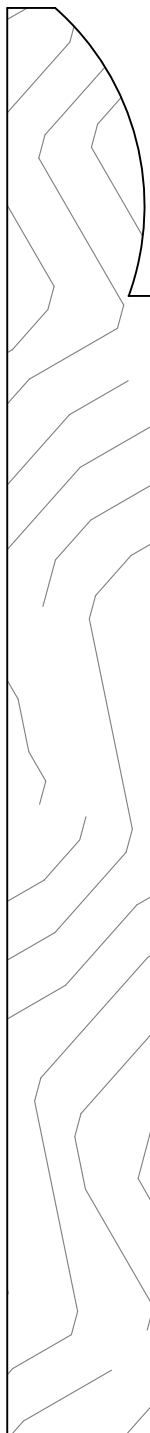

GCM1502  
 $\frac{3}{4}$  x VARIES



GCM1545  
 $\frac{3}{4}$  X VARIES

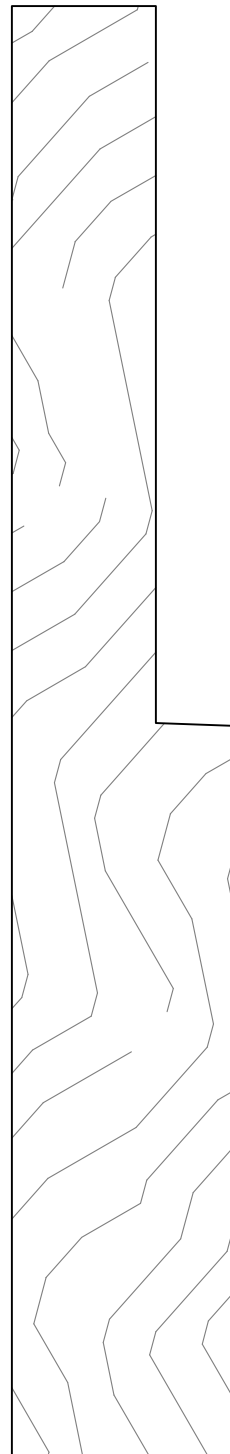

GCM1544  
 $1\frac{3}{16}$  X VARIES

# GRAYCO BUILDING CENTER

[WWW.GRAYCOINC.COM](http://WWW.GRAYCOINC.COM)

BLUFFTON  
345 BUCK ISLAND RD, BLUFFTON SC 29910  
(843) 815-5788 FAX 815-5799

LADY'S ISLAND  
20 SAMS POINT WAY, BEAUFORT SC 29907  
(843) 522-9994 FAX 522-9972

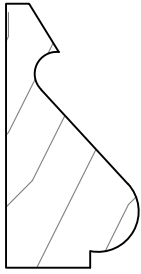

GCM163  
1<sup>1</sup>/<sub>16</sub> x 1<sup>3</sup>/<sub>8</sub>



GCM5514  
7<sup>1</sup>/<sub>16</sub> X 1<sup>1</sup>/<sub>8</sub>



GCM5523  
7<sup>1</sup>/<sub>16</sub> X 1<sup>3</sup>/<sub>16</sub>

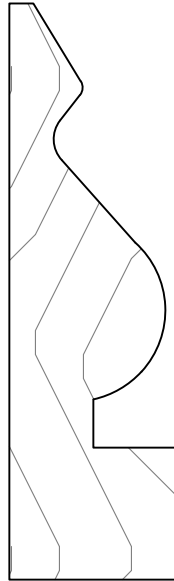

GCM189  
7<sup>7</sup>/<sub>8</sub> x 3



GCM2033  
1<sup>3</sup>/<sub>16</sub> X 2<sup>3</sup>/<sub>16</sub>

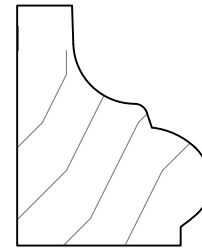

GCM2024  
1 x 1<sup>1</sup>/<sub>4</sub>

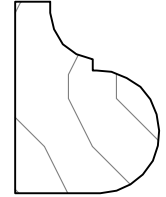

GCM1534  
3<sup>3</sup>/<sub>4</sub> x 1

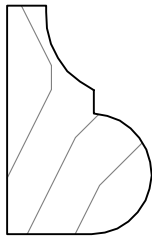

GCM1168  
3<sup>3</sup>/<sub>4</sub> x 1<sup>3</sup>/<sub>16</sub>



GCM2028  
1<sup>3</sup>/<sub>16</sub> X 1<sup>1</sup>/<sub>4</sub>



GCM2021  
1 x 1<sup>1</sup>/<sub>2</sub>



GCM5521  
9<sup>1</sup>/<sub>16</sub> X 1<sup>3</sup>/<sub>8</sub>



GCM268  
1<sup>1</sup>/<sub>16</sub> x 2<sup>1</sup>/<sub>4</sub>

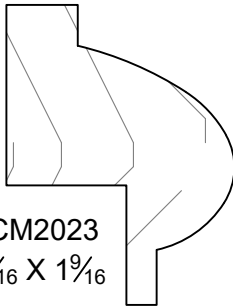

GCM2023  
1<sup>3</sup>/<sub>16</sub> X 1<sup>9</sup>/<sub>16</sub>



GCM6068  
3<sup>3</sup>/<sub>4</sub> X 1<sup>1</sup>/<sub>4</sub>

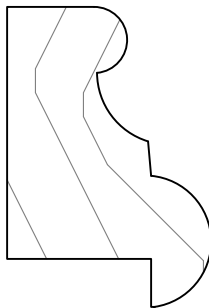

GCM42R  
1<sup>1</sup>/<sub>16</sub> x 1<sup>9</sup>/<sub>16</sub>

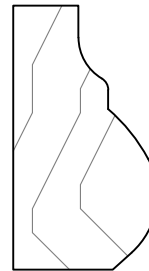

GCM2035  
3<sup>3</sup>/<sub>4</sub> X 1<sup>3</sup>/<sub>8</sub>



GCM1335  
5<sup>5</sup>/<sub>8</sub> x 1<sup>3</sup>/<sub>8</sub>



GCM42  
1<sup>1</sup>/<sub>16</sub> x 1<sup>9</sup>/<sub>16</sub>

# GRAYCO BUILDING CENTER

WWW.GRAYCOINC.COM

BLUFFTON  
345 BUCK ISLAND RD, BLUFFTON SC 29910  
(843) 815-5788 FAX 815-5799

LADY'S ISLAND  
20 SAMS POINT WAY, BEAUFORT SC 29907  
(843) 522-9994 FAX 522-9972

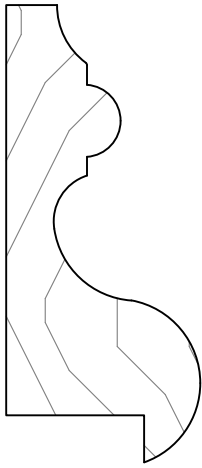

GCM1914  
1 x 2<sup>3</sup>/<sub>8</sub>

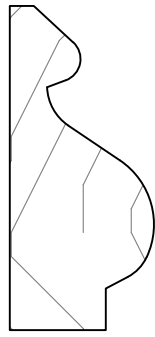

GCM2025  
3/4 x 1<sup>1</sup>/<sub>16</sub>



GCM40175  
3/4 x 1<sup>3</sup>/<sub>4</sub>



GCM40103  
3/4 x 1<sup>1</sup>/<sub>4</sub>

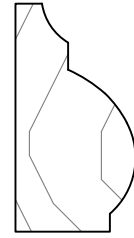

GCM2019  
5/8 x 1<sup>3</sup>/<sub>16</sub>

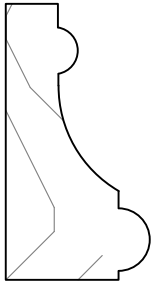

GCM2030  
3/4 x 1<sup>7</sup>/<sub>16</sub>

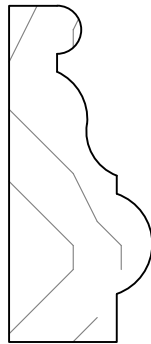

GCM641  
3/4 x 1<sup>3</sup>/<sub>4</sub>

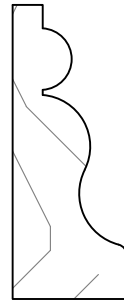

GCM2020  
9/16 x 1<sup>1</sup>/<sub>2</sub>

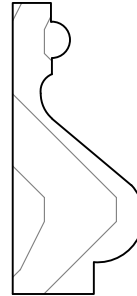

GCM214  
1<sup>1</sup>/<sub>16</sub> x 1<sup>1</sup>/<sub>2</sub>

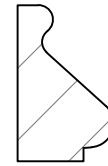

GCM5518  
1/2 x 1<sup>13</sup>/<sub>16</sub>



GCM5519  
1<sup>9</sup>/<sub>32</sub> x 1<sup>1</sup>/<sub>16</sub>



GCM5515  
3/4 x 1<sup>1</sup>/<sub>16</sub>

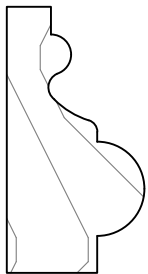

GCM40375  
3/4 x 1<sup>3</sup>/<sub>8</sub>

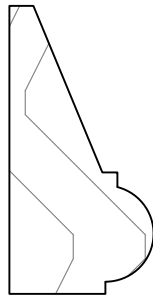

GCM6060  
3/4 x 1<sup>1</sup>/<sub>2</sub>



GCM1720  
1 x 1<sup>3</sup>/<sub>8</sub>

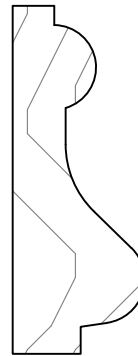

GCM2029  
1<sup>1</sup>/<sub>16</sub> x 1<sup>13</sup>/<sub>16</sub>"

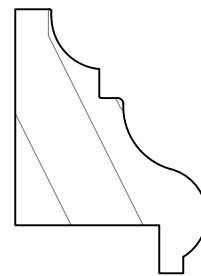

GCM739  
1 x 1<sup>3</sup>/<sub>8</sub>

# GRAYCO BUILDING CENTER

WWW.GRAYCOINC.COM

BLUFFTON  
345 BUCK ISLAND RD, BLUFFTON SC 29910  
(843) 815-5788 FAX 815-5799

LADY'S ISLAND  
20 SAMS POINT WAY, BEAUFORT SC 29907  
(843) 522-9994 FAX 522-9972



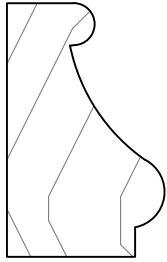

GCM133  
1<sup>3</sup>/<sub>16</sub> x 1<sup>5</sup>/<sub>16</sub>

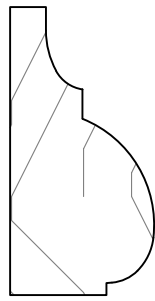

GCM574  
3/4 x 1/2

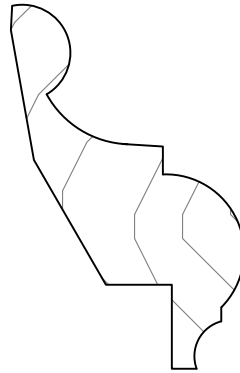

GCM4425  
1<sup>3</sup>/<sub>16</sub> x 1<sup>7</sup>/<sub>8</sub>

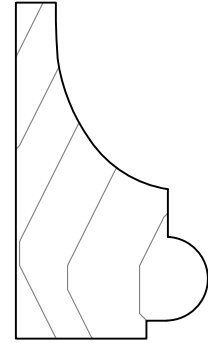

GCM94  
1 x 1<sup>3</sup>/<sub>4</sub>

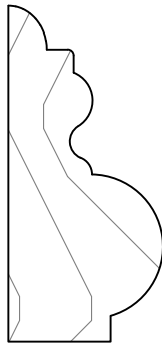

GCM44175  
1<sup>3</sup>/<sub>16</sub> x 1<sup>3</sup>/<sub>4</sub>

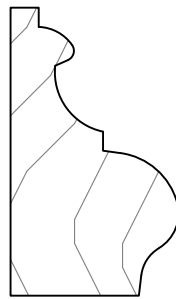

GCM2034  
7/8 x 1/2

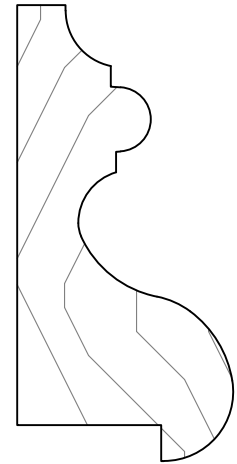

GCM14  
1/8 x 2<sup>3</sup>/<sub>8</sub>

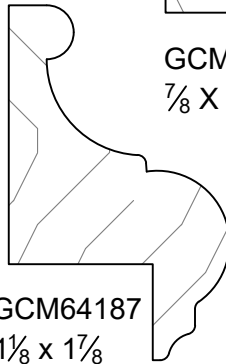

GCM64187  
1/8 x 1<sup>7</sup>/<sub>8</sub>

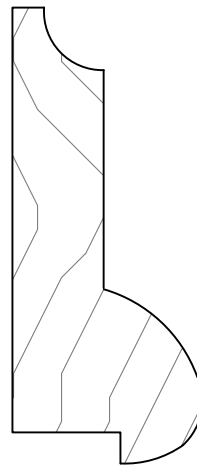

GCM1720M  
1 x 2<sup>3</sup>/<sub>8</sub>

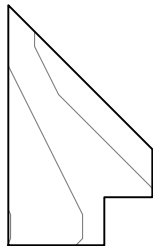

GCM424  
3/4 x 1/4

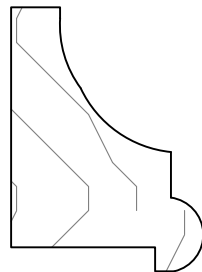

GCM80  
1 x 1<sup>3</sup>/<sub>8</sub>

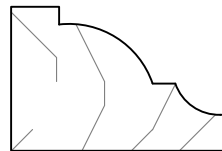

GCM914  
3/4 x 1/8

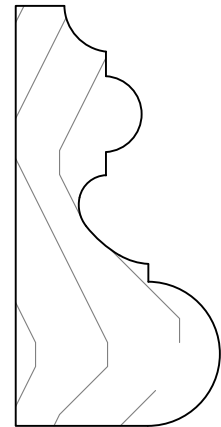

GCM932  
1/16 x 2<sup>3</sup>/<sub>16</sub>

# GRAYCO BUILDING CENTER

WWW.GRAYCOINC.COM

BLUFFTON  
345 BUCK ISLAND RD, BLUFFTON SC 29910  
(843) 815-5788 FAX 815-5799

LADY'S ISLAND  
20 SAMS POINT WAY, BEAUFORT SC 29907  
(843) 522-9994 FAX 522-9972

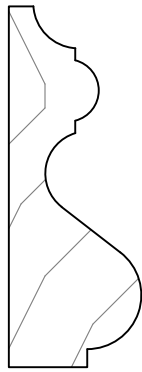

GCM934  
1 $\frac{1}{16}$  X 1 $\frac{7}{8}$

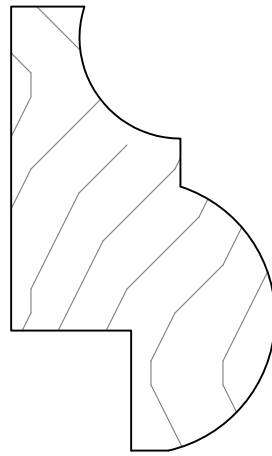

GCM2001  
1 $\frac{3}{8}$  X 2 $\frac{5}{16}$

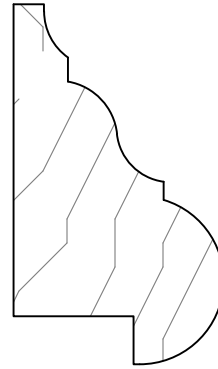

GCM5520  
1 $\frac{3}{32}$  X 1 $\frac{7}{8}$

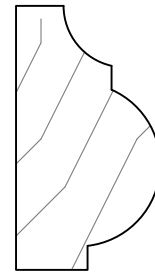

GCM2002  
 $\frac{3}{4}$  X 1 $\frac{3}{8}$

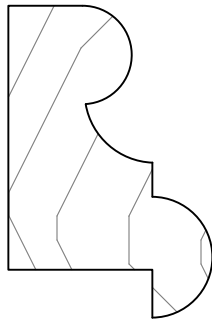

GCM2003  
1 $\frac{1}{16}$  X 1 $\frac{5}{8}$



GCM3055  
1 $\frac{1}{4}$  X 2 $\frac{5}{16}$

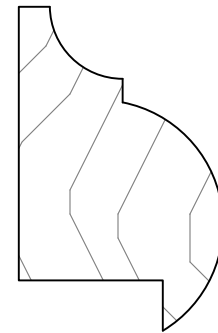

GCM672  
1 $\frac{1}{16}$  X 1 $\frac{11}{16}$

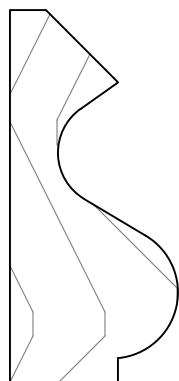

GCM2004  
 $\frac{7}{8}$  X 1 $\frac{15}{16}$

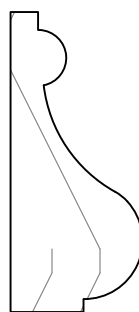

GCM977  
1 $\frac{1}{16}$  X 1 $\frac{9}{16}$

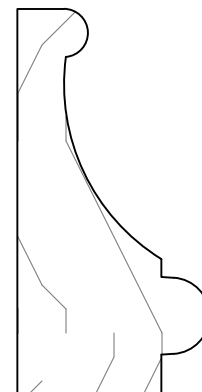

GCM198  
1 X 2

# GRAYCO BUILDING CENTER

WWW.GRAYCOINC.COM

BLUFFTON  
345 BUCK ISLAND RD, BLUFFTON SC 29910  
(843) 815-5788 FAX 815-5799

LADY'S ISLAND  
20 SAMS POINT WAY, BEAUFORT SC 29907  
(843) 522-9994 FAX 522-9972

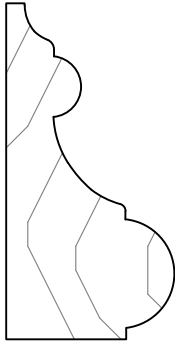

GCM2008  
7/8 x 1 3/4

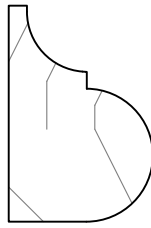

GCM2006  
3/4 x 1 1/8

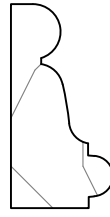

GCM2010  
1 7/32 X 1 1/16



GCM2007  
1 3/16 x 1 5/16

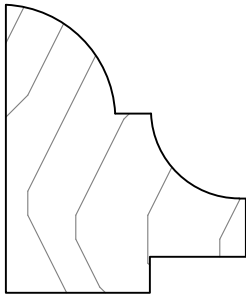

GCM1539  
1 1/2 X 1 1/4"

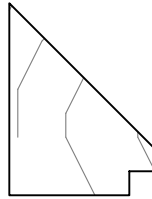

GCM453  
3/4 X 1



GCM31  
1 3/16 X 1 3/16"

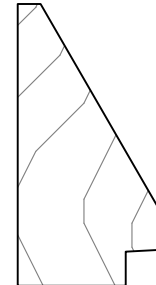

GCM2012  
3/4 X 1 7/16"

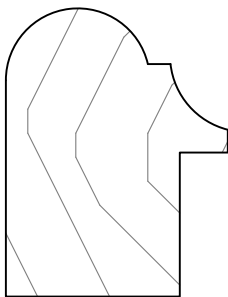

GCM1085  
VARIES X 1 5/32"



GCM2017  
1 X 2"

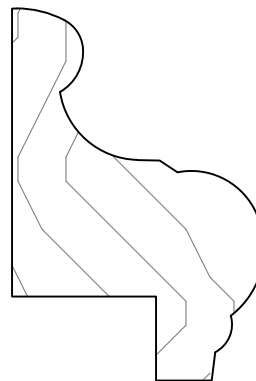

GCM36  
1 5/16 X 1 15/16"

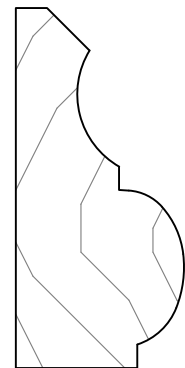

GCM1111  
7/8 X 1 7/8

# GRAYCO BUILDING CENTER

WWW.GRAYCOINC.COM

BLUFFTON  
345 BUCK ISLAND RD, BLUFFTON SC 29910  
(843) 815-5788 FAX 815-5799

LADY'S ISLAND  
20 SAMS POINT WAY, BEAUFORT SC 29907  
(843) 522-9994 FAX 522-9972

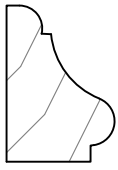

GCM1808  
9/16 X 13/16

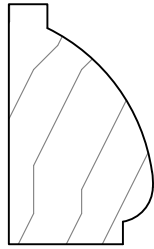

GCM431  
3/4 X 1 1/4



GCM1676  
1 3/8 X 2 1/8

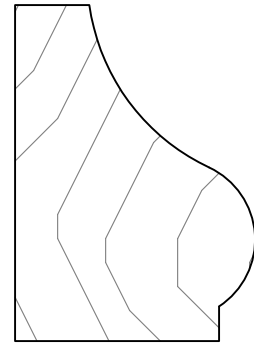

GCM2027  
1 1/4 X 1 3/4

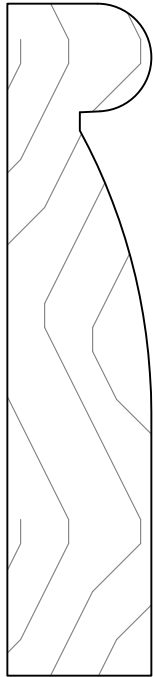

GCM1533  
3/4 X 3 1/2

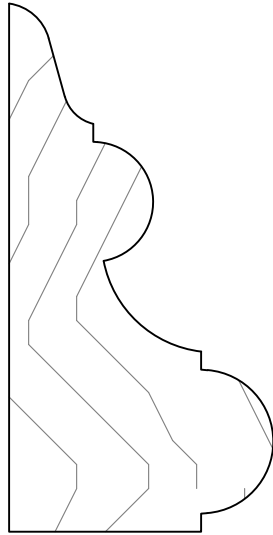

GCM2026  
1 3/8 X 2 3/4

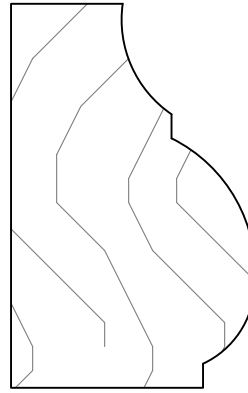

GCM573BC  
1 1/4 x 2

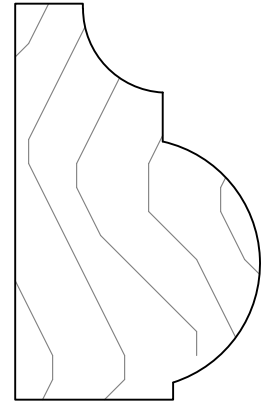

GCM8021  
1 5/16 X 2 1/16

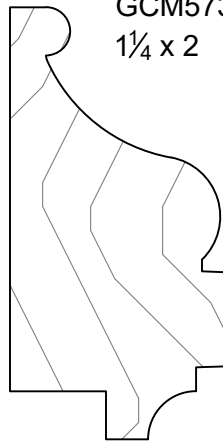

GCM5522  
1 1/8 X 2 1/4

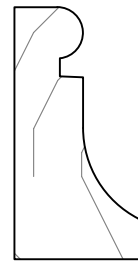

GCM2032  
1 1/16 X 1 5/16

# GRAYCO BUILDING CENTER

WWW.GRAYCOINC.COM

BLUFFTON  
345 BUCK ISLAND RD, BLUFFTON SC 29910  
(843) 815-5788 FAX 815-5799

LADY'S ISLAND  
20 SAMS POINT WAY, BEAUFORT SC 29907  
(843) 522-9994 FAX 522-9972

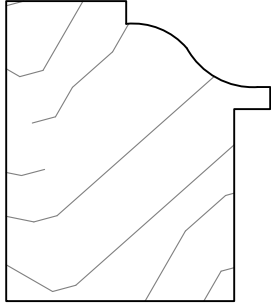

GCM8809  
VARIES X  $1\frac{3}{8}$

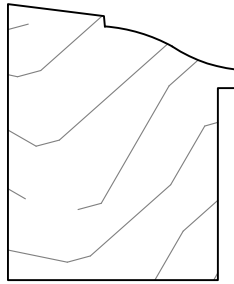

GCM284  
VARIES X  $1\frac{3}{16}$

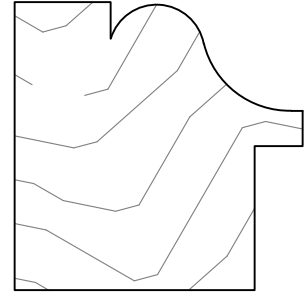

GCM313  
VARIES X  $1\frac{1}{2}$

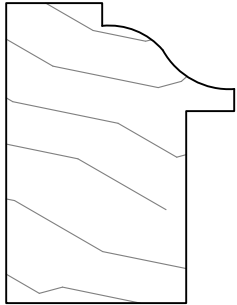

GCM1489  
VARIES X  $1\frac{3}{16}$

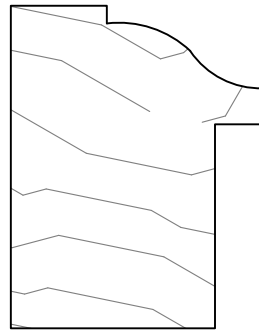

GCM17  
VARIES X  $1\frac{5}{16}$

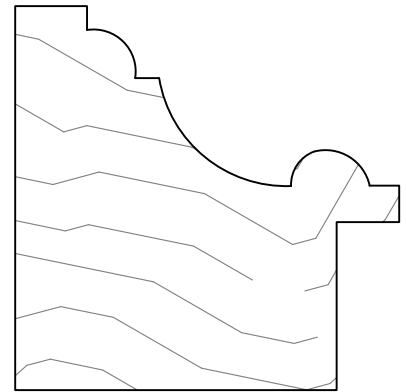

GCM628  
VARIES X 2

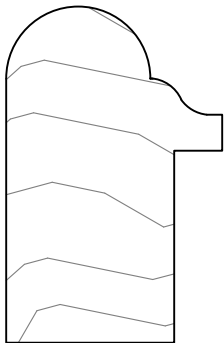

GCM434  
VARIES X  $1\frac{1}{8}$

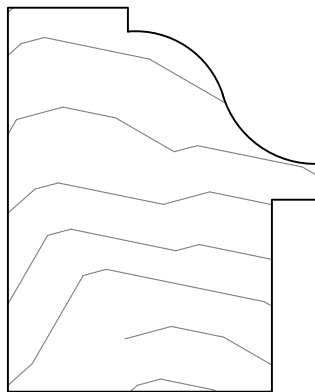

GCM427  
VARIES X  $1\frac{5}{8}$

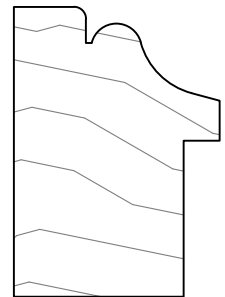

GCM50719  
VARIES X  $1\frac{1}{16}$

# GRAYCO BUILDING CENTER

WWW.GRAYCOINC.COM

BLUFFTON  
345 BUCK ISLAND RD, BLUFFTON SC 29910  
(843) 815-5788 FAX 815-5799

LADY'S ISLAND  
20 SAMS POINT WAY, BEAUFORT SC 29907  
(843) 522-9994 FAX 522-9972

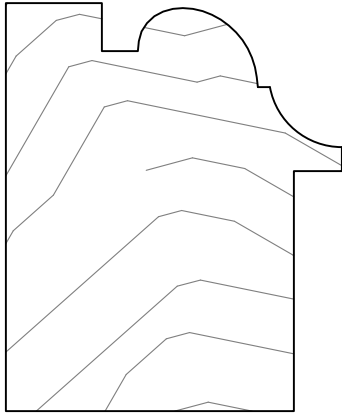

GCM1609  
VARIES X  $1\frac{3}{4}$

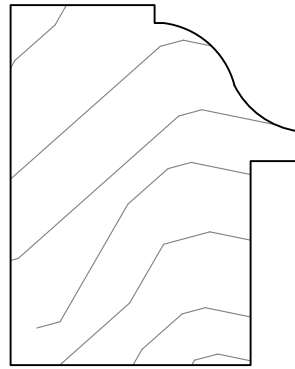

GCM280  
VARIES X  $1\frac{1}{2}$

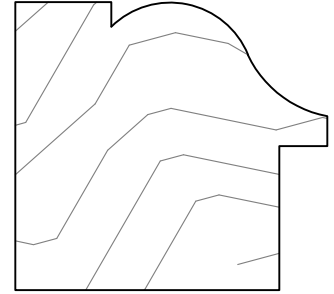

GCM730  
VARIES X  $1\frac{5}{8}$

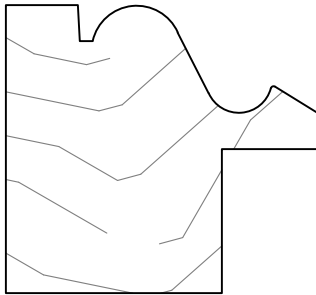

GCM158  
VARIES X  $1\frac{5}{8}$

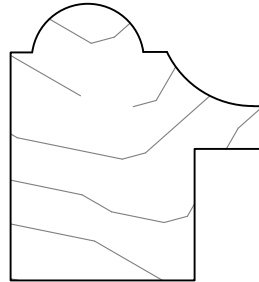

GCM511  
VARIES X  $1\frac{5}{16}$

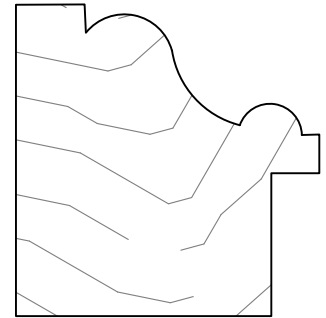

GCM510  
VARIES X  $1\frac{9}{16}$

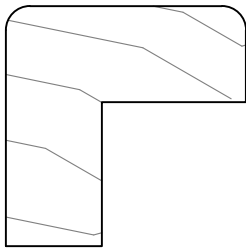

GCM64414  
 $1\frac{1}{4}$  X  $1\frac{1}{4}$

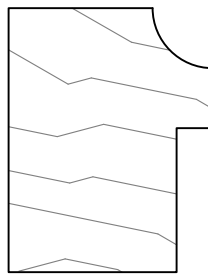

GCM84875  
VARIES X  $1\frac{1}{16}$

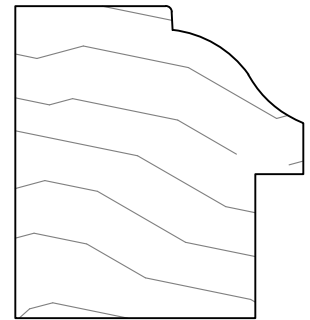

GCM84125  
VARIES X  $1\frac{1}{2}$

# GRAYCO BUILDING CENTER

WWW.GRAYCOINC.COM

BLUFFTON  
345 BUCK ISLAND RD, BLUFFTON SC 29910  
(843) 815-5788 FAX 815-5799

LADY'S ISLAND  
20 SAMS POINT WAY, BEAUFORT SC 29907  
(843) 522-9994 FAX 522-9972

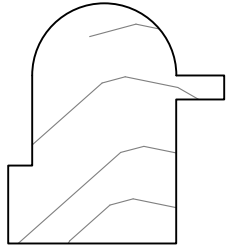

GCM513  
VARIES X  $1\frac{1}{8}$

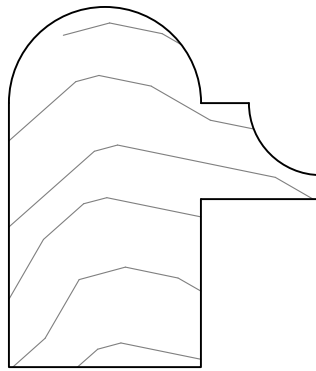

GCM2501  
VARIES X  $1\frac{5}{8}$

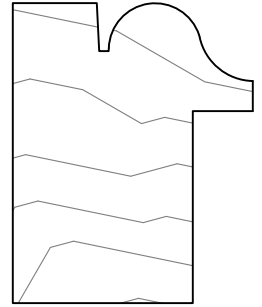

GCM2502  
VARIES X  $1\frac{1}{4}$

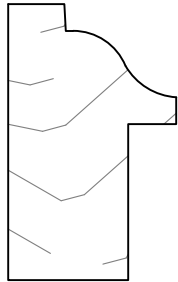

GCM2503  
VARIES X  $\frac{7}{8}$

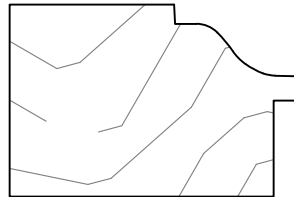

GCM2504  
VARIES X  $1\frac{1}{2}$

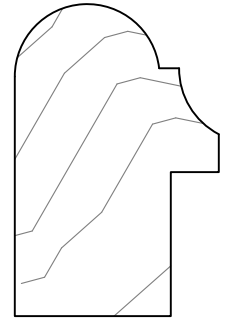

GCM289  
VARIES X  $1\frac{1}{16}$

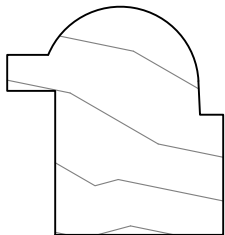

GCM1556  
VARIES X  $1\frac{1}{8}$



GCM64221  
VARIES X  $1\frac{1}{4}$

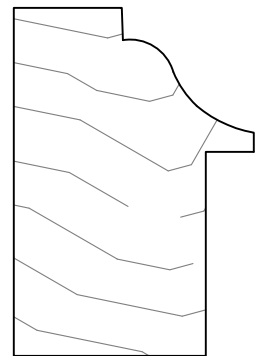

GCM2507  
VARIES X  $1\frac{1}{4}$

# GRAYCO BUILDING CENTER

WWW.GRAYCOINC.COM

BLUFFTON  
345 BUCK ISLAND RD, BLUFFTON SC 29910  
(843) 815-5788 FAX 815-5799

LADY'S ISLAND  
20 SAMS POINT WAY, BEAUFORT SC 29907  
(843) 522-9994 FAX 522-9972

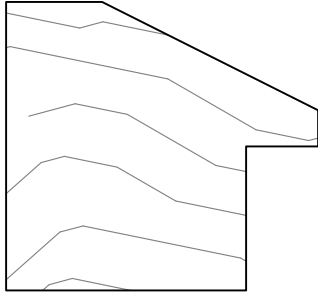

GCM2510  
VARIES X  $1\frac{5}{8}$

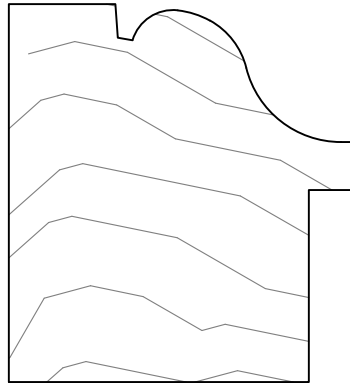

GCM15  
VARIES X  $1\frac{13}{16}$

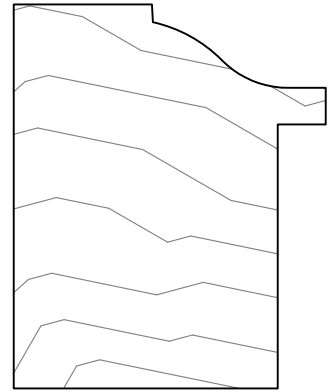

GCM2512  
VARIES X  $1\frac{5}{8}$

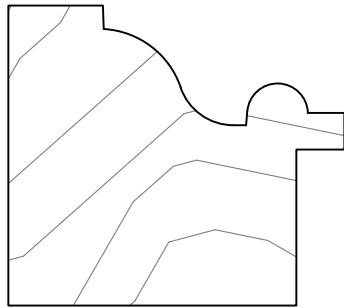

GCM946  
 $1\frac{9}{16}$  X  $1\frac{3}{4}$

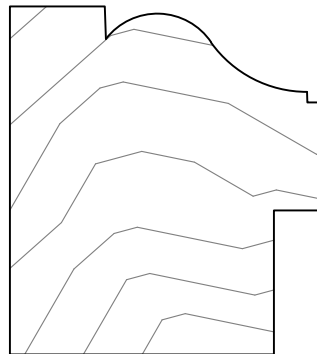

GCMDB-8 BB  
VARIES X  $1\frac{5}{8}$

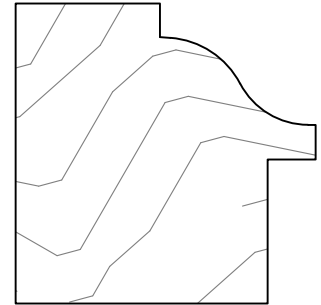

GCM18  
VARIES X  $1\frac{9}{16}$

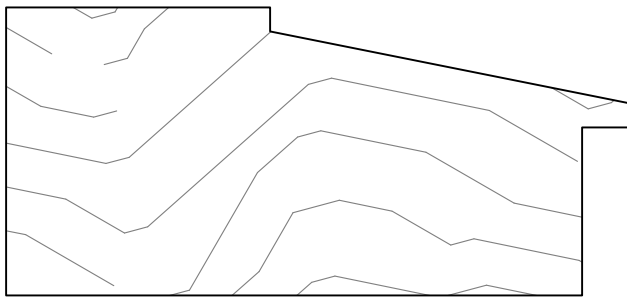

GCM1044  
VARIES X 3-1/4"

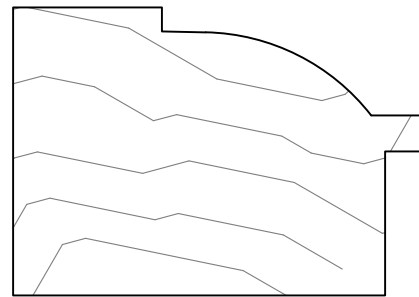

GCM2513  
VARIES X 2-1/8"

# GRAYCO BUILDING CENTER

WWW.GRAYCOINC.COM

BLUFFTON  
345 BUCK ISLAND RD, BLUFFTON SC 29910  
(843) 815-5788 FAX 815-5799

LADY'S ISLAND  
20 SAMS POINT WAY, BEAUFORT SC 29907  
(843) 522-9994 FAX 522-9972



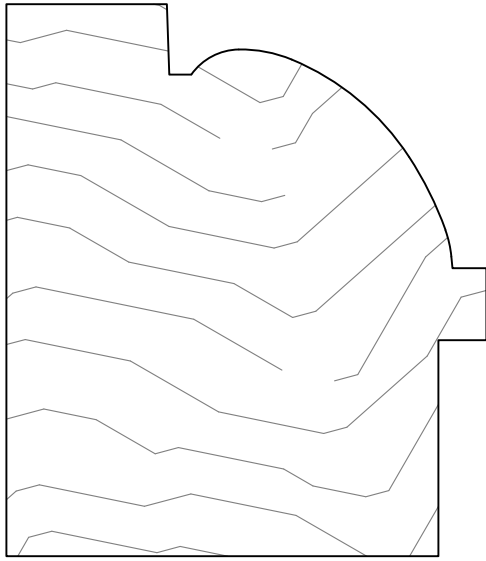

GCM2514  
2½ X VARIES

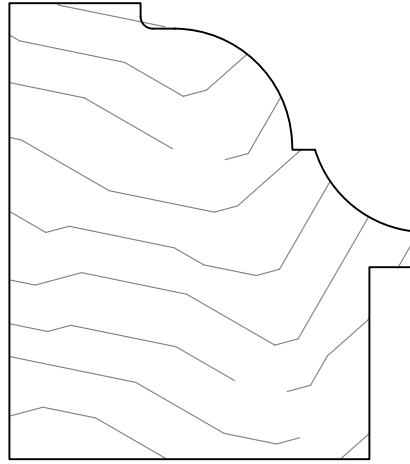

GCM1763  
VARIES X 2⅛

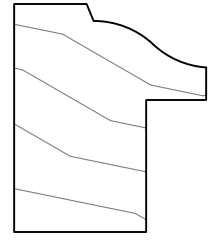

GCM2515  
1⅜ X 1

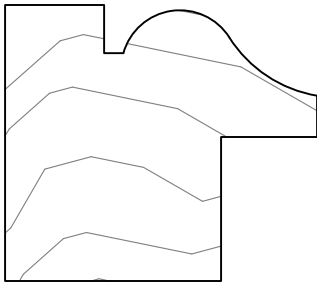

GCM2518  
VARIES X 1⅝

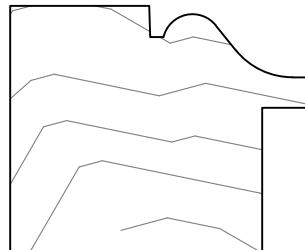

GCM2517  
VARIES X 1⅞"

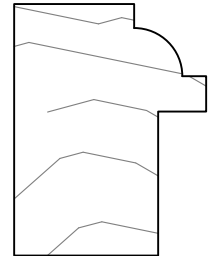

GCM2516  
VARIES X 1

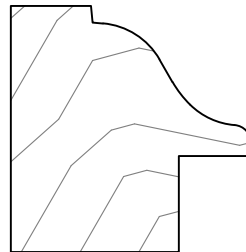

GCM2519  
VARIES X 1¼

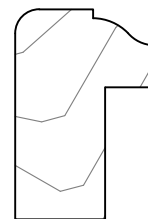

GCM281  
VARIES X 1⅛

# GRAYCO BUILDING CENTER

WWW.GRAYCOINC.COM

BLUFFTON  
345 BUCK ISLAND RD, BLUFFTON SC 29910  
(843) 815-5788 FAX 815-5799

LADY'S ISLAND  
20 SAMS POINT WAY, BEAUFORT SC 29907  
(843) 522-9994 FAX 522-9972

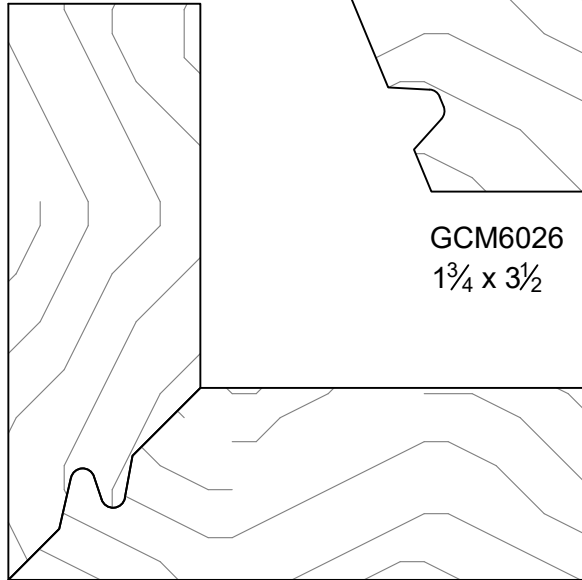

GCM 90 LM  
3/4 x VARIES

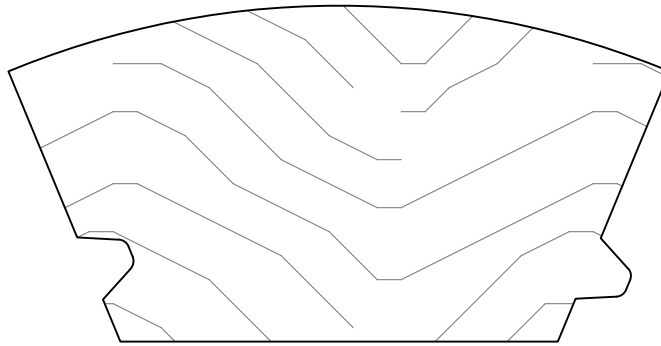

GCM6026  
1 3/4 x 3 1/2



GCM6022  
3/4 X 3 1/2

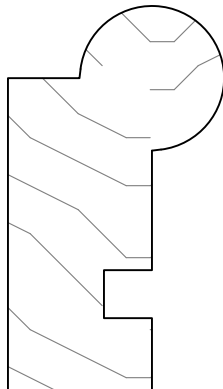

GCM6009  
1 1/8 x 2

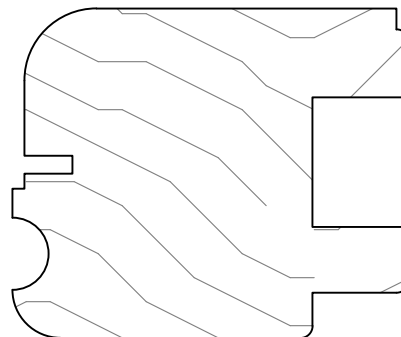

GCM6006  
1 3/4 x 2 1/16

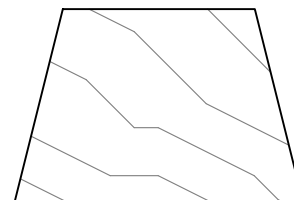

GCM759  
1 X 1 1/2

# GRAYCO BUILDING CENTER

WWW.GRAYCOINC.COM

BLUFFTON  
345 BUCK ISLAND RD, BLUFFTON SC 29910  
(843) 815-5788 FAX 815-5799

LADY'S ISLAND  
20 SAMS POINT WAY, BEAUFORT SC 29907  
(843) 522-9994 FAX 522-9972

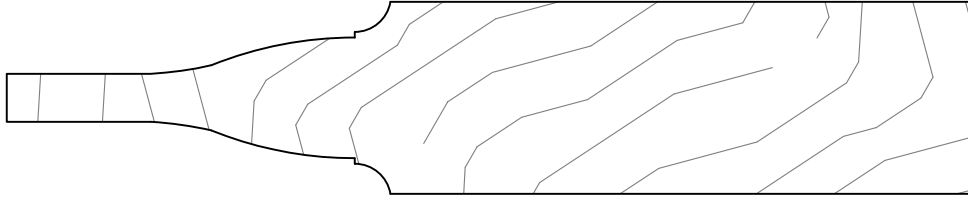

GCM 9522

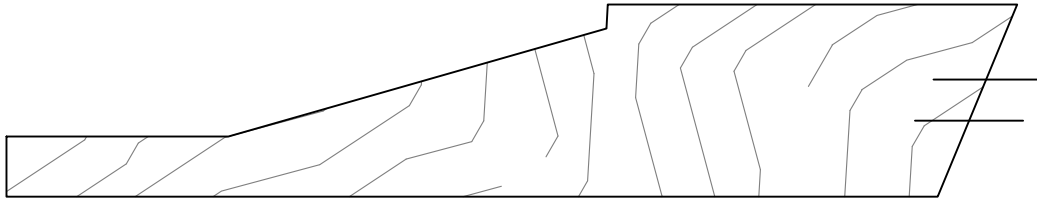

GCM6013  
1 x VARIES

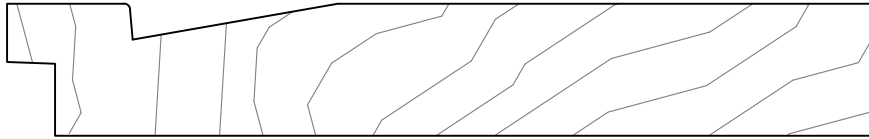

GCM ANDERSEN JAMB EXTENSION

$1\frac{1}{16}$  x  $4\frac{9}{16}$ ,  $6\frac{9}{16}$ ,  $7\frac{1}{8}$

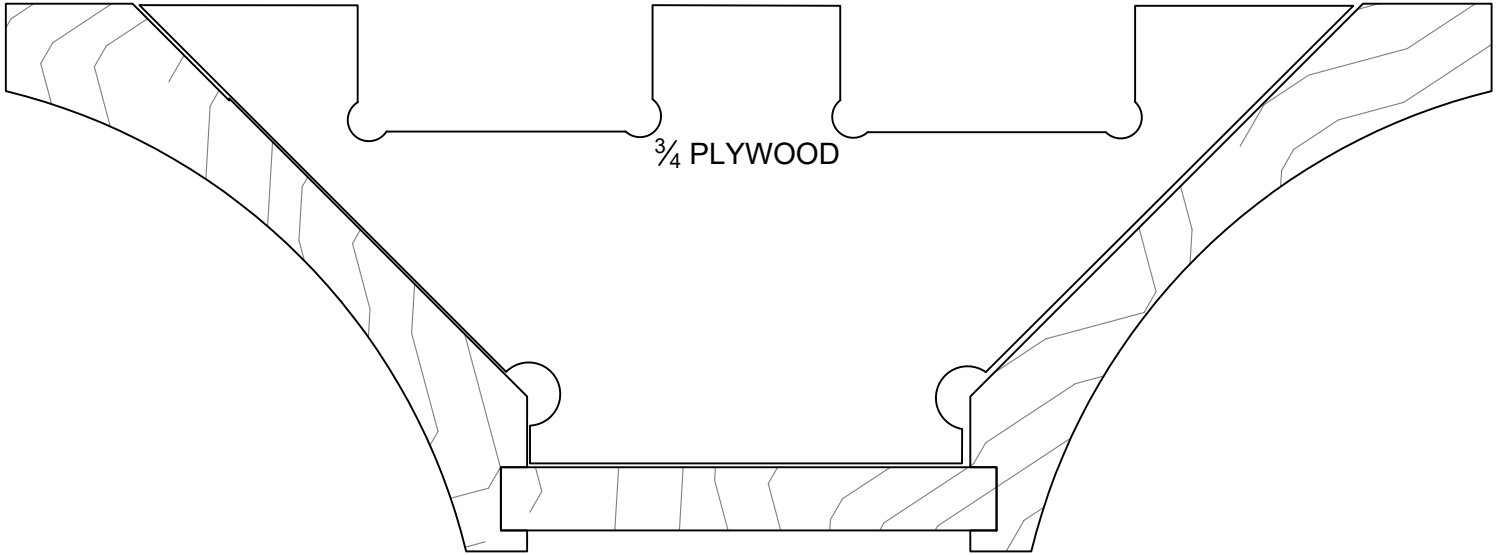

CUSTOM CROWN TRUSSES, MADE  
TO ORDER

# GRAYCO BUILDING CENTER

WWW.GRAYCOINC.COM

BLUFFTON  
345 BUCK ISLAND RD, BLUFFTON SC 29910  
(843) 815-5788 FAX 815-5799

LADY'S ISLAND  
20 SAMS POINT WAY, BEAUFORT SC 29907  
(843) 522-9994 FAX 522-9972



GCM PARTING BEAD  
 $\frac{3}{8} \times 1\frac{3}{16}$

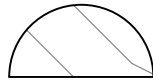

GCM3003  
 $\frac{3}{8} \times \frac{3}{4}$

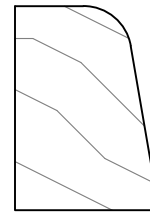

GCM807  
 $\frac{3}{4} \times 1\frac{1}{16}$

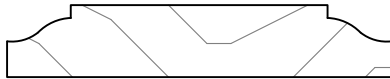

GCM985  
 $\frac{3}{8} \times 2$

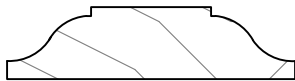

GCM988  
 $\frac{3}{8} \times 1\frac{1}{2}$

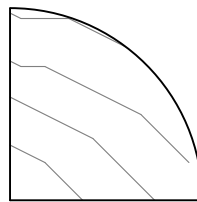

GCM3002  
1 x 1

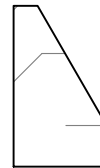

GCM8501  
 $\frac{1}{2} \times 1\frac{13}{16}$ "

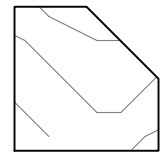

GCM6053  
 $\frac{3}{4} \times \frac{3}{4}$

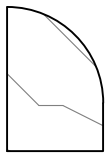

GCM129  
 $\frac{1}{2} \times \frac{3}{4}$

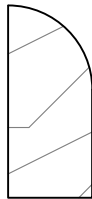

GCM8502  
 $\frac{7}{16} \times 1$

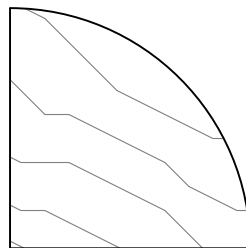

GCM3001  
 $1\frac{1}{4} \times 1\frac{1}{4}$



GCM8009  
 $\frac{3}{8} \times 1\frac{1}{8}$

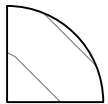

GCM108  
 $\frac{1}{2} \times \frac{1}{2}$



GCM8503  
 $\frac{1}{2} \times 1$

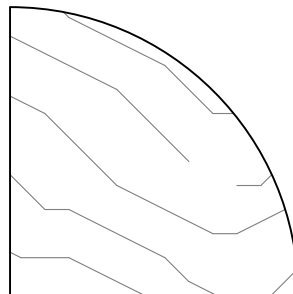

GCM3007  
 $1\frac{1}{2} \times 1\frac{1}{2}$

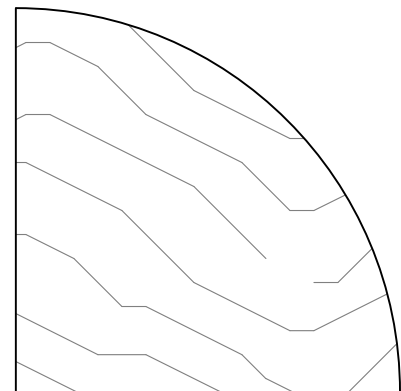

GCM3008  
2" X 2"

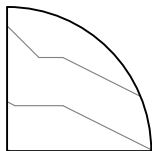

GCM105  
 $\frac{3}{4} \times \frac{3}{4}$

# GRAYCO BUILDING CENTER

WWW.GRAYCOINC.COM

BLUFFTON  
345 BUCK ISLAND RD, BLUFFTON SC 29910  
(843) 815-5788 FAX 815-5799

LADY'S ISLAND  
20 SAMS POINT WAY, BEAUFORT SC 29907  
(843) 522-9994 FAX 522-9972

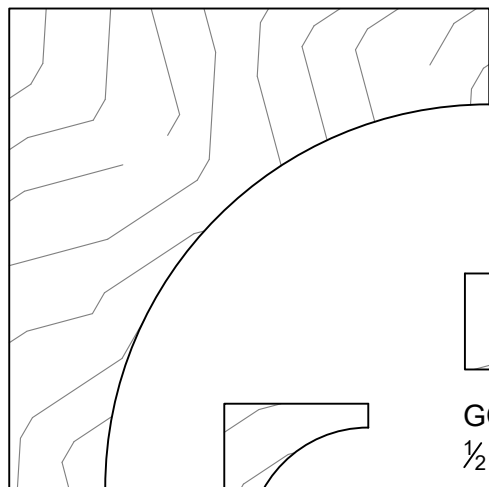

GCM6005  
2½ x 2½

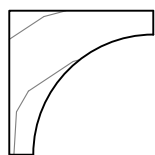

GCM6047  
¾ x ¾

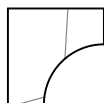

GCM6015  
½ x ½

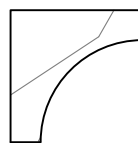

GCM100  
1¼ x 1¼

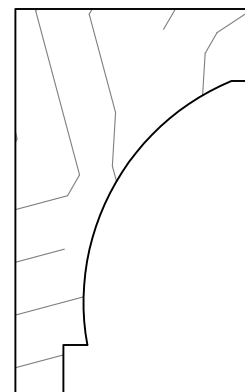

GCM6045  
1¼ x 2"

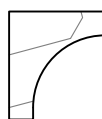

GCM6017  
½ x 9/16

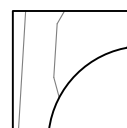

GCM6016  
5/8 x 5/8

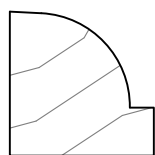

GCM3006  
¾ x ¾"

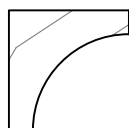

GCM97  
5/8 x 5/8



GCM6046  
½ x ½

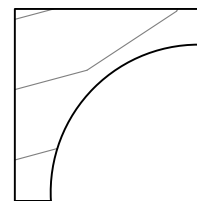

GCM101  
1 x 1

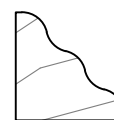

GCM5517  
9/16 x 9/16

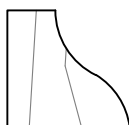

GCM607  
5/8 x 5/8



GCM99  
¾ x ½

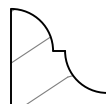

GCM6012  
½ x ½



GCM6011  
7/16 x ½

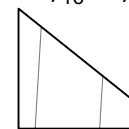

GCM6048  
5/8 x 5/8



GCM3004  
3/8 x 3/8



GCM6033  
½ x ¾"



GCM819  
½ x 1



GCM451  
5/8 x 1

# GRAYCO BUILDING CENTER

WWW.GRAYCOINC.COM

BLUFFTON  
345 BUCK ISLAND RD, BLUFFTON SC 29910  
(843) 815-5788 FAX 815-5799

LADY'S ISLAND  
20 SAMS POINT WAY, BEAUFORT SC 29907  
(843) 522-9994 FAX 522-9972

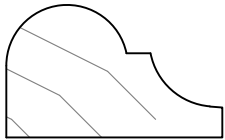

GCM6058  
1 1/16 X 1 1/8

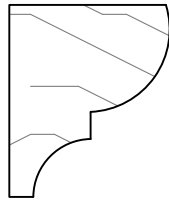

GCM6061  
1 3/16 X 1"

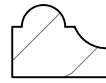

GCM8007  
3/8 X 1/2

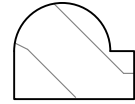

GCM5510  
1/2 X 5/8

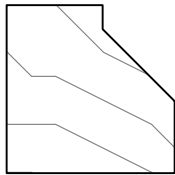

GCM9550  
7/8 X 7/8

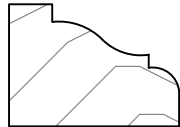

GCM195  
5/8 X 7/8

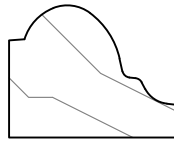

GCM6065  
1 1/16 X 7/8

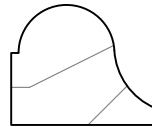

GCM6051  
5/8 X 3/4



GCM987  
3/8 X 1/2



GCM604  
3/8 X 9/16

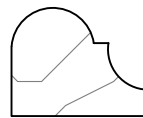

GCM173  
5/8 X 3/4

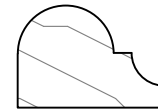

GCM1061  
1 7/32 X 3/4

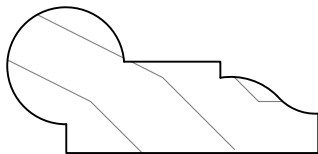

GCM273  
3/4 X 1 5/8

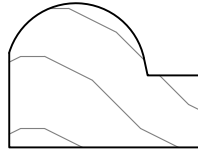

GCM6057  
3/4 X 1

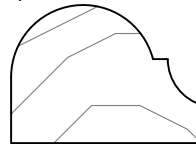

GCM4175  
3/4 X 1

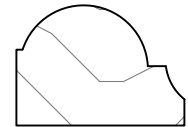

GCM6055  
5/8 X 7/8

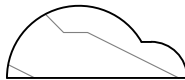

GCM6029  
3/8 X 1 5/16

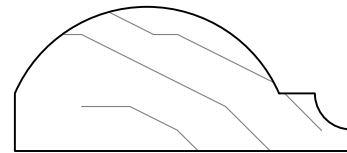

GCM6027  
3/4 X 1 3/4

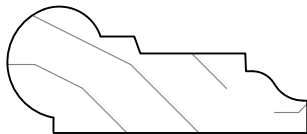

GCM9026  
1 1/16 X 1 9/16



GCM6028  
1 X 1 1/4

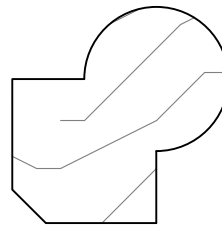

GCM972  
1 1/8 X 1 1/8

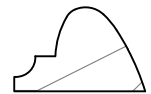

GCM40068  
7/16 X 1 1/16"

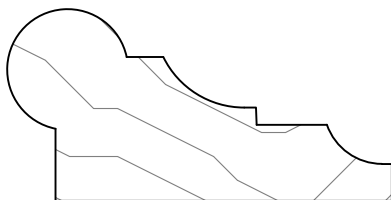

GCM1414  
1 X 2"

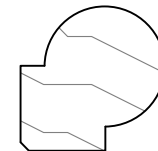

GCM231  
3/4 X 3/4

# GRAYCO BUILDING CENTER

WWW.GRAYCOINC.COM

BLUFFTON  
345 BUCK ISLAND RD, BLUFFTON SC 29910  
(843) 815-5788 FAX 815-5799

LADY'S ISLAND  
20 SAMS POINT WAY, BEAUFORT SC 29907  
(843) 522-9994 FAX 522-9972

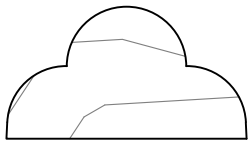

GCM8142  
1 1/16 X 1 1/4



GCM5506  
1 1/4 X 2 1/4"

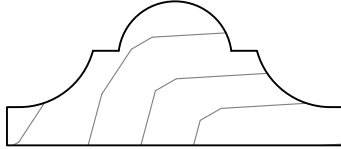

GCM1063  
3/4 X 1 3/4

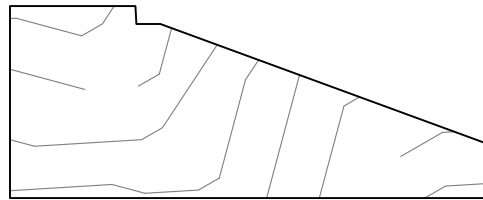

GCM6508  
1 X 2 1/2"

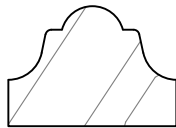

GCM1064  
5/8 X 7/8



GCM989  
3/8 x VARIES

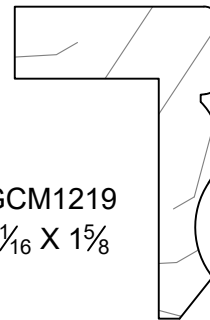

GCM1219  
1 1/16 X 1 5/8

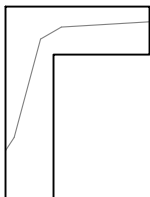

GCM7011  
9/16 X 2 1/2



3/4 X 1 CORNER TRIM



GCM955  
3/8 x VARIES

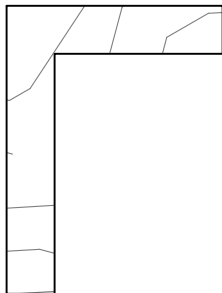

1 1/8 X 1 1/2" CORNER TRIM



GCM7004  
7/16 X 3 5/16"

# GRAYCO BUILDING CENTER

WWW.GRAYCOINC.COM

BLUFFTON  
345 BUCK ISLAND RD, BLUFFTON SC 29910  
(843) 815-5788 FAX 815-5799

LADY'S ISLAND  
20 SAMS POINT WAY, BEAUFORT SC 29907  
(843) 522-9994 FAX 522-9972

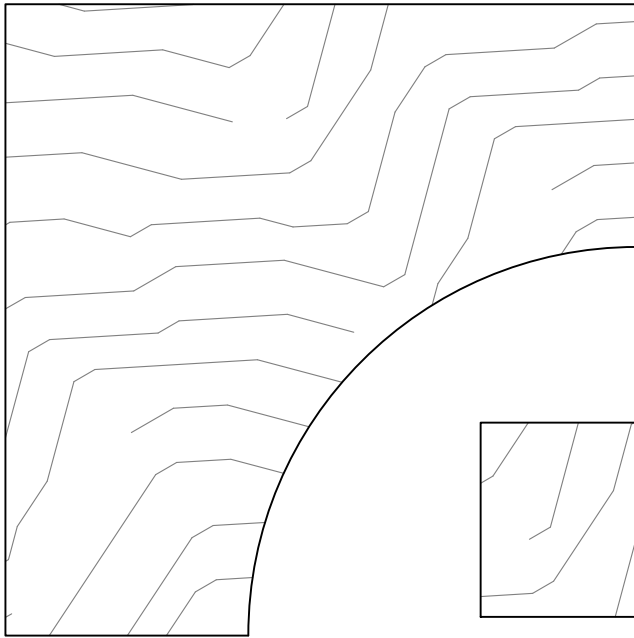

GCM8012  
3¼ X 3¼

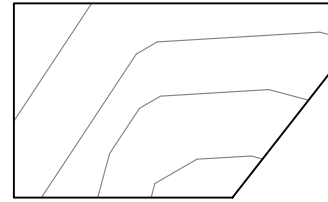

GCM6059  
1⅝ X 1

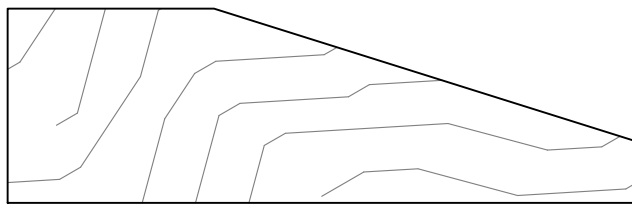

GCM6008  
1 X 3½

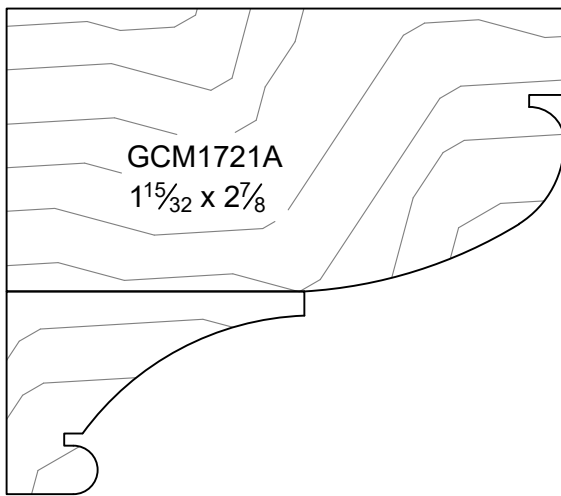

GCM1721A  
1⅝<sub>32</sub> X 2⅞

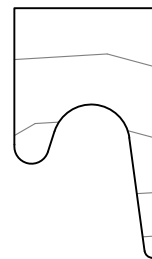

GCM6036 DOOR PULL  
¾ X 1¼"

GCM1721B  
1⅓<sub>32</sub> X 1⅞<sub>32</sub>

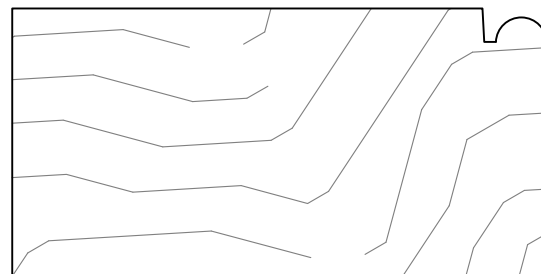

GCM1029  
1⅜ X 2¾"

# GRAYCO BUILDING CENTER

WWW.GRAYCOINC.COM

BLUFFTON  
345 BUCK ISLAND RD, BLUFFTON SC 29910  
(843) 815-5788 FAX 815-5799

LADY'S ISLAND  
20 SAMS POINT WAY, BEAUFORT SC 29907  
(843) 522-9994 FAX 522-9972



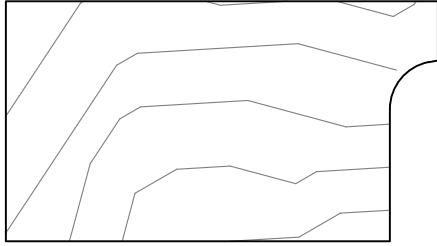

GCM6030  
1¼ x 2¼



GCM5508  
¾ x 1½"



GCM6052  
½ x 1

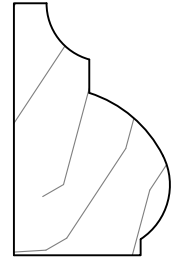

GCM5507  
1⅜ x 1⅝"

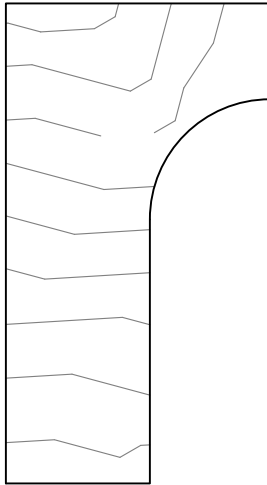

GCM6031  
1⅜ x 2½

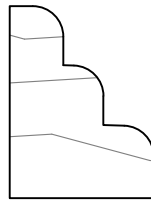

GCM2022  
¾ x 1



GCM1042  
1½ x 2¼

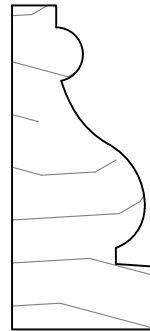

GCM5509  
¾ x 1⅞"

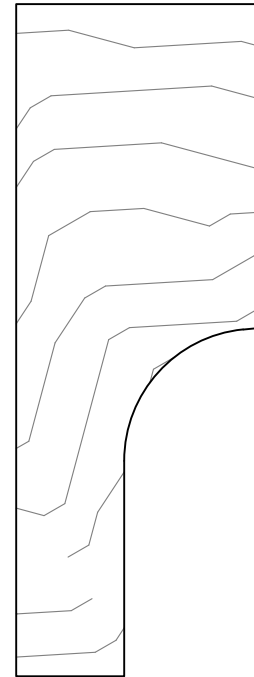

GCM6040  
1¼ x 3½

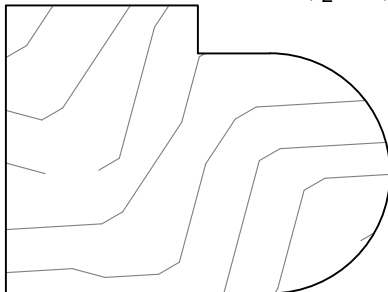

GCM1438  
1½ x 2

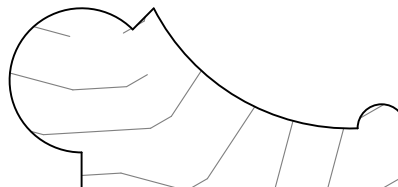

GCM675  
1⅝ x 2¼"

# GRAYCO BUILDING CENTER

WWW.GRAYCOINC.COM

BLUFFTON  
345 BUCK ISLAND RD, BLUFFTON SC 29910  
(843) 815-5788 FAX 815-5799

LADY'S ISLAND  
20 SAMS POINT WAY, BEAUFORT SC 29907  
(843) 522-9994 FAX 522-9972

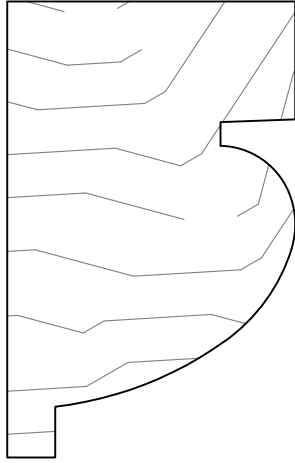

GCM586  
1½ X 2¾



GCM588  
2¼ X 2¾

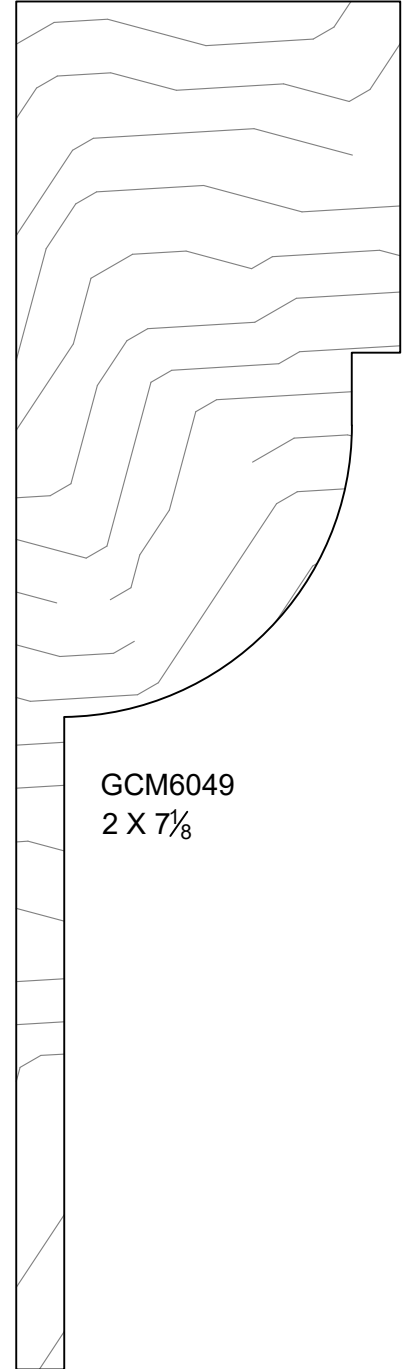

GCM6049  
2 X 7⅞

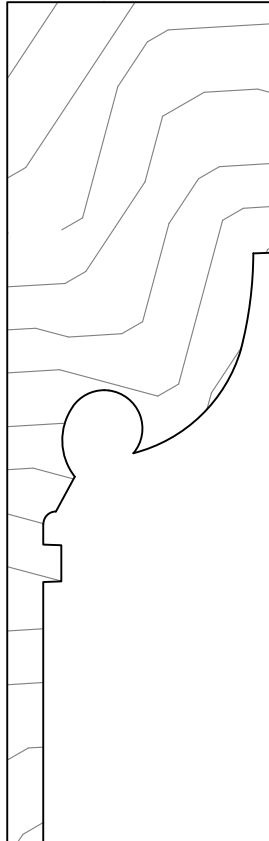

GCM8250  
1⅜ X 4⅜

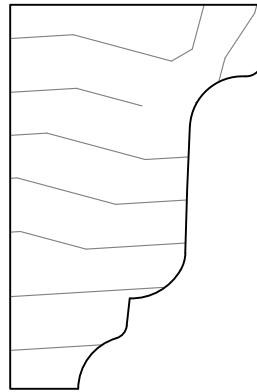

GCM8252  
1⅝ X 2

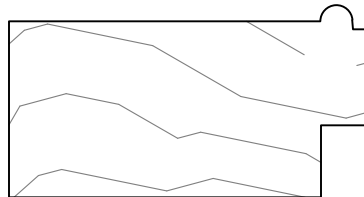

GCM1180  
1 X 1⅞

# GRAYCO BUILDING CENTER

WWW.GRAYCOINC.COM

BLUFFTON  
345 BUCK ISLAND RD, BLUFFTON SC 29910  
(843) 815-5788 FAX 815-5799

LADY'S ISLAND  
20 SAMS POINT WAY, BEAUFORT SC 29907  
(843) 522-9994 FAX 522-9972

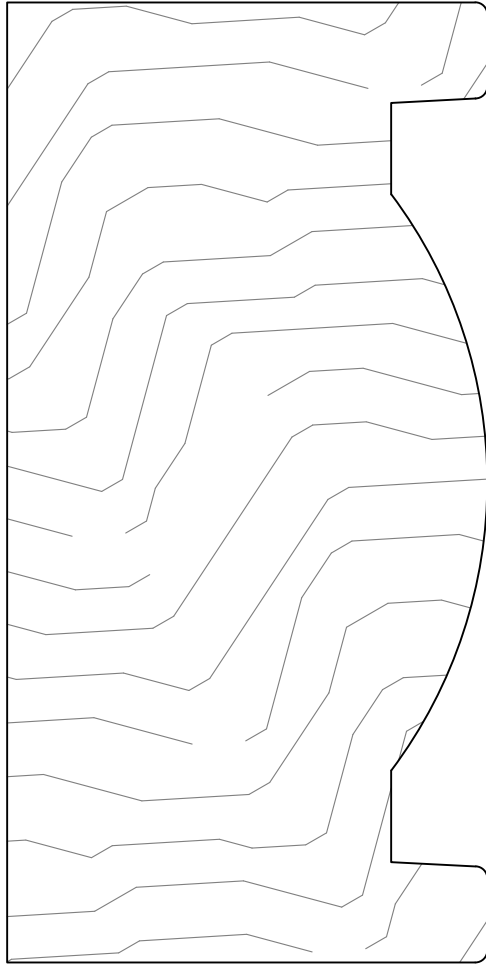

GCM1014  
2½ x 5

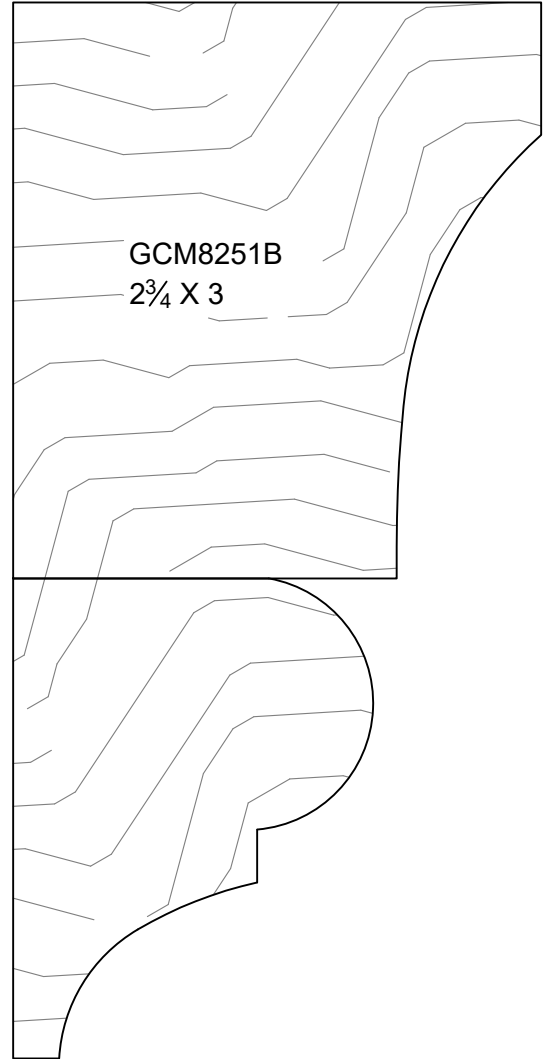

GCM8251B  
2¾ X 3

GCM8251A  
1⅞ X 2½

## GRAYCO BUILDING CENTER

WWW.GRAYCOINC.COM

BLUFFTON  
345 BUCK ISLAND RD, BLUFFTON SC 29910  
(843) 815-5788 FAX 815-5799

LADY'S ISLAND  
20 SAMS POINT WAY, BEAUFORT SC 29907  
(843) 522-9994 FAX 522-9972

GCM8014A

$1\frac{3}{16} \times 2\frac{1}{4}$

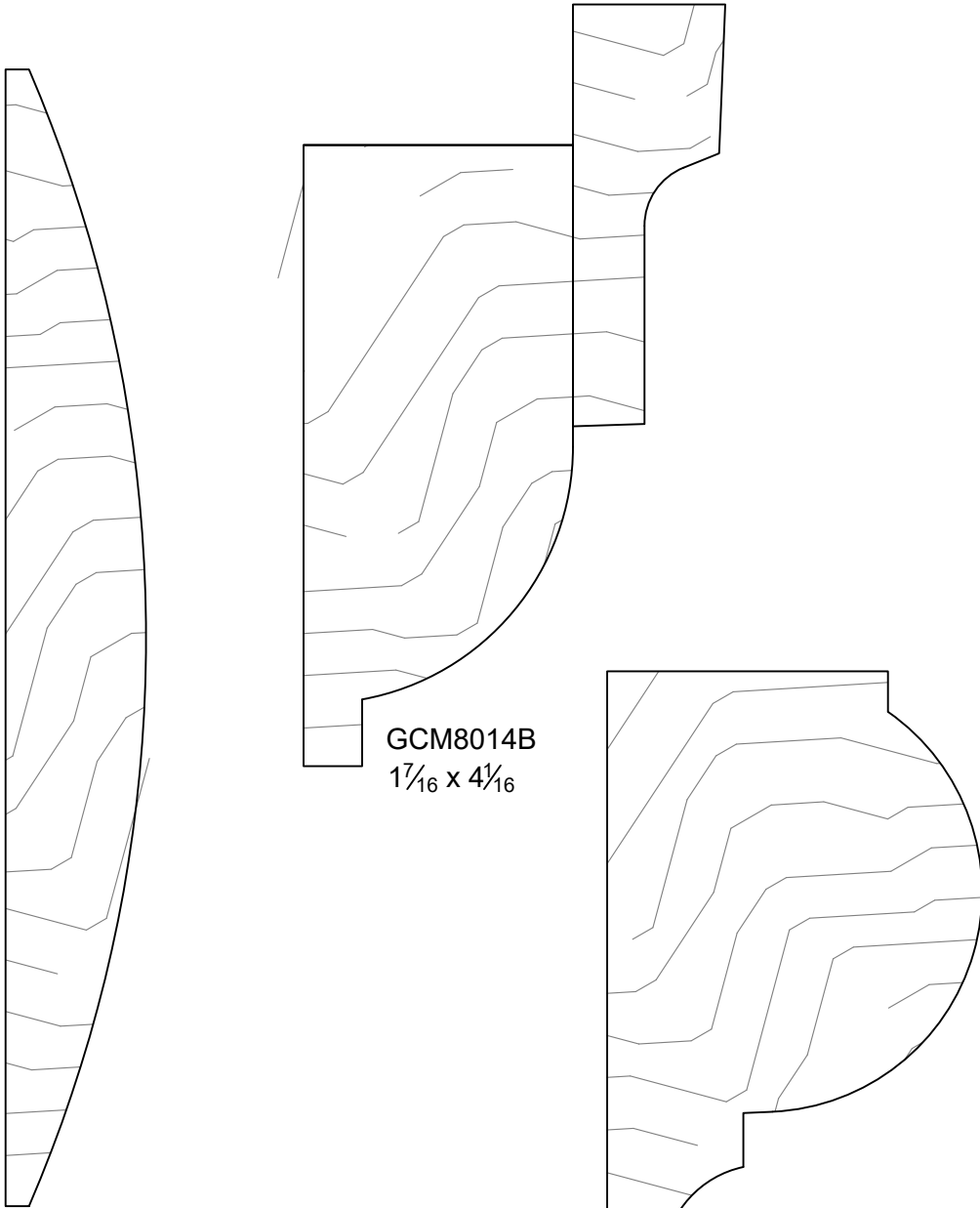

GCM8013

$\frac{3}{4} \times 6\frac{1}{16}$

GCM8014B

$1\frac{7}{16} \times 4\frac{1}{16}$

GCM8016

$2 \times 3\frac{1}{4}$

# GRAYCO BUILDING CENTER

[WWW.GRAYCOINC.COM](http://WWW.GRAYCOINC.COM)

BLUFFTON  
345 BUCK ISLAND RD, BLUFFTON SC 29910  
(843) 815-5788 FAX 815-5799

LADY'S ISLAND  
20 SAMS POINT WAY, BEAUFORT SC 29907  
(843) 522-9994 FAX 522-9972

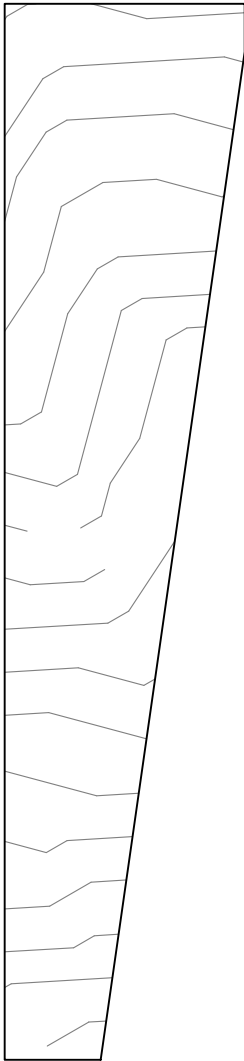

GCM8017  
1¼ X 5½

## GRAYCO BUILDING CENTER

[WWW.GRAYCOINC.COM](http://WWW.GRAYCOINC.COM)

BLUFFTON  
345 BUCK ISLAND RD, BLUFFTON SC 29910  
(843) 815-5788 FAX 815-5799

LADY'S ISLAND  
20 SAMS POINT WAY, BEAUFORT SC 29907  
(843) 522-9994 FAX 522-9972

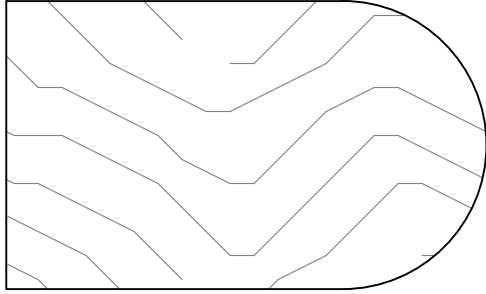

GCM6510  
1½ X VARIES

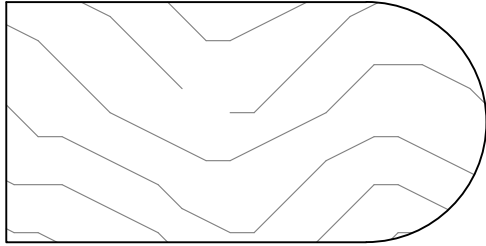

GCM6509  
1¼ X VARIES

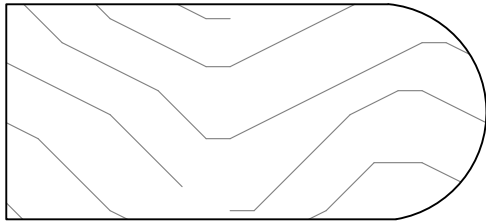

GCM1185  
1⅛ X VARIES

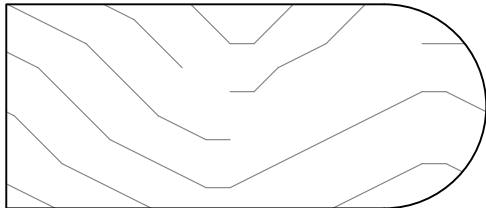

GCM6501  
1⅙ X VARIES

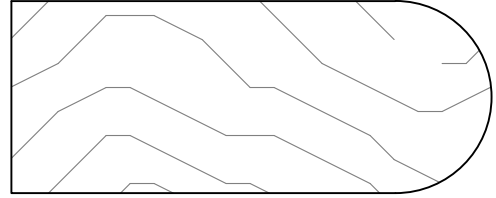

GCM6505  
1 X VARIES

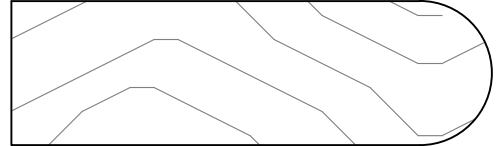

GCM6504  
¾ X VARIES

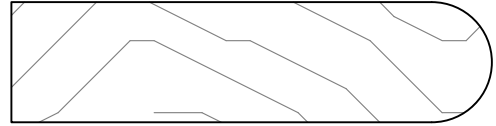

GCM6506  
⅝ X VARIES

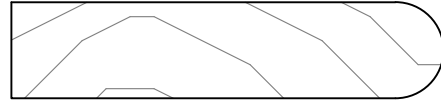

GCM6502  
½ X VARIES

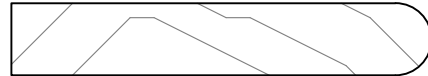

GCM6503  
⅜ X VARIES

# GRAYCO BUILDING CENTER

WWW.GRAYCOINC.COM

BLUFFTON  
345 BUCK ISLAND RD, BLUFFTON SC 29910  
(843) 815-5788 FAX 815-5799

LADY'S ISLAND  
20 SAMS POINT WAY, BEAUFORT SC 29907  
(843) 522-9994 FAX 522-9972

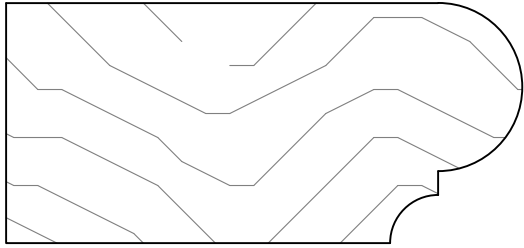

GCM673  
1¼ x VARIES

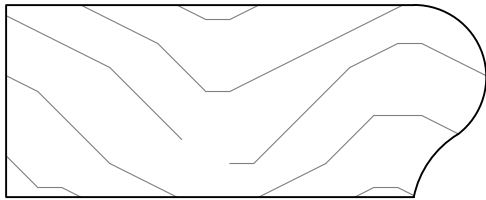

GCM1102  
1 x VARIES

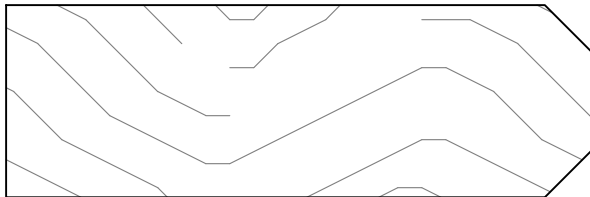

GCM2505  
1" X VARIES

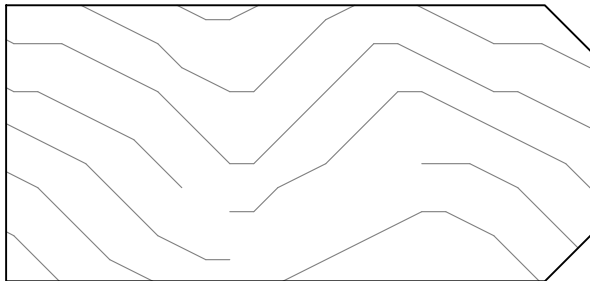

GCM2506  
1<sup>7</sup>/<sub>16</sub> X VARIES

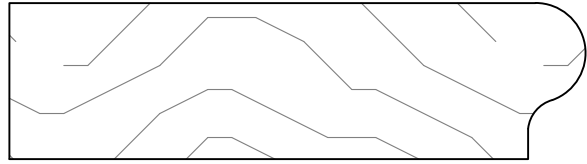

GCM1195  
1<sup>3</sup>/<sub>16</sub> X 3"

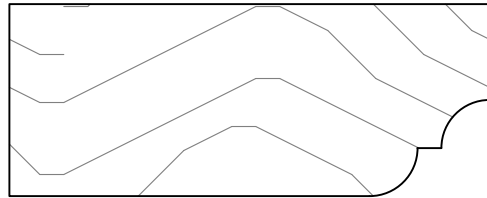

GCM6507  
1 X 2½"

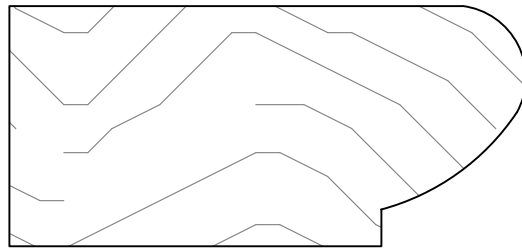

GCM1176  
1¼ x VARIES

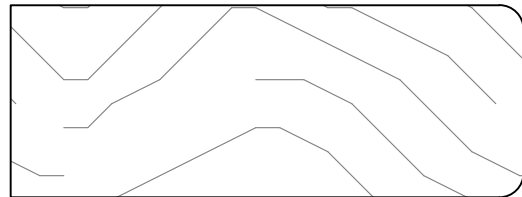

GCM8006  
1 X VARIES

# GRAYCO BUILDING CENTER

WWW.GRAYCOINC.COM

BLUFFTON  
345 BUCK ISLAND RD, BLUFFTON SC 29910  
(843) 815-5788 FAX 815-5799

LADY'S ISLAND  
20 SAMS POINT WAY, BEAUFORT SC 29907  
(843) 522-9994 FAX 522-9972

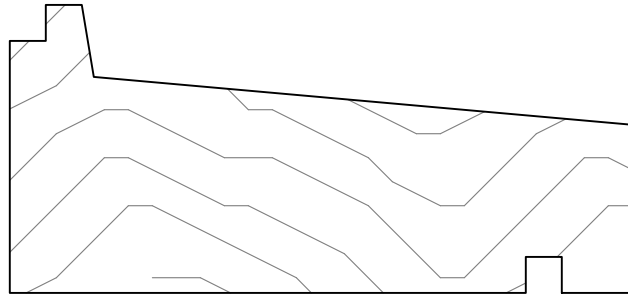

GCM6511  
1½ X ¾

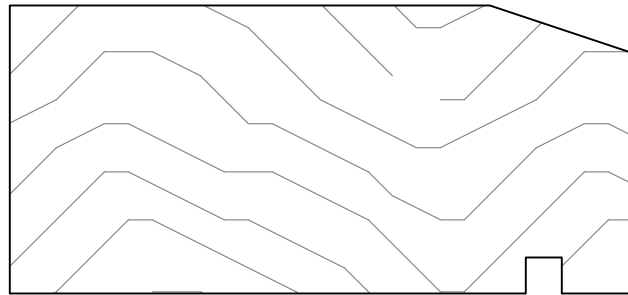

GCM6512  
1½ X ¾

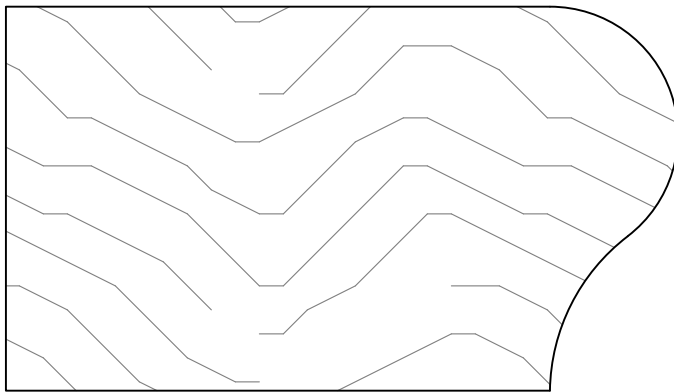

GCM6514  
2 X VARIES

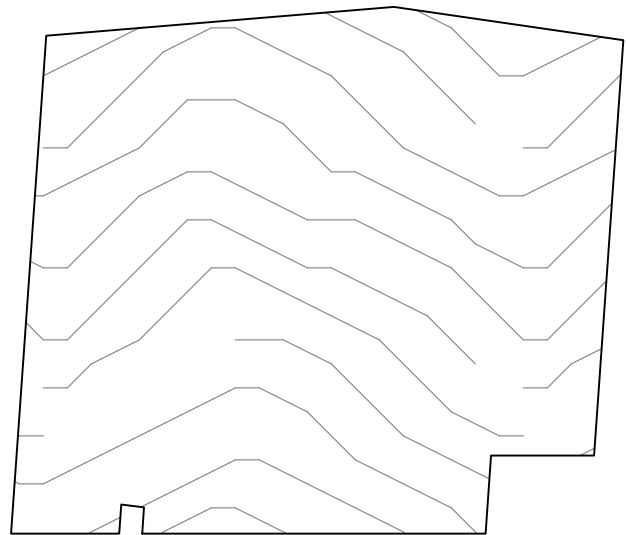

GCM6513  
3" X 3"

# GRAYCO BUILDING CENTER

WWW.GRAYCOINC.COM

BLUFFTON  
345 BUCK ISLAND RD, BLUFFTON SC 29910  
(843) 815-5788 FAX 815-5799

LADY'S ISLAND  
20 SAMS POINT WAY, BEAUFORT SC 29907  
(843) 522-9994 FAX 522-9972



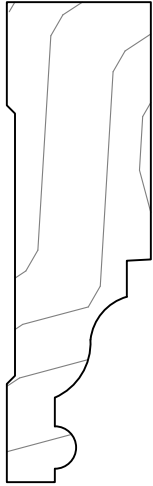

GCM2  
3/4 x VARIES

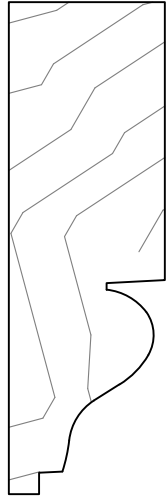

GCM4004  
13/16 X 2 9/16"

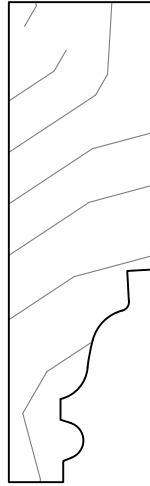

GCM4001  
3/4 X 2 1/2

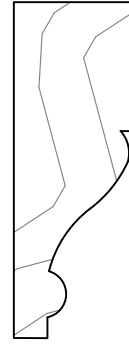

GCM220  
5/8 x 1 3/4

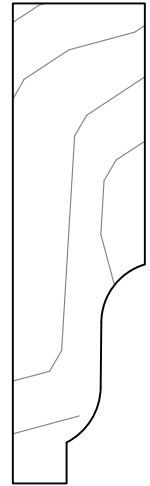

GCM207  
1/16 X 2 1/2

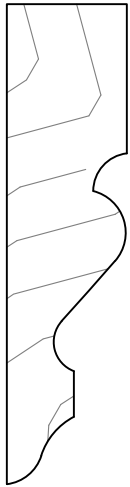

GCM212  
5/8 X 2 1/2



GCM1150  
13/16 X 3 1/2



GCM6064  
5/8 X 1 7/8



GCM8020  
1/16 X 2 1/4

# GRAYCO BUILDING CENTER

WWW.GRAYCOINC.COM

BLUFFTON  
345 BUCK ISLAND RD, BLUFFTON SC 29910  
(843) 815-5788 FAX 815-5799

LADY'S ISLAND  
20 SAMS POINT WAY, BEAUFORT SC 29907  
(843) 522-9994 FAX 522-9972

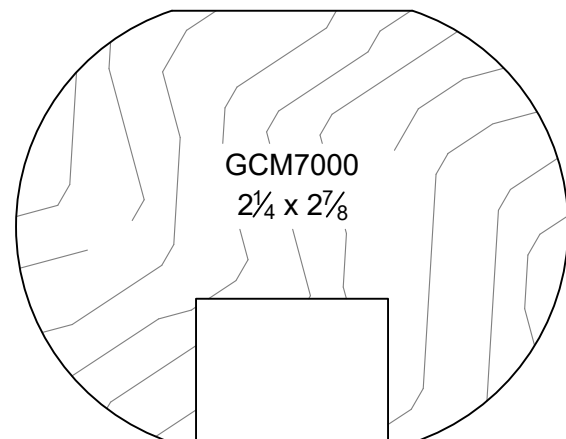
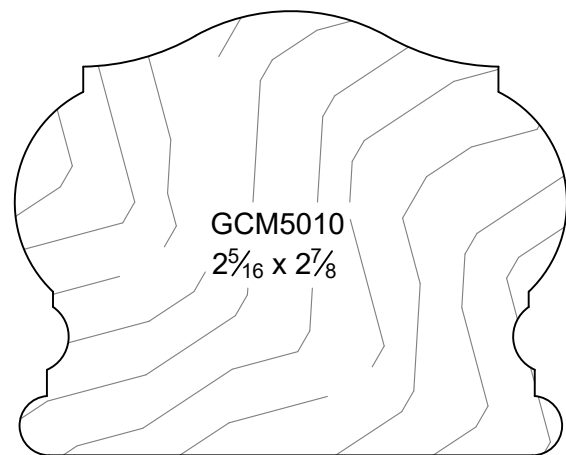
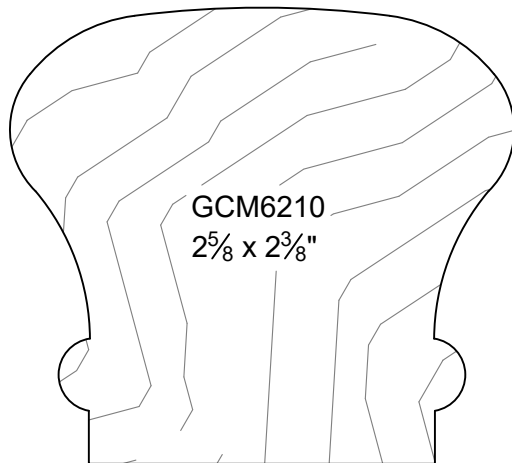
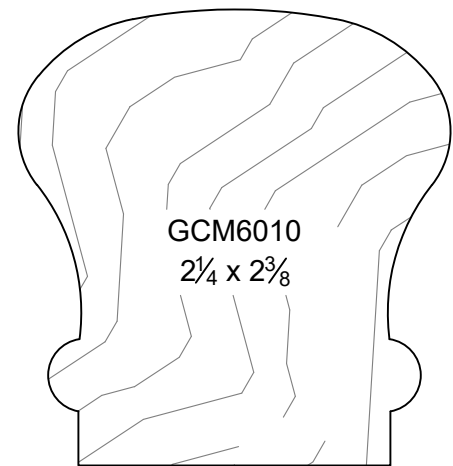
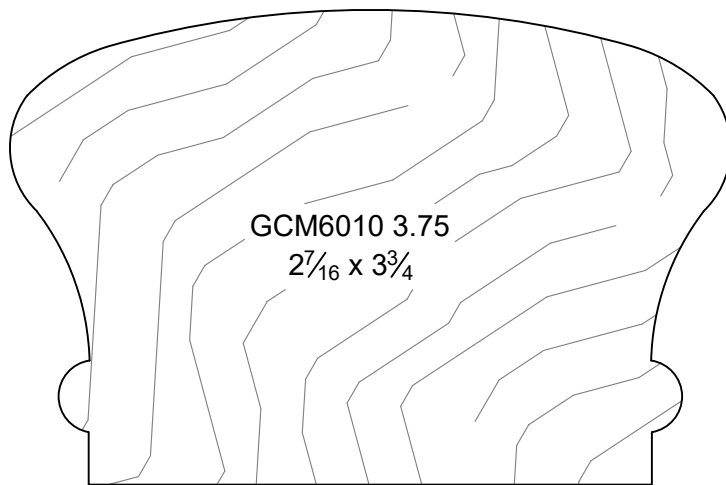

# GRAYCO BUILDING CENTER

WWW.GRAYCOINC.COM

BLUFFTON  
345 BUCK ISLAND RD, BLUFFTON SC 29910  
(843) 815-5788 FAX 815-5799

LADY'S ISLAND  
20 SAMS POINT WAY, BEAUFORT SC 29907  
(843) 522-9994 FAX 522-9972

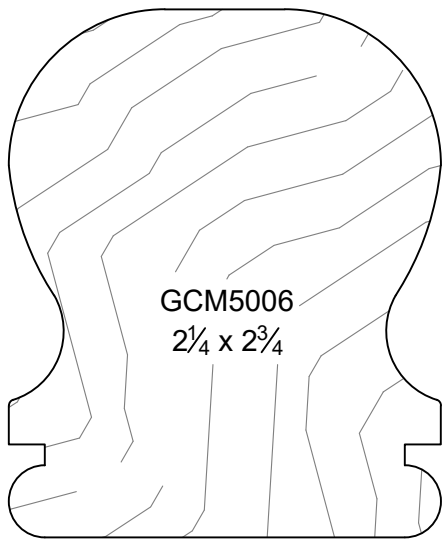

GCM5006  
2¼ x 2¾

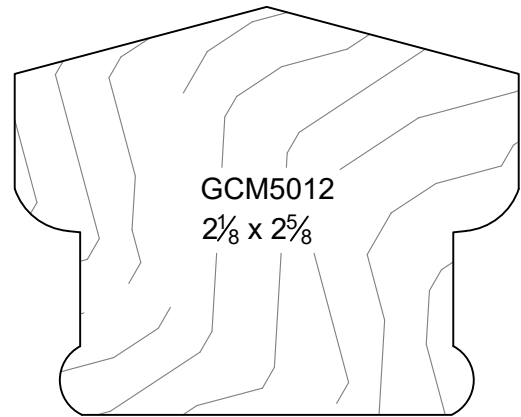

GCM5012  
2⅛ x 2⅝

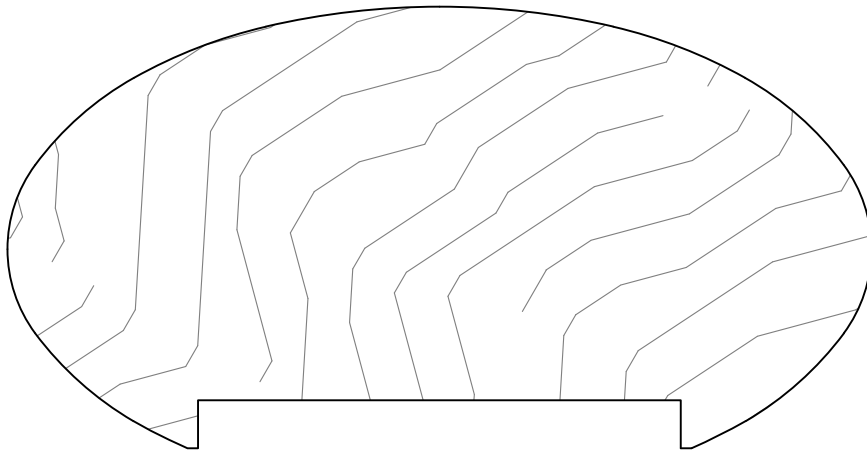

GCM5034  
2⅝ X 4½

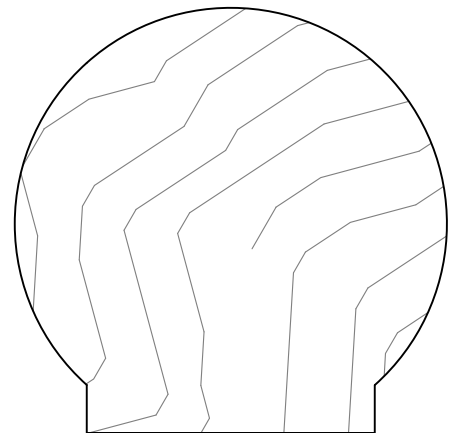

GCM5007  
2¼ DIA

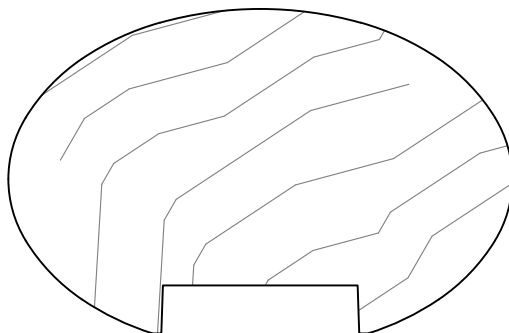

GCM5037  
1⅛ X 2⅝

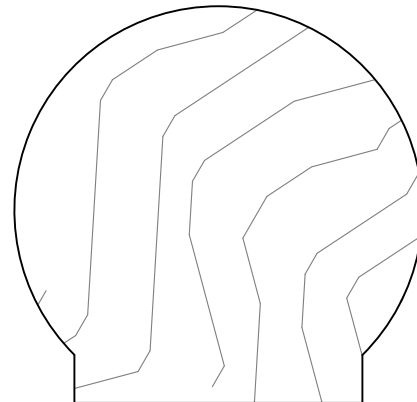

GCM5032  
2⅛ DIA

# GRAYCO BUILDING CENTER

WWW.GRAYCOINC.COM

BLUFFTON  
345 BUCK ISLAND RD, BLUFFTON SC 29910  
(843) 815-5788 FAX 815-5799

LADY'S ISLAND  
20 SAMS POINT WAY, BEAUFORT SC 29907  
(843) 522-9994 FAX 522-9972

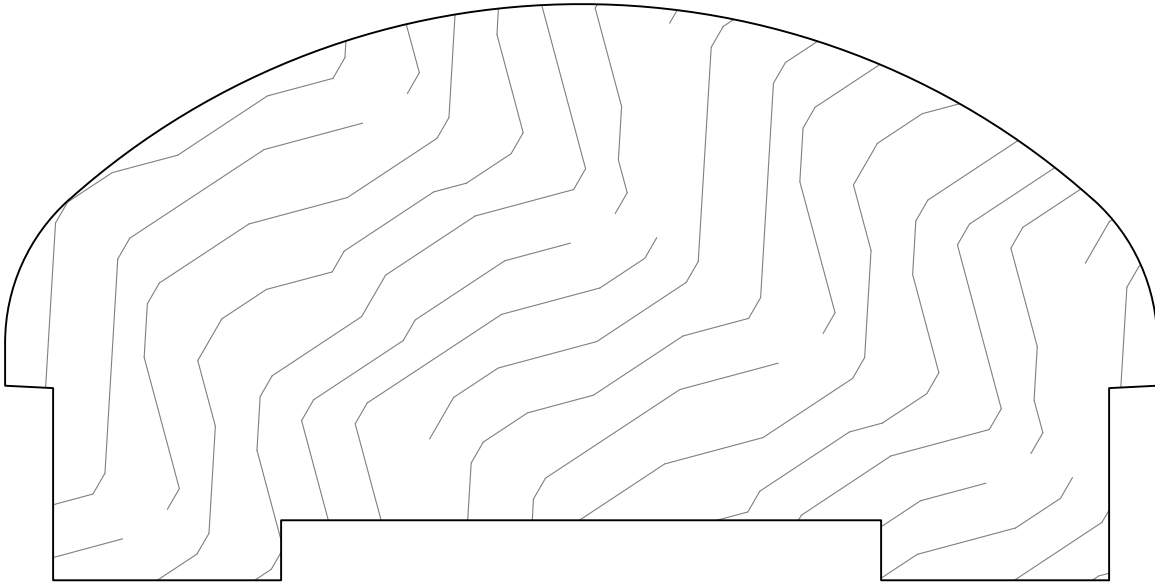

GCM5002  
3 x 6

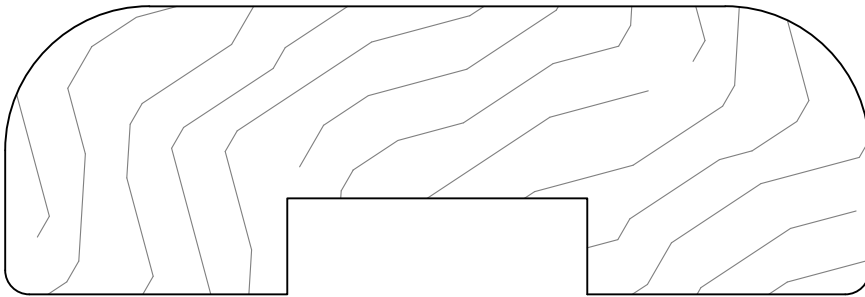

GCM5030  
1½ X 4½

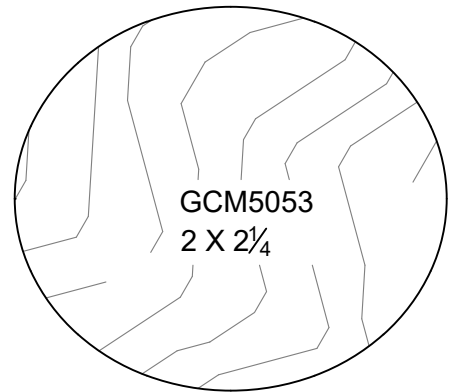

GCM5053  
2 X 2¼

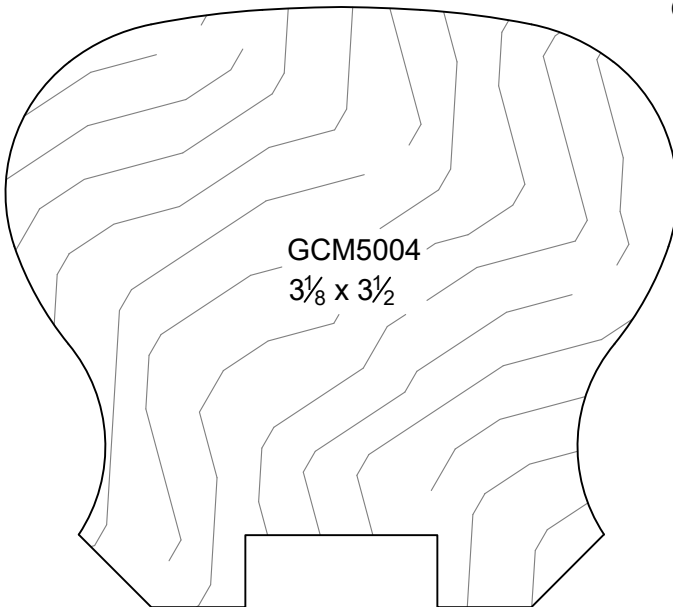

GCM5004  
3⅞ x 3½

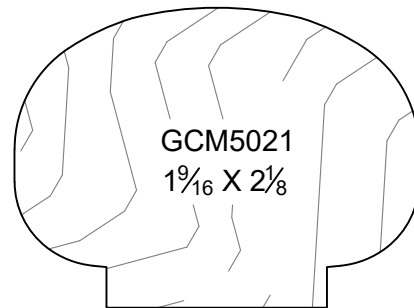

GCM5021  
1⅞ X 2⅞

# GRAYCO BUILDING CENTER

WWW.GRAYCOINC.COM

BLUFFTON  
345 BUCK ISLAND RD, BLUFFTON SC 29910  
(843) 815-5788 FAX 815-5799

LADY'S ISLAND  
20 SAMS POINT WAY, BEAUFORT SC 29907  
(843) 522-9994 FAX 522-9972

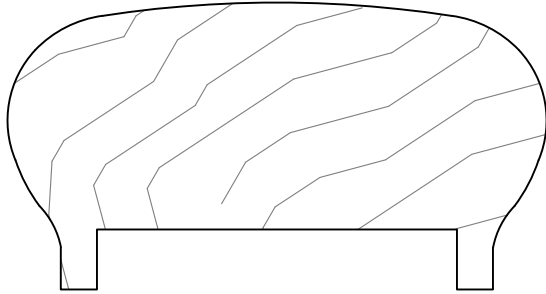

GCM84215  
1½ x 2<sup>13</sup>/<sub>16</sub>

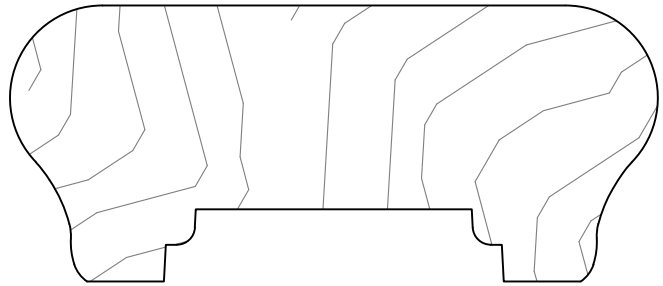

GCM5013  
1<sup>7</sup>/<sub>16</sub> x 3<sup>3</sup>/<sub>8</sub>

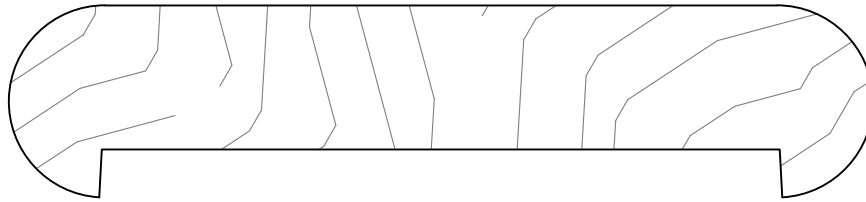

GCM5405  
1 x 4½

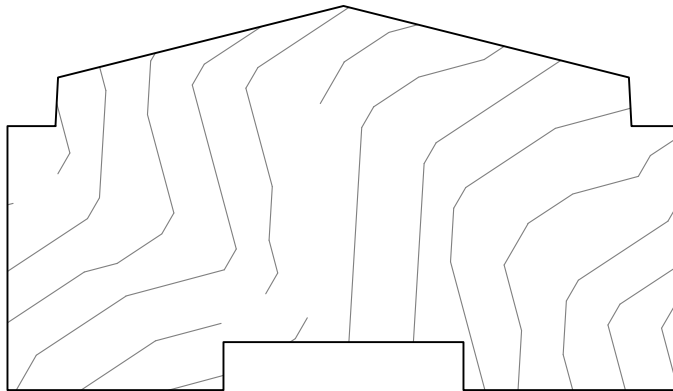

GCM5014  
2 X 3½

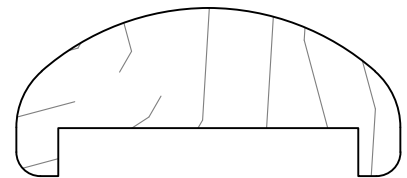

GCM5040  
7/8 X 2

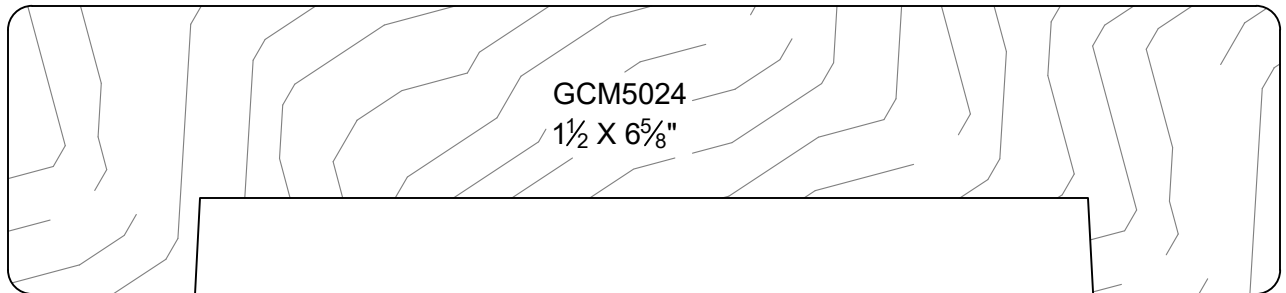

GCM5024  
1½ X 6<sup>5</sup>/<sub>8</sub>"

# GRAYCO BUILDING CENTER

WWW.GRAYCOINC.COM

BLUFFTON  
345 BUCK ISLAND RD, BLUFFTON SC 29910  
(843) 815-5788 FAX 815-5799

LADY'S ISLAND  
20 SAMS POINT WAY, BEAUFORT SC 29907  
(843) 522-9994 FAX 522-9972

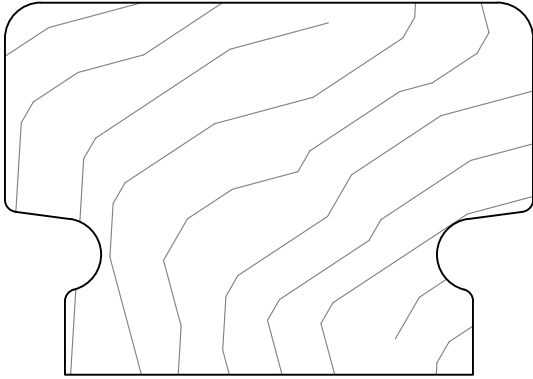

GCM5057  
1<sup>15</sup>/<sub>16</sub> X 2<sup>3</sup>/<sub>4</sub>

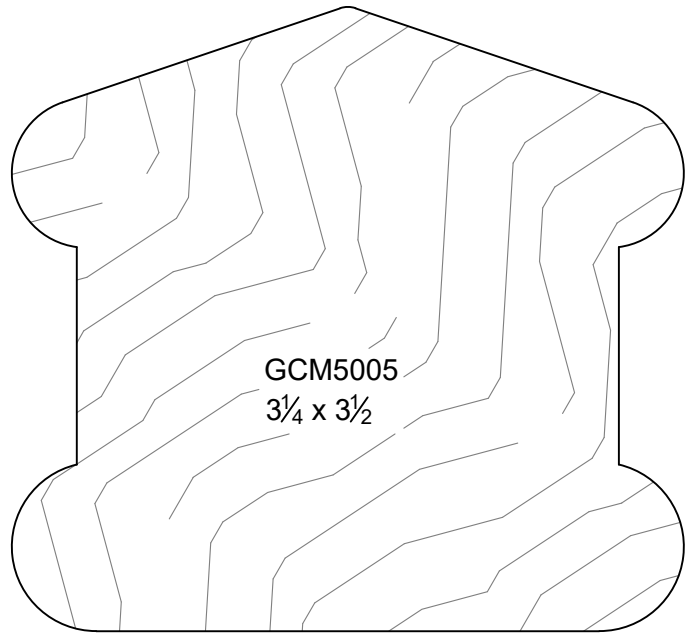

GCM5005  
3<sup>1</sup>/<sub>4</sub> x 3<sup>1</sup>/<sub>2</sub>

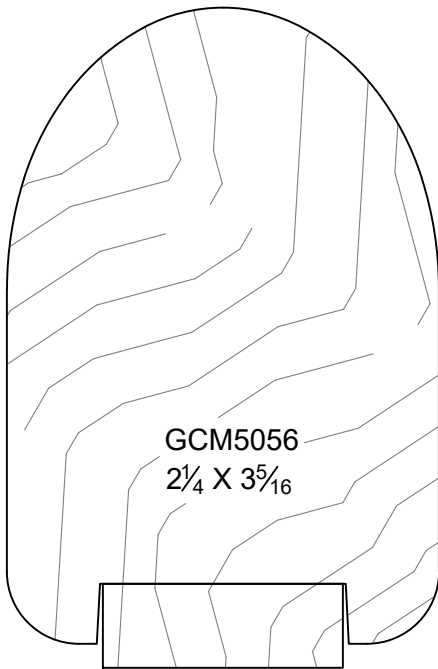

GCM5056  
2<sup>1</sup>/<sub>4</sub> X 3<sup>5</sup>/<sub>16</sub>

# GRAYCO BUILDING CENTER

WWW.GRAYCOINC.COM

BLUFFTON  
345 BUCK ISLAND RD, BLUFFTON SC 29910  
(843) 815-5788 FAX 815-5799

LADY'S ISLAND  
20 SAMS POINT WAY, BEAUFORT SC 29907  
(843) 522-9994 FAX 522-9972

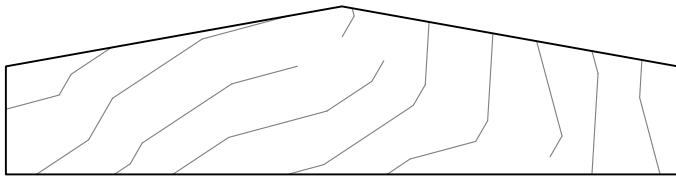

GCM5009  
7/8 x 3 1/2



GCM5043  
2 3/4 DIA



GCM5026  
3" DIA

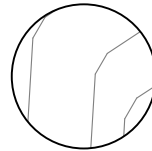

GCM6069  
3/4" DIA



GCM5049  
2 1/4 DIA



GCM5011  
1 1/2 DIA

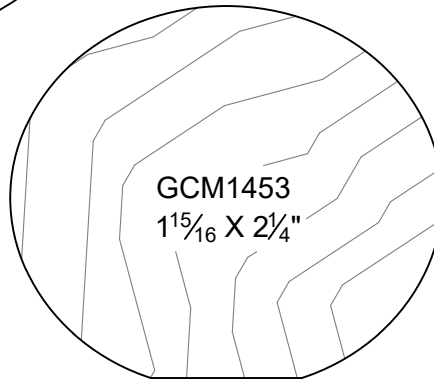

GCM1453  
1 5/16 X 2 1/4"

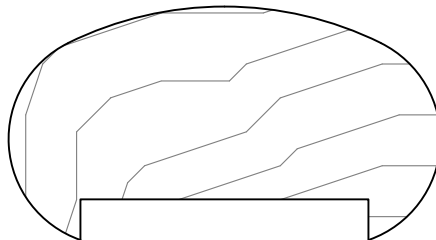

GCM5050  
1 1/4 X 2 1/4



GCM5018  
2" DIA

# GRAYCO BUILDING CENTER

WWW.GRAYCOINC.COM

BLUFFTON  
345 BUCK ISLAND RD, BLUFFTON SC 29910  
(843) 815-5788 FAX 815-5799

LADY'S ISLAND  
20 SAMS POINT WAY, BEAUFORT SC 29907  
(843) 522-9994 FAX 522-9972

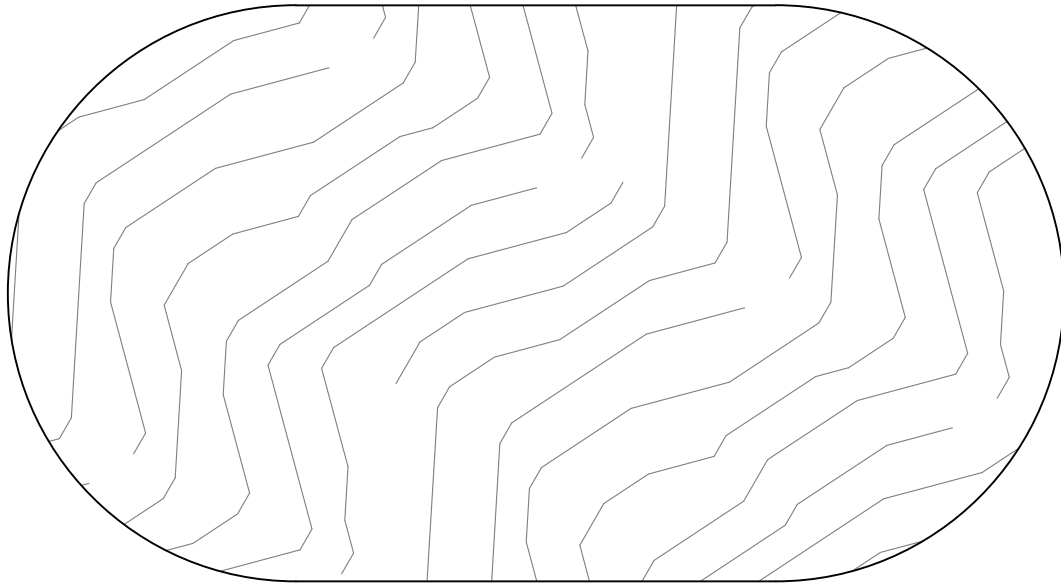

GCM5027  
3 X 5½"

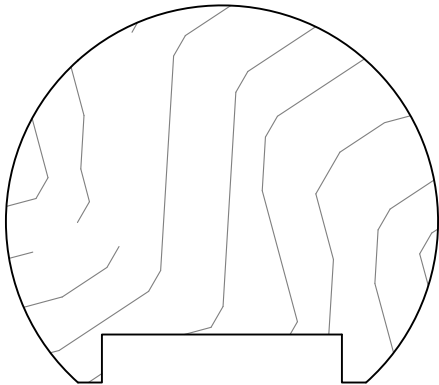

GCM5007  
2¼ DIA

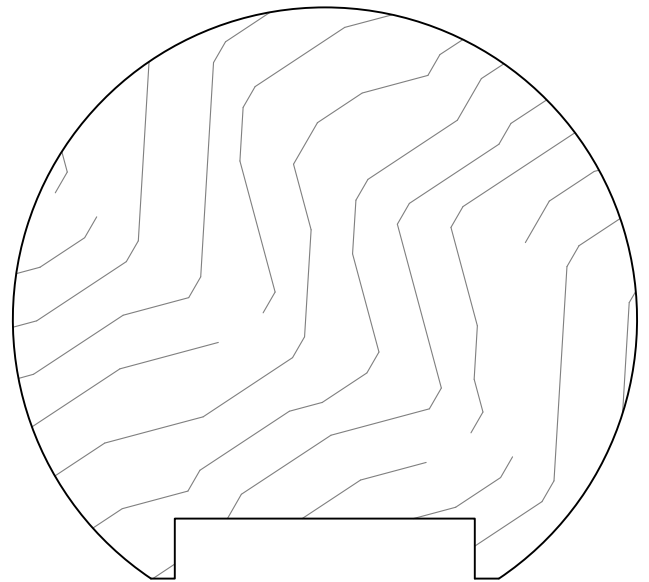

GCM5048  
3¼ DIA

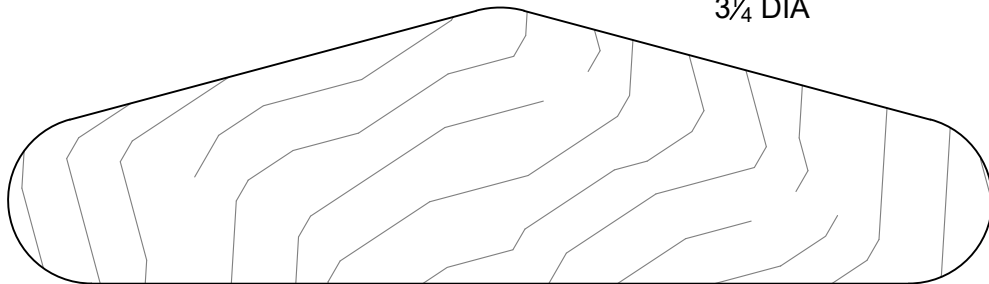

GCM5047  
1⅞ X 5⅞

# GRAYCO BUILDING CENTER

WWW.GRAYCOINC.COM

BLUFFTON  
345 BUCK ISLAND RD, BLUFFTON SC 29910  
(843) 815-5788 FAX 815-5799

LADY'S ISLAND  
20 SAMS POINT WAY, BEAUFORT SC 29907  
(843) 522-9994 FAX 522-9972



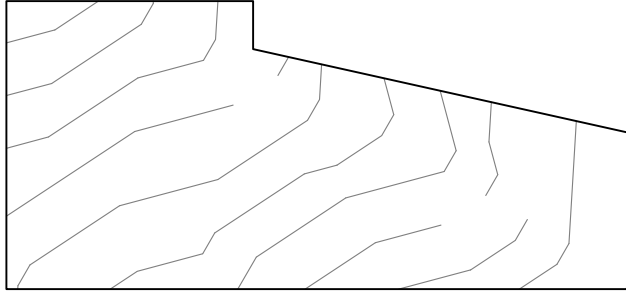

GCM84325  
1½ x ¾

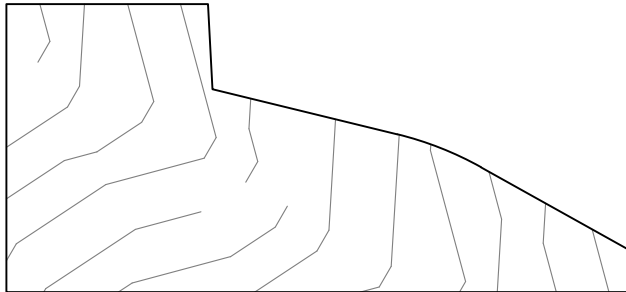

GCM84325C (1" PICKET)  
1½ x ¾

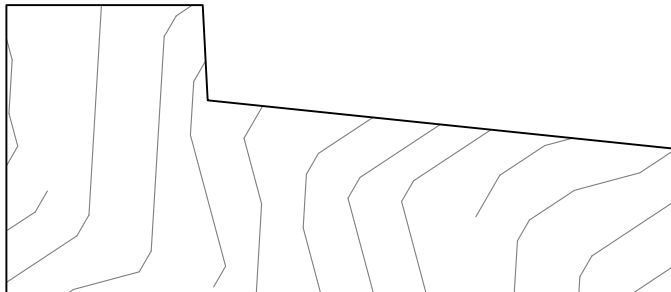

GCM5008 (1-1/2" PICKET)  
1½ x 3½

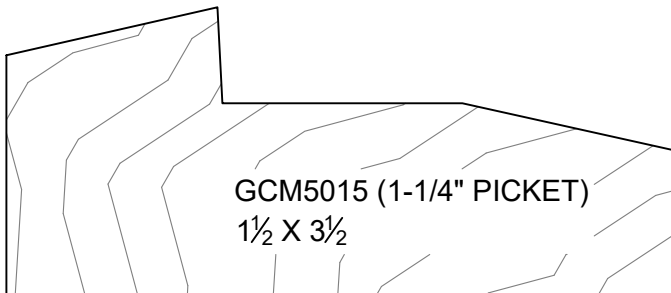

GCM5015 (1-1/4" PICKET)  
1½ X 3½

# GRAYCO BUILDING CENTER

WWW.GRAYCOINC.COM

BLUFFTON  
345 BUCK ISLAND RD, BLUFFTON SC 29910  
(843) 815-5788 FAX 815-5799

LADY'S ISLAND  
20 SAMS POINT WAY, BEAUFORT SC 29907  
(843) 522-9994 FAX 522-9972

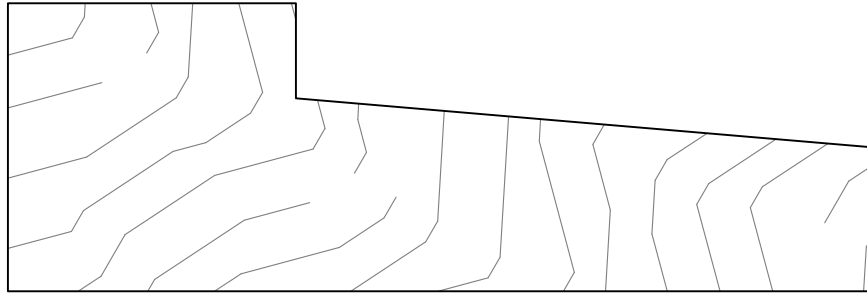

GCM5031 (1-1/2" PICKET)  
1½ X 4½

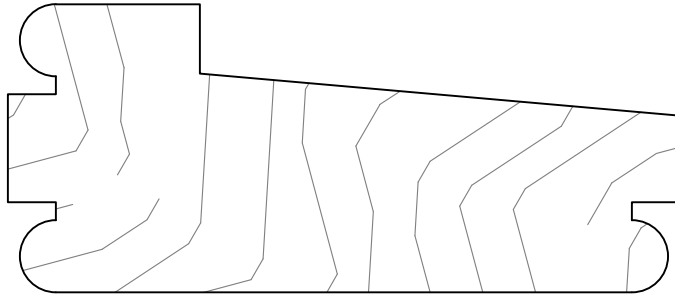

GCM5033 (1-1/2" PICKET)  
1½ x 3½

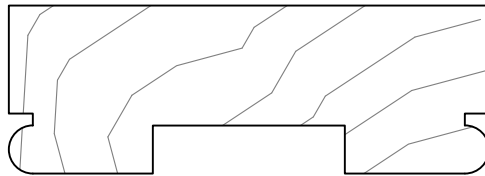

GCM5039  
7/8 X 2½ ( 1" Picket)

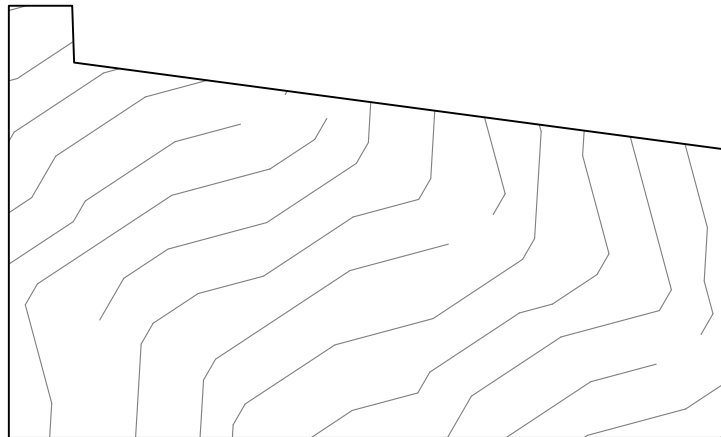

GCM5045  
2¼ X 3¾

## GRAYCO BUILDING CENTER

WWW.GRAYCOINC.COM

BLUFFTON  
345 BUCK ISLAND RD, BLUFFTON SC 29910  
(843) 815-5788 FAX 815-5799

LADY'S ISLAND  
20 SAMS POINT WAY, BEAUFORT SC 29907  
(843) 522-9994 FAX 522-9972

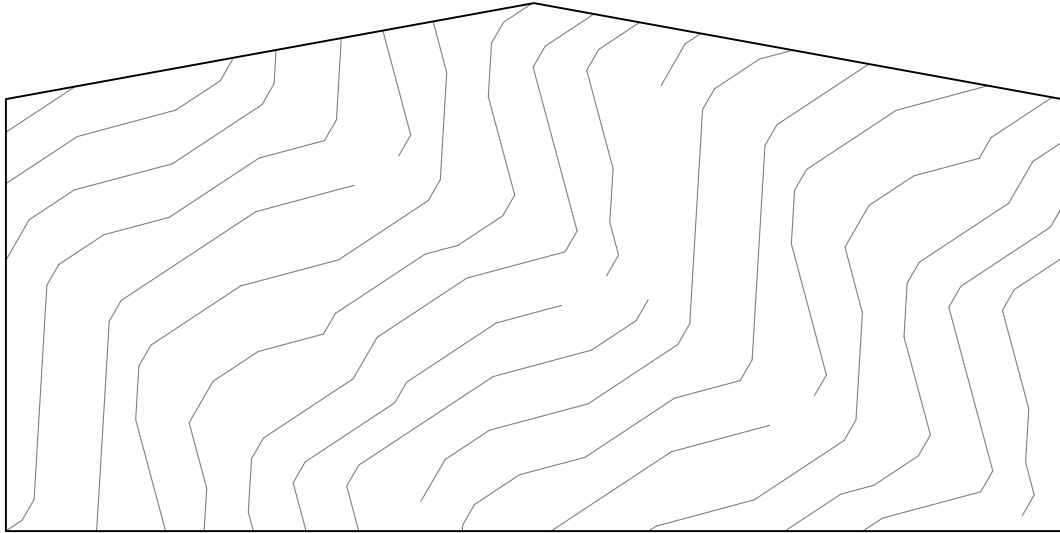

GCM5028  
2<sup>3</sup>/<sub>4</sub> X 5<sup>1</sup>/<sub>2</sub>

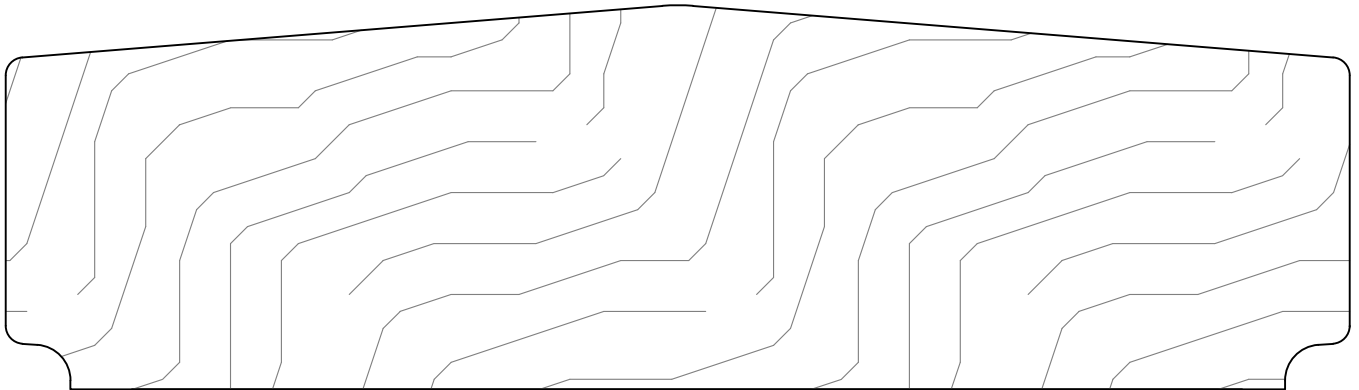

GCM5029  
2 x 7"

## GRAYCO BUILDING CENTER

[WWW.GRAYCOINC.COM](http://WWW.GRAYCOINC.COM)

BLUFFTON  
345 BUCK ISLAND RD, BLUFFTON SC 29910  
(843) 815-5788 FAX 815-5799

LADY'S ISLAND  
20 SAMS POINT WAY, BEAUFORT SC 29907  
(843) 522-9994 FAX 522-9972

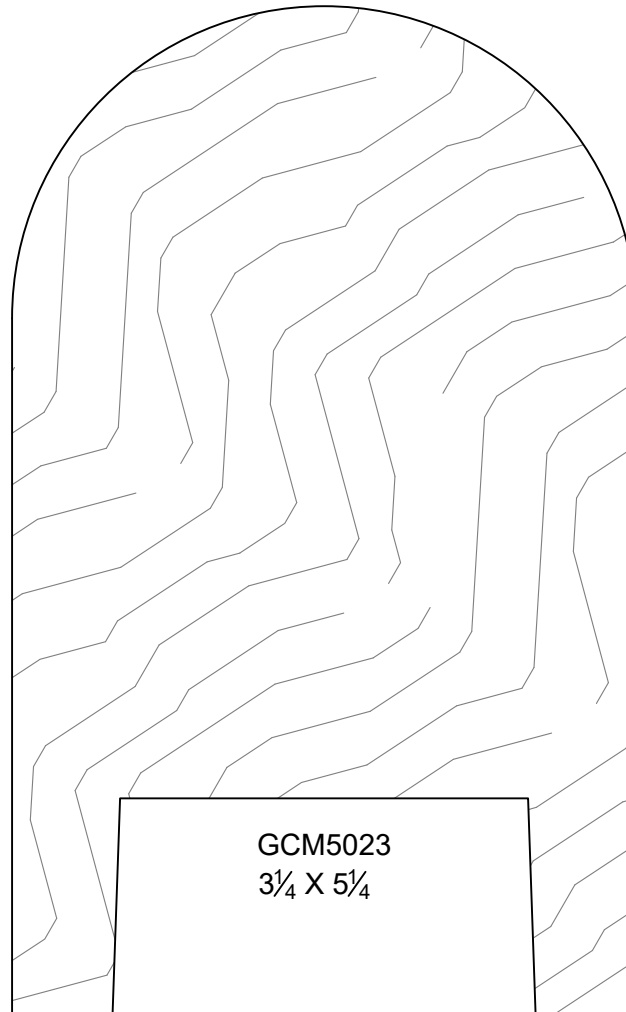
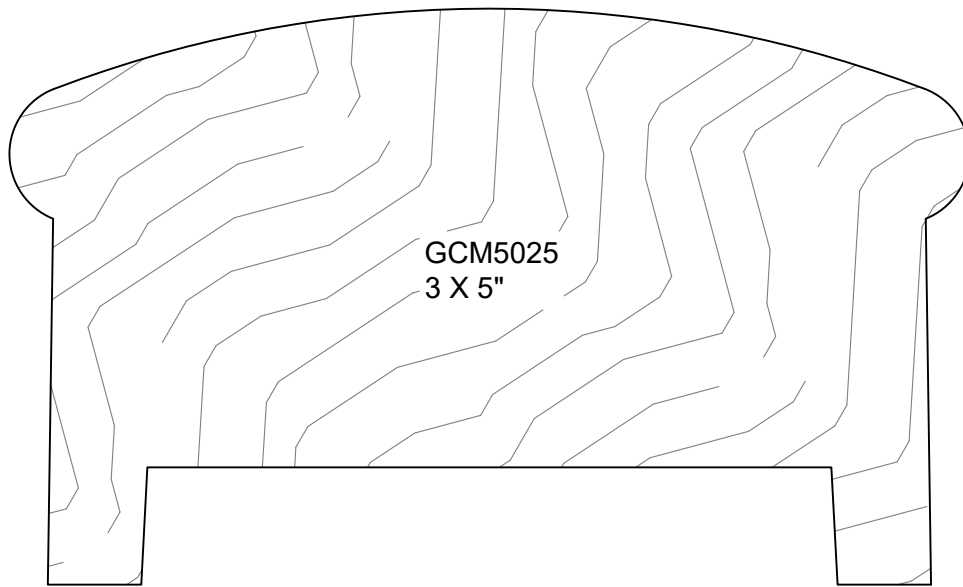

# GRAYCO BUILDING CENTER

WWW.GRAYCOINC.COM

BLUFFTON  
345 BUCK ISLAND RD, BLUFFTON SC 29910  
(843) 815-5788 FAX 815-5799

LADY'S ISLAND  
20 SAMS POINT WAY, BEAUFORT SC 29907  
(843) 522-9994 FAX 522-9972

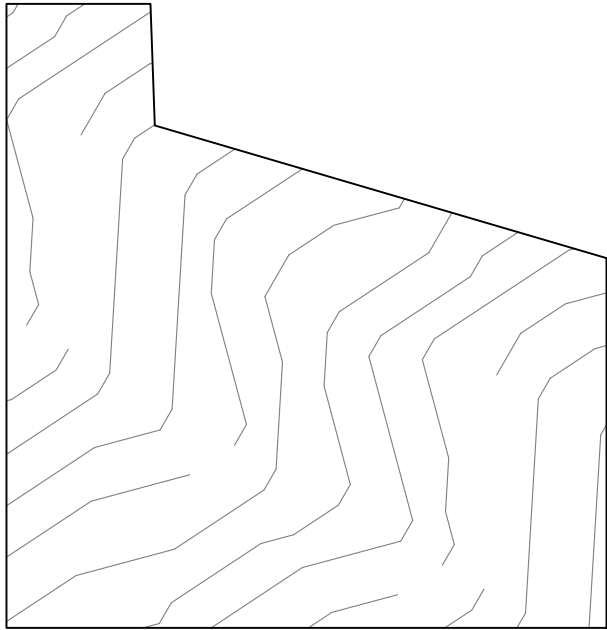

GCM5035  
3¼ X 3⅛

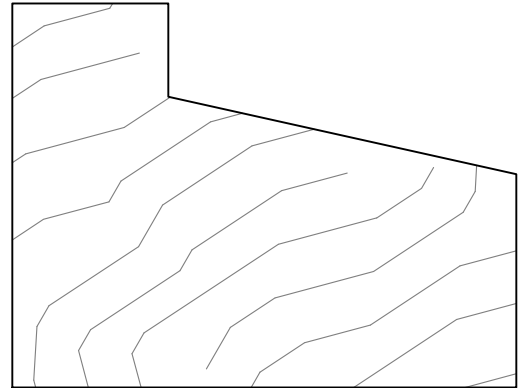

GCM5038  
2 X 2⅝

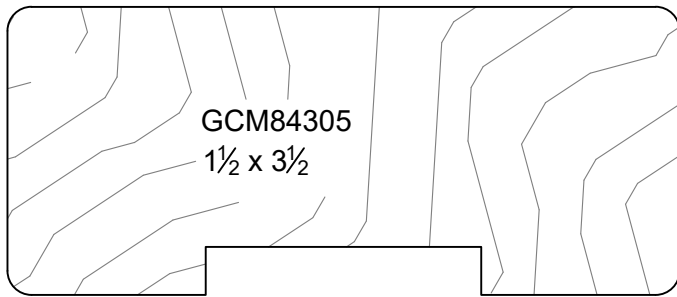

GCM84305  
1½ x 3½

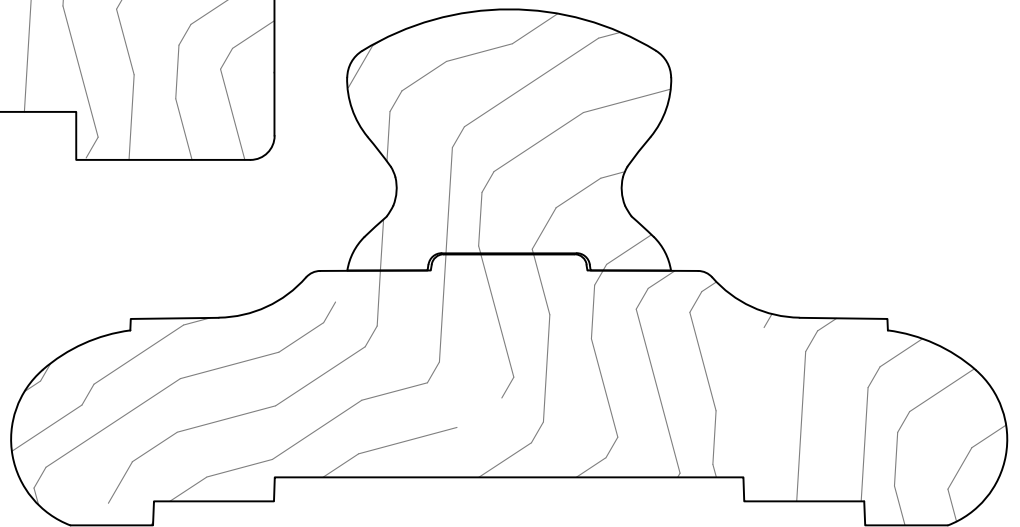

GCM5044  
2⅛ X 5⅜

## GRAYCO BUILDING CENTER

WWW.GRAYCOINC.COM

BLUFFTON  
345 BUCK ISLAND RD, BLUFFTON SC 29910  
(843) 815-5788 FAX 815-5799

LADY'S ISLAND  
20 SAMS POINT WAY, BEAUFORT SC 29907  
(843) 522-9994 FAX 522-9972



GCM5042  
1¼ x 5

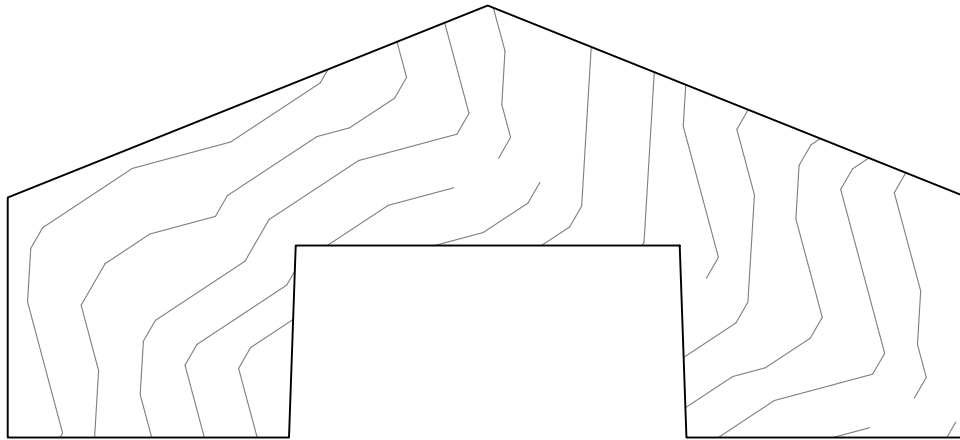

GCM5051  
2¼ x 5

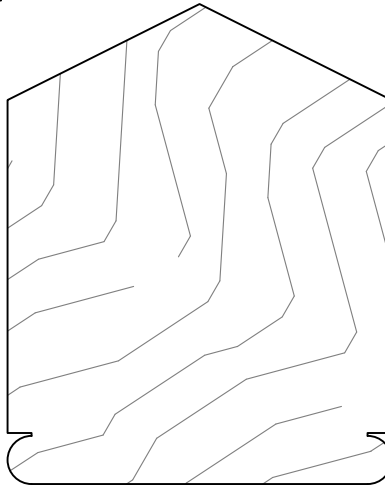

GCM5054  
2½ x 2

# GRAYCO BUILDING CENTER

WWW.GRAYCOINC.COM

BLUFFTON  
345 BUCK ISLAND RD, BLUFFTON SC 29910  
(843) 815-5788 FAX 815-5799

LADY'S ISLAND  
20 SAMS POINT WAY, BEAUFORT SC 29907  
(843) 522-9994 FAX 522-9972



GCM5041  
3 $\frac{1}{16}$  X 6 $\frac{3}{4}$

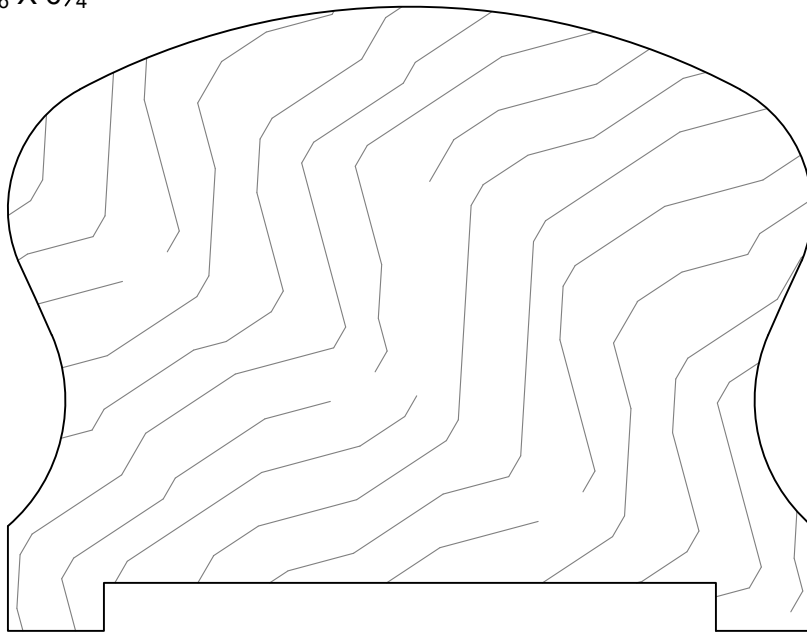

GCM5046  
3 $\frac{1}{4}$  X 4 $\frac{3}{16}$

# GRAYCO BUILDING CENTER

[WWW.GRAYCOINC.COM](http://WWW.GRAYCOINC.COM)

BLUFFTON  
345 BUCK ISLAND RD, BLUFFTON SC 29910  
(843) 815-5788 FAX 815-5799

LADY'S ISLAND  
20 SAMS POINT WAY, BEAUFORT SC 29907  
(843) 522-9994 FAX 522-9972

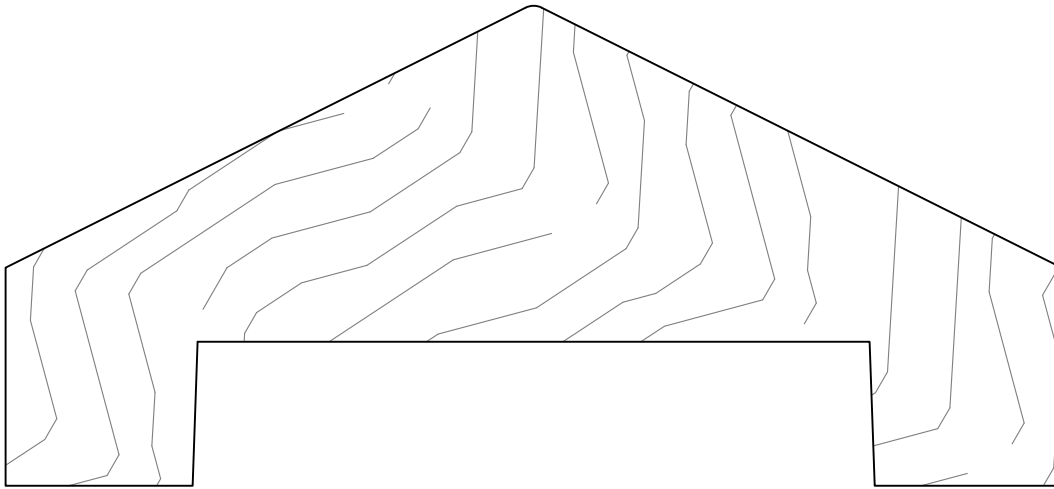

GCM5016  
2½ X 5½

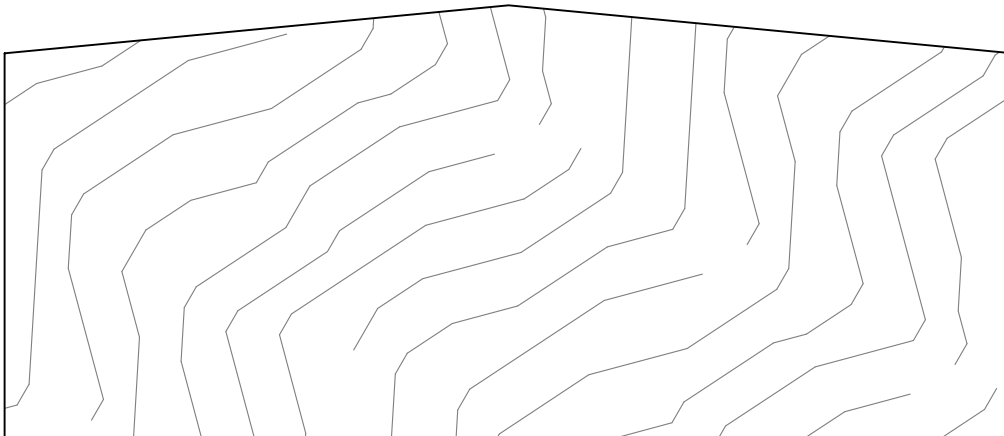

GCM5022  
2¼ X 5¼"

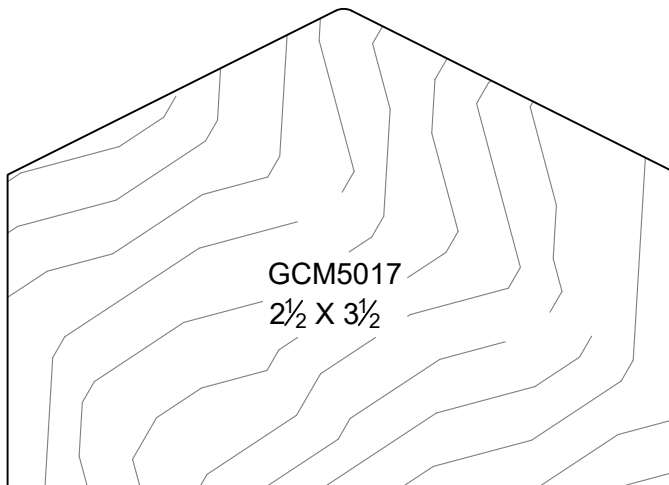

GCM5017  
2½ X 3½

# GRAYCO BUILDING CENTER

WWW.GRAYCOINC.COM

BLUFFTON  
345 BUCK ISLAND RD, BLUFFTON SC 29910  
(843) 815-5788 FAX 815-5799

LADY'S ISLAND  
20 SAMS POINT WAY, BEAUFORT SC 29907  
(843) 522-9994 FAX 522-9972





GCM1471  
1<sup>1</sup>/<sub>16</sub> x 2<sup>1</sup>/<sub>4</sub>

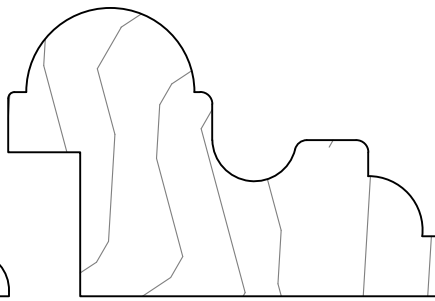

GCM80817  
1<sup>1</sup>/<sub>2</sub> x 2<sup>1</sup>/<sub>4</sub>

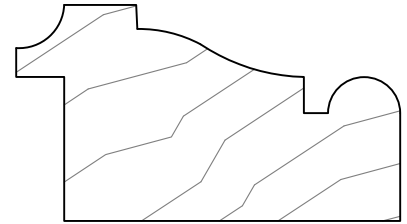

GCM1260  
1<sup>1</sup>/<sub>8</sub> x 2

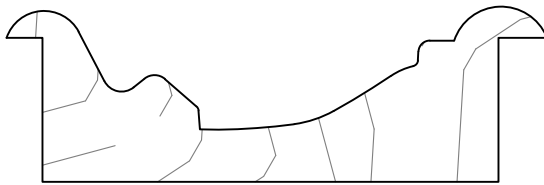

GCM5513  
1<sup>5</sup>/<sub>16</sub> x 2<sup>13</sup>/<sub>16</sub>

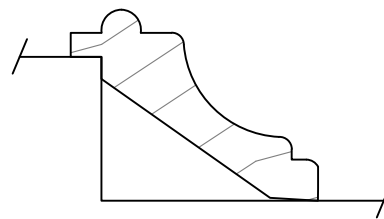

GCM1218  
7<sup>7</sup>/<sub>16</sub> x 1<sup>9</sup>/<sub>16</sub>

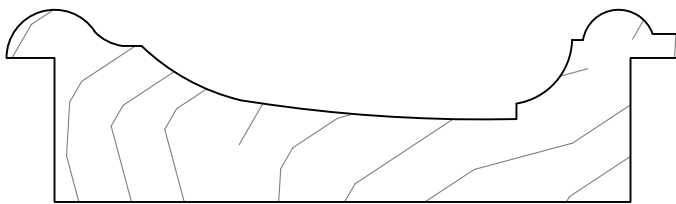

GCM1483  
1 x 3<sup>1</sup>/<sub>2</sub>

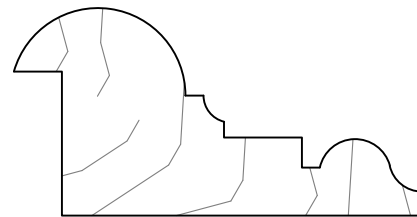

GCM9809  
1<sup>1</sup>/<sub>16</sub> x 2<sup>7</sup>/<sub>8</sub>

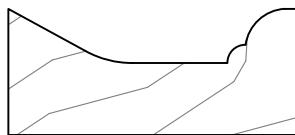

GCM5503  
2<sup>1</sup>/<sub>32</sub> x 1<sup>1</sup>/<sub>2</sub>

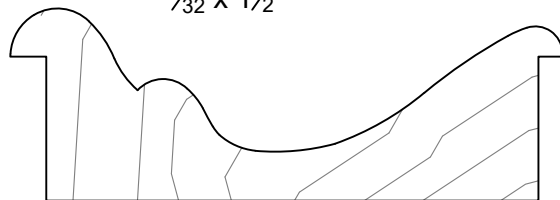

GCM5505  
1 x 2<sup>7</sup>/<sub>8</sub>"

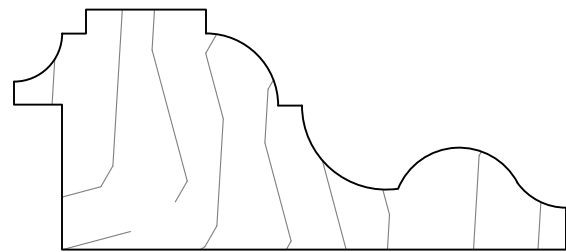

GCM9855  
1<sup>1</sup>/<sub>4</sub> x 2<sup>7</sup>/<sub>8</sub>

# GRAYCO BUILDING CENTER

WWW.GRAYCOINC.COM

BLUFFTON  
345 BUCK ISLAND RD, BLUFFTON SC 29910  
(843) 815-5788 FAX 815-5799

LADY'S ISLAND  
20 SAMS POINT WAY, BEAUFORT SC 29907  
(843) 522-9994 FAX 522-9972



GCM898  
3/8 x 1/4

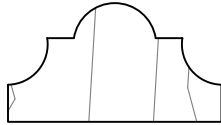

GCM135  
1/8 x 5/8

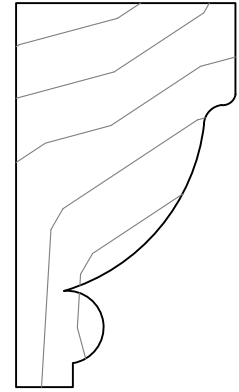

GCM3513  
1/8 x 2

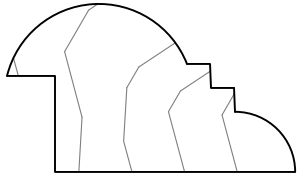

GCM2015  
7/8 x 1 1/2"

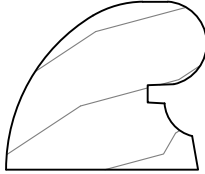

GCM5504  
7/8 x 1

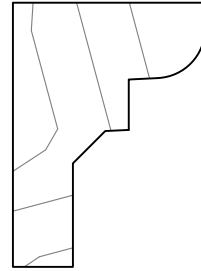

GCM5052  
1 x 1 3/8

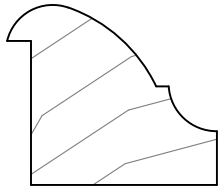

GCM2016  
1 5/16 x 1 3/32"

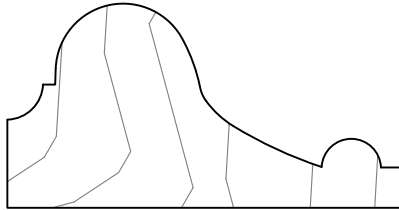

GCM50041  
1 1/16 x 2 1/16"

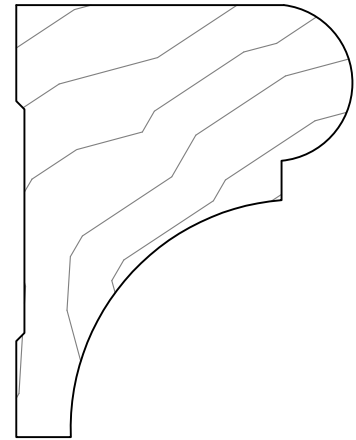

GCM1105  
1 3/4 x 2 1/4



GCM6024  
5/8 x 3/4

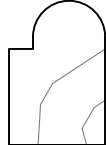

GCM649  
1/2 x 3/4



GCM1040  
9/16 x 1/2

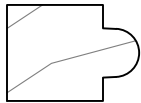

GCM6025  
1/2 x 1 1/16

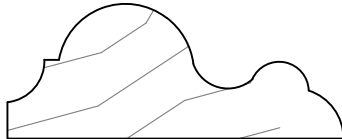

GCM3041  
1 1/16 x 1 3/4

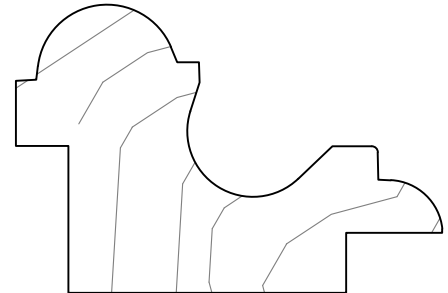

GCM5516  
1 1/2 x 2 1/4

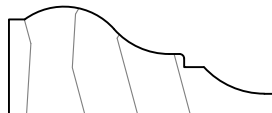

GCM6063  
9/16 x 1 3/8

# GRAYCO BUILDING CENTER

WWW.GRAYCOINC.COM

BLUFFTON  
345 BUCK ISLAND RD, BLUFFTON SC 29910  
(843) 815-5788 FAX 815-5799

LADY'S ISLAND  
20 SAMS POINT WAY, BEAUFORT SC 29907  
(843) 522-9994 FAX 522-9972

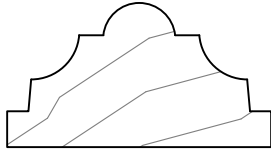

GCM428  
3/4 X 1 3/8

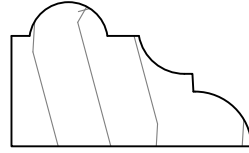

GCM1259  
3/4 x 1 1/4

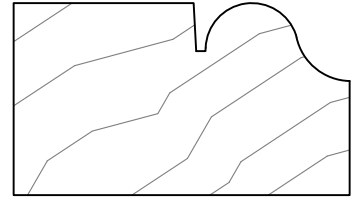

GCM2502MOD  
1 X 1 3/4

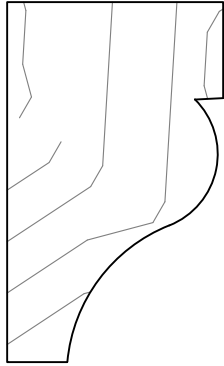

GCM16  
1 1/8 x 1 7/8

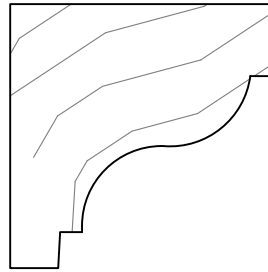

GCM1788  
1 3/8 x 1 3/8

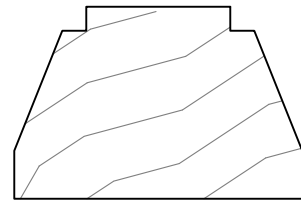

GCM5501  
3/4 x 1 1/2

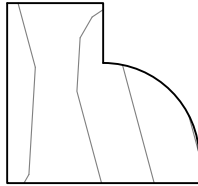

GCM302  
1 1/16 x 2 3/4

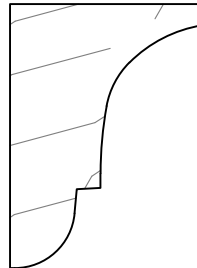

GCM4002  
1 X 1 3/8"

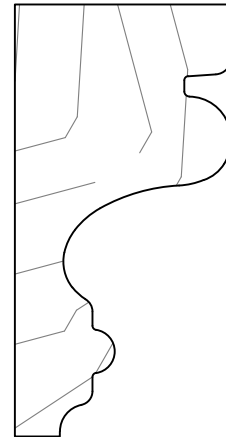

GCM6056  
1 1/8 x 2 1/4

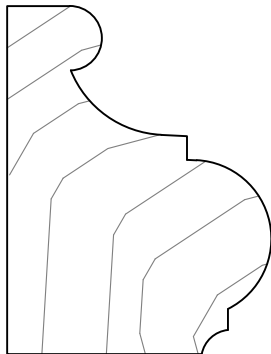

GCM5502  
1 3/8 x 1 13/16

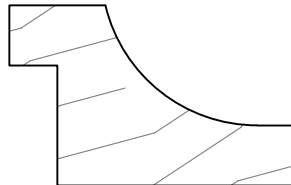

GCM5512  
1 5/16 X 1 1/2"

# GRAYCO BUILDING CENTER

WWW.GRAYCOINC.COM

BLUFFTON  
345 BUCK ISLAND RD, BLUFFTON SC 29910  
(843) 815-5788 FAX 815-5799

LADY'S ISLAND  
20 SAMS POINT WAY, BEAUFORT SC 29907  
(843) 522-9994 FAX 522-9972

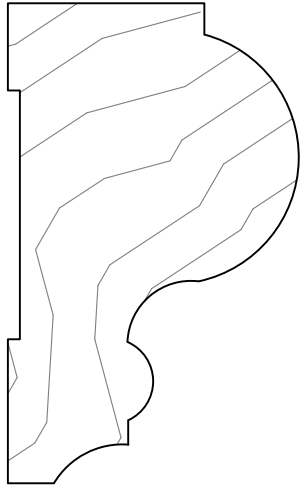

GCM305  
1½ x 2½

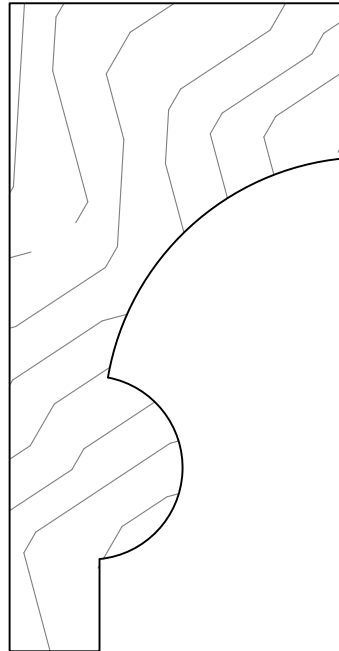

GCM1104  
1¾ x 3⅜

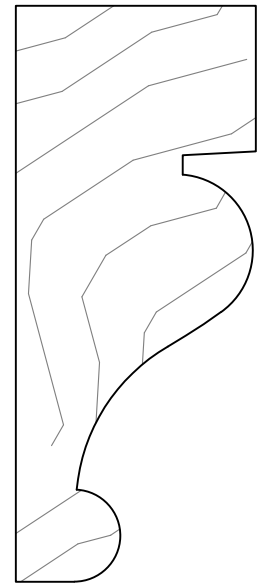

GCM1036  
¼ X 3"

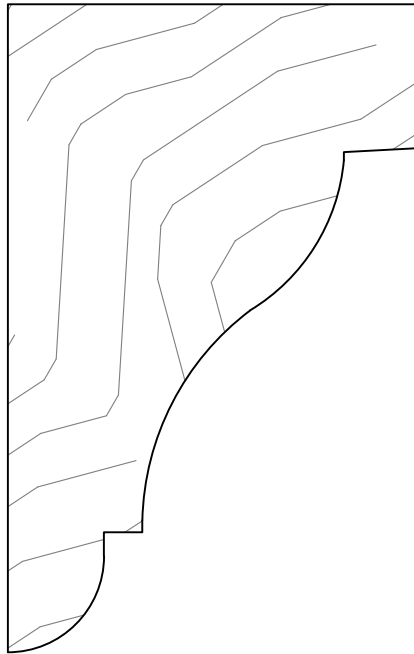

GCM1382  
2⅛ x 3⅜

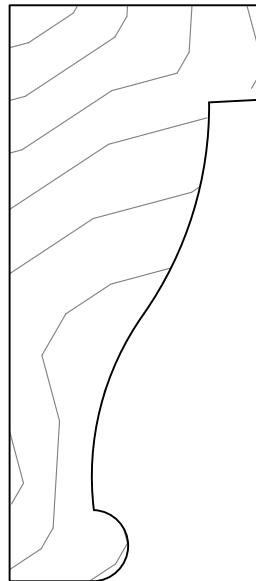

GCM788  
1⅝ x 3

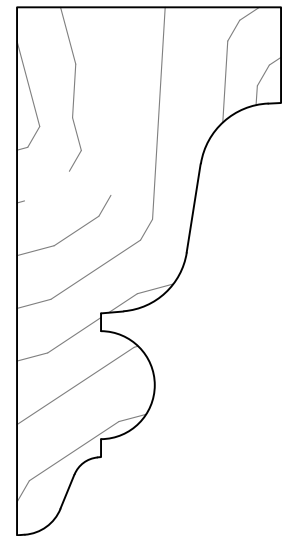

GCM8282  
1⅜ X 2¾

# GRAYCO BUILDING CENTER

WWW.GRAYCOINC.COM

BLUFFTON  
345 BUCK ISLAND RD, BLUFFTON SC 29910  
(843) 815-5788 FAX 815-5799

LADY'S ISLAND  
20 SAMS POINT WAY, BEAUFORT SC 29907  
(843) 522-9994 FAX 522-9972



GCM578  
 $1\frac{5}{8} \times 3\frac{1}{16}$

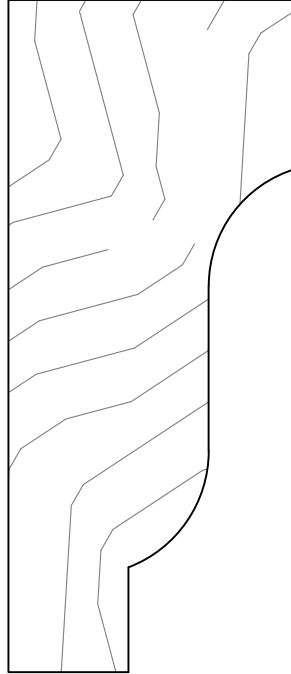

GCM6054  
 $1\frac{1}{2} \times 3\frac{1}{2}$

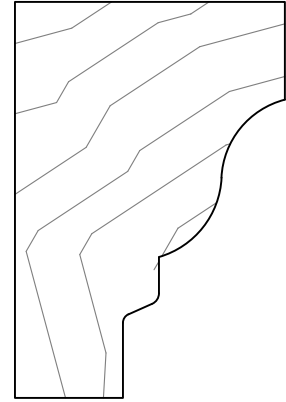

GCM6934  
 $1\frac{13}{32} \times 2\frac{1}{16}$

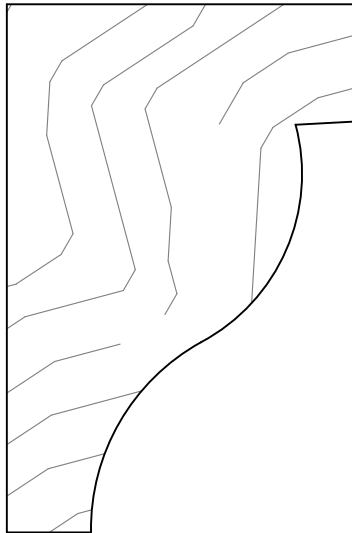

GCM1622  
 $1\frac{13}{16} \times 2\frac{3}{4}$

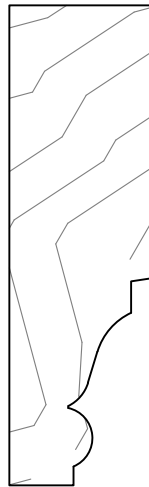

GCM4008  
 $\frac{3}{4} \times 2\frac{1}{2}$

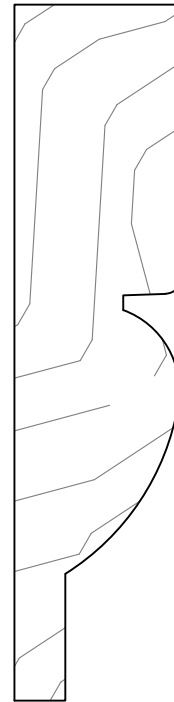

GCM4009  
 $\frac{7}{8} \times 3\frac{5}{8}$

# GRAYCO BUILDING CENTER

WWW.GRAYCOINC.COM

BLUFFTON  
345 BUCK ISLAND RD, BLUFFTON SC 29910  
(843) 815-5788 FAX 815-5799

LADY'S ISLAND  
20 SAMS POINT WAY, BEAUFORT SC 29907  
(843) 522-9994 FAX 522-9972

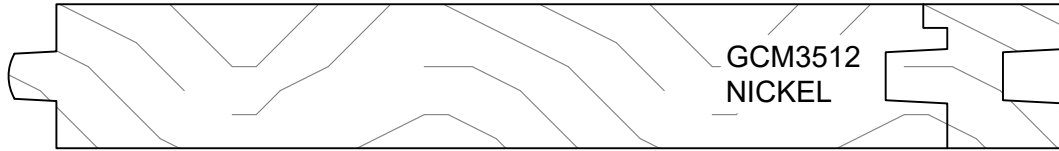

GCM3512  
3/4 x VARIES

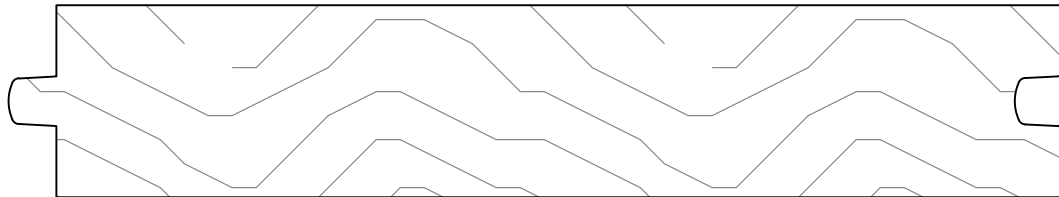

GCM3521  
UP TO 2" THICK €

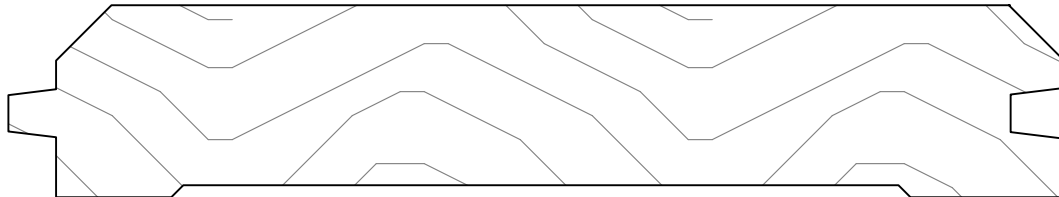

GCM3509  
1 x VARIES

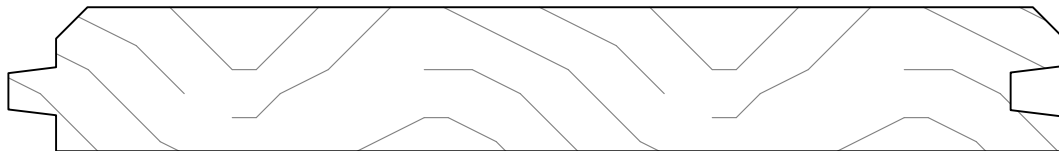

GCM3508  
3/4 x VARIES

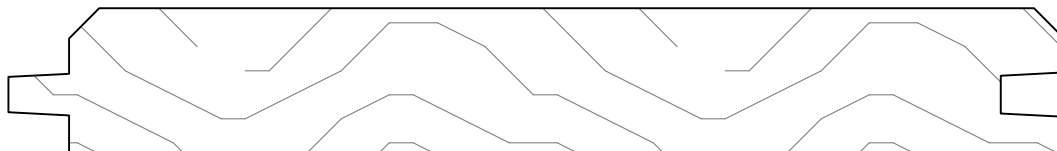

GCM3504  
3/4 x VARIES

# GRAYCO BUILDING CENTER

WWW.GRAYCOINC.COM

BLUFFTON  
345 BUCK ISLAND RD, BLUFFTON SC 29910  
(843) 815-5788 FAX 815-5799

LADY'S ISLAND  
20 SAMS POINT WAY, BEAUFORT SC 29907  
(843) 522-9994 FAX 522-9972

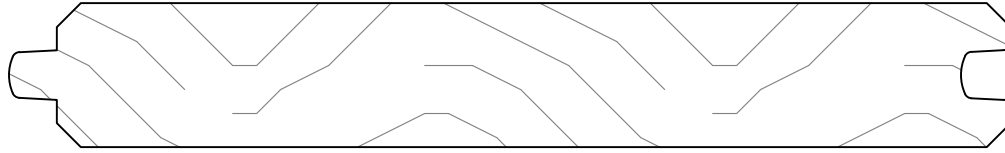

GCM3523  
3/4 X VARIES

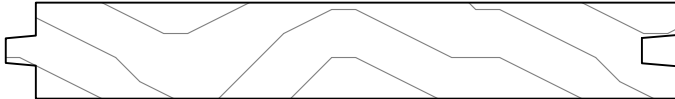

GCM3524  
1/2 x VARIES

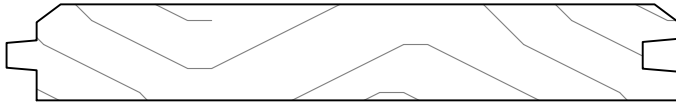

GCM3511  
1/2 x VARIES

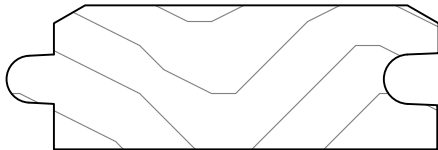

GCM3502  
3/4 x VARIES



GCM3528

# GRAYCO BUILDING CENTER

WWW.GRAYCOINC.COM

BLUFFTON  
345 BUCK ISLAND RD, BLUFFTON SC 29910  
(843) 815-5788 FAX 815-5799

LADY'S ISLAND  
20 SAMS POINT WAY, BEAUFORT SC 29907  
(843) 522-9994 FAX 522-9972

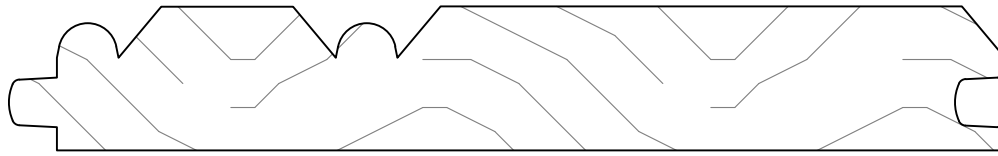

GCM3527

$\frac{3}{4}$  X  $5\frac{3}{16}$

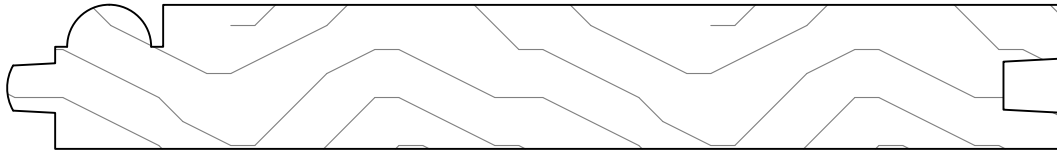

GCM3103

$\frac{3}{4}$  x VARIES

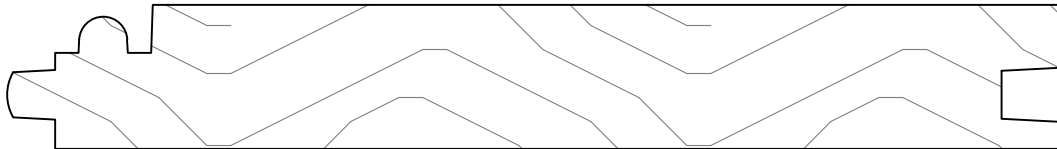

GCM3518

$\frac{3}{4}$  X VARIES



GCM3514

$\frac{1}{2}$  x VARIES

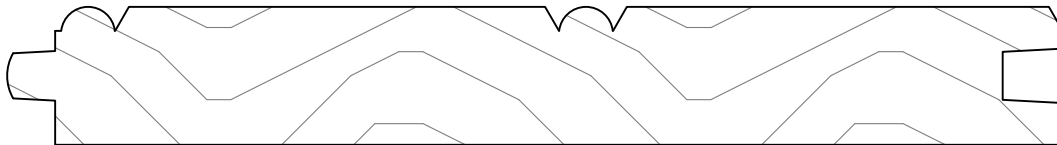

GCM3510

$\frac{3}{4}$  x  $5\frac{1}{2}$

# GRAYCO BUILDING CENTER

WWW.GRAYCOINC.COM

BLUFFTON  
345 BUCK ISLAND RD, BLUFFTON SC 29910  
(843) 815-5788 FAX 815-5799

LADY'S ISLAND  
20 SAMS POINT WAY, BEAUFORT SC 29907  
(843) 522-9994 FAX 522-9972



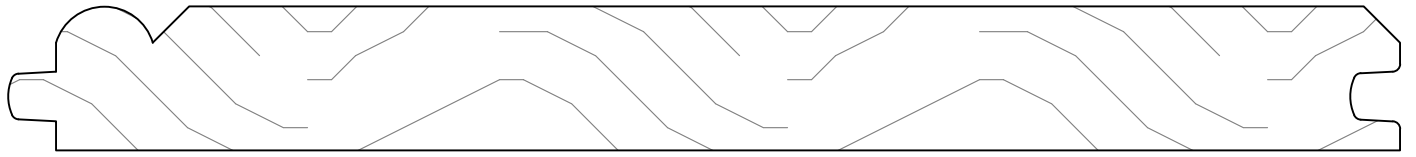

GCM7510  
 $\frac{3}{4} \times 7\frac{1}{4}$

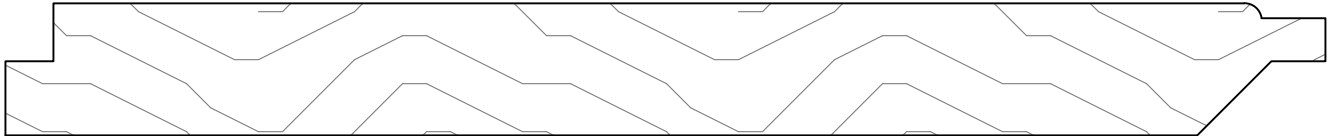

GCM7509  
 $1\frac{1}{16} \times 6\frac{7}{8}$

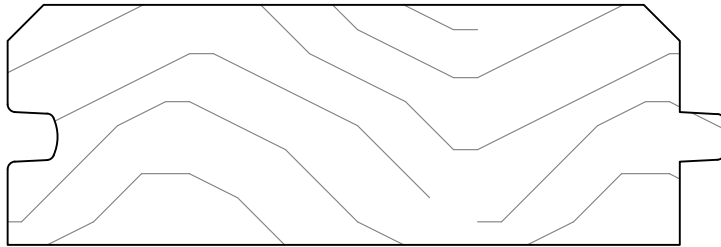

GCM3531  
 $1\frac{1}{4} \times \text{VARIES}$

# GRAYCO BUILDING CENTER

[WWW.GRAYCOINC.COM](http://WWW.GRAYCOINC.COM)

BLUFFTON  
345 BUCK ISLAND RD, BLUFFTON SC 29910  
(843) 815-5788 FAX 815-5799

LADY'S ISLAND  
20 SAMS POINT WAY, BEAUFORT SC 29907  
(843) 522-9994 FAX 522-9972

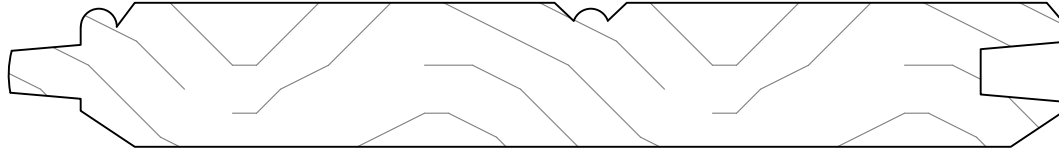

GCM3506

$\frac{3}{4} \times 5\frac{1}{2}$

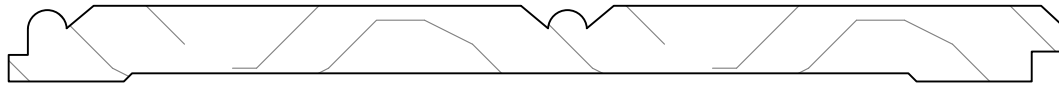

GCMS110 5.5

$\frac{7}{16} \times 5\frac{1}{2}$

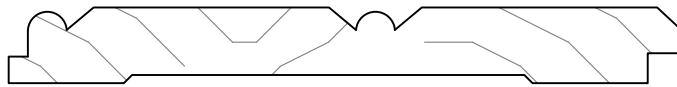

GCMS110 3.5

$\frac{7}{16} \times 3\frac{1}{2}$

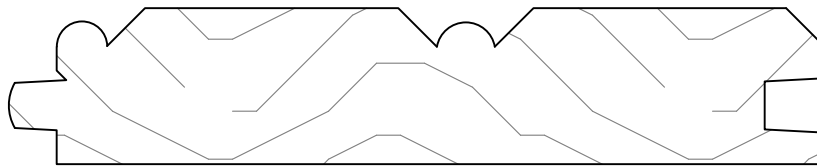

GCM3503

$1\frac{3}{16} \times 4\frac{1}{4}$

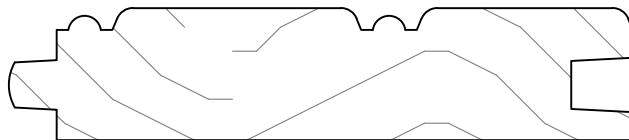

GCM3520

$\frac{3}{4} \times 3\frac{1}{4}$ "



GCM3517

$\frac{3}{4} \times \text{VARIES}$

# GRAYCO BUILDING CENTER

WWW.GRAYCOINC.COM

BLUFFTON  
345 BUCK ISLAND RD, BLUFFTON SC 29910  
(843) 815-5788 FAX 815-5799

LADY'S ISLAND  
20 SAMS POINT WAY, BEAUFORT SC 29907  
(843) 522-9994 FAX 522-9972

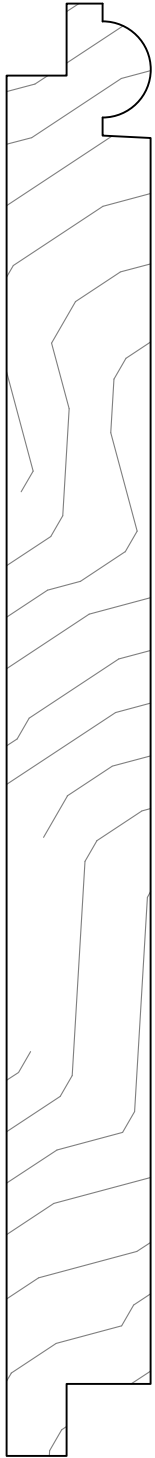

GCMSL850  
3/4 x VARIES

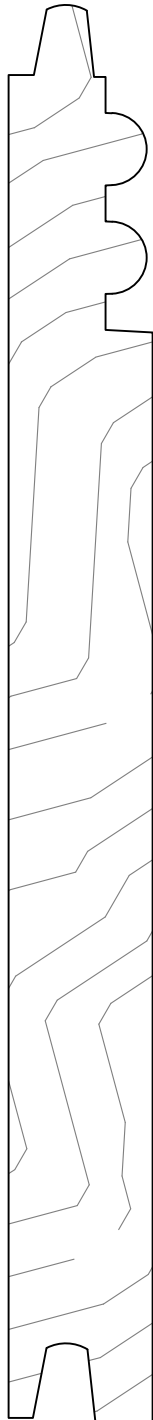

GCM3505  
3/4 x VARIES

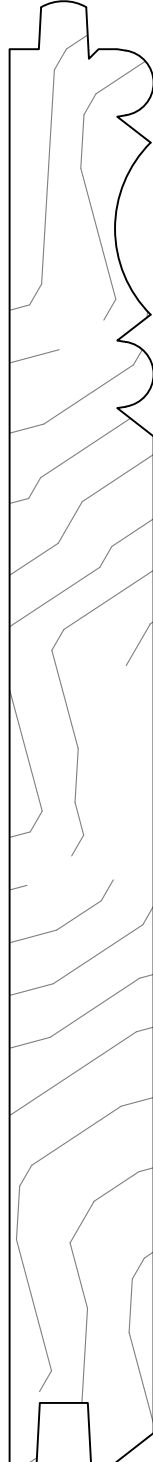

GCM3507  
3/4 x VARIES

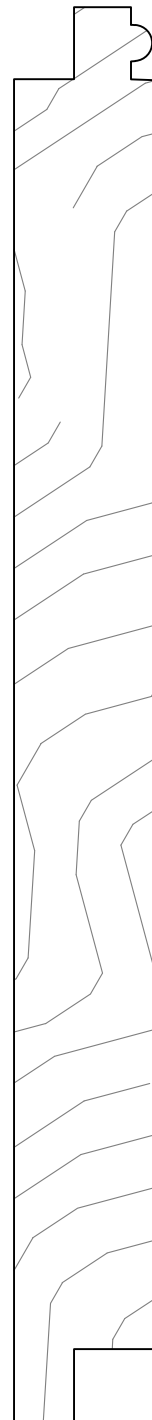

GCM3526  
3/4 X VARIES

## GRAYCO BUILDING CENTER

[WWW.GRAYCOINC.COM](http://WWW.GRAYCOINC.COM)

BLUFFTON  
345 BUCK ISLAND RD, BLUFFTON SC 29910  
(843) 815-5788 FAX 815-5799

LADY'S ISLAND  
20 SAMS POINT WAY, BEAUFORT SC 29907  
(843) 522-9994 FAX 522-9972

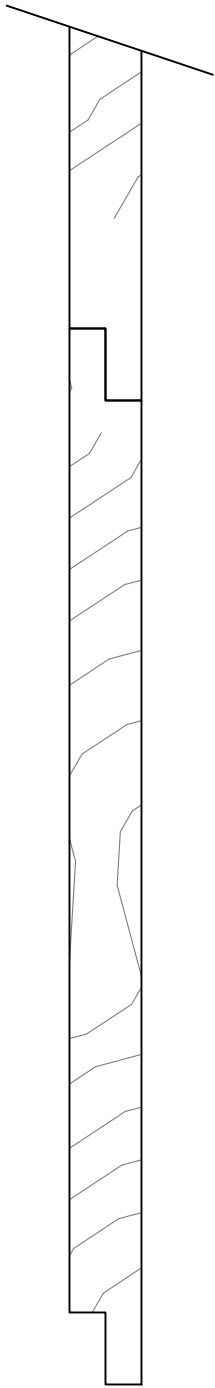

GCM3525  
3/8 X VARIES

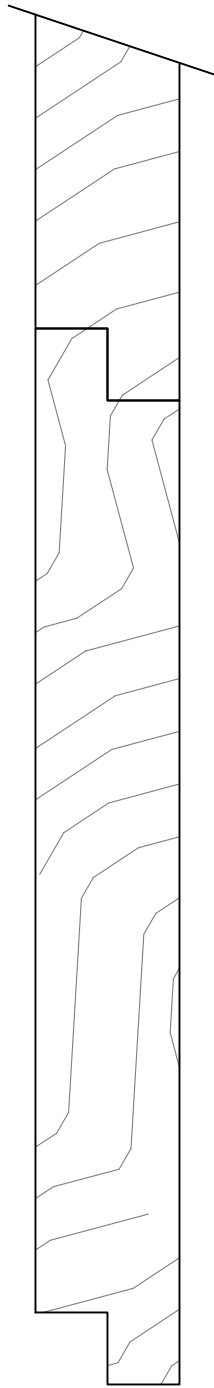

GCM3519  
3/4 x VARIES

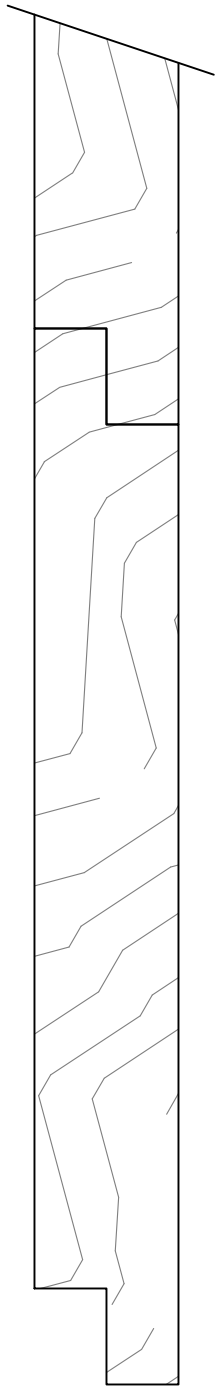

GCM3522  
3/4 x VARIES

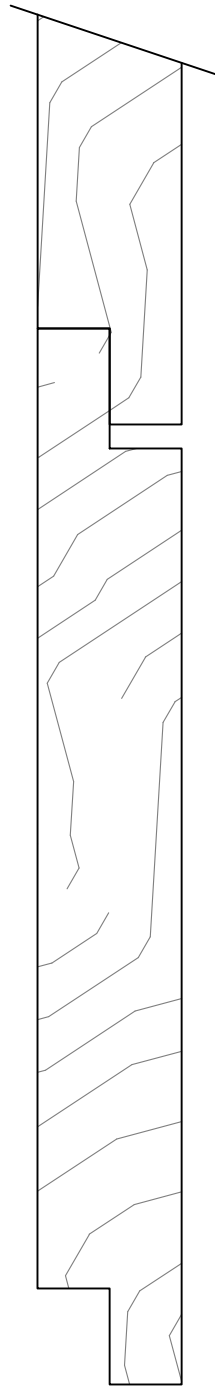

GCM7501  
3/4 x VARIES

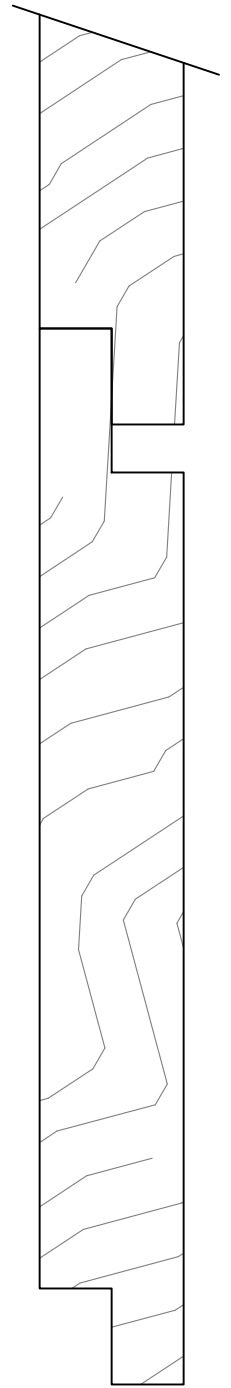

GCM3515  
3/4 x VARIES

# GRAYCO BUILDING CENTER

WWW.GRAYCOINC.COM

BLUFFTON  
345 BUCK ISLAND RD, BLUFFTON SC 29910  
(843) 815-5788 FAX 815-5799

LADY'S ISLAND  
20 SAMS POINT WAY, BEAUFORT SC 29907  
(843) 522-9994 FAX 522-9972

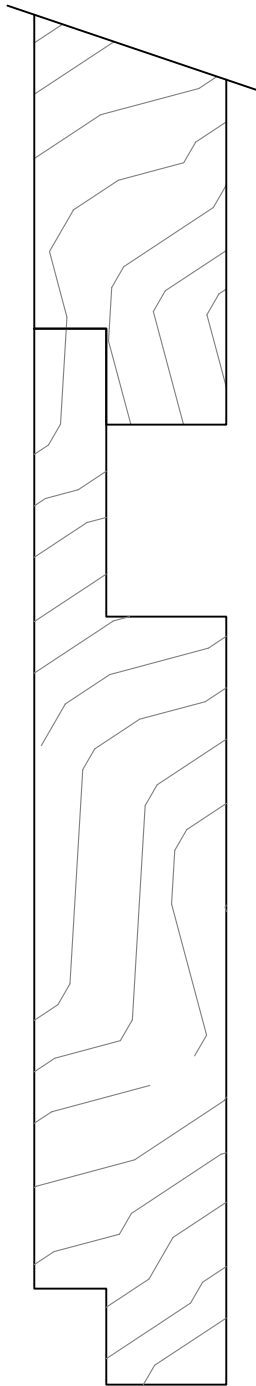

GCM3516  
1 x VARIES

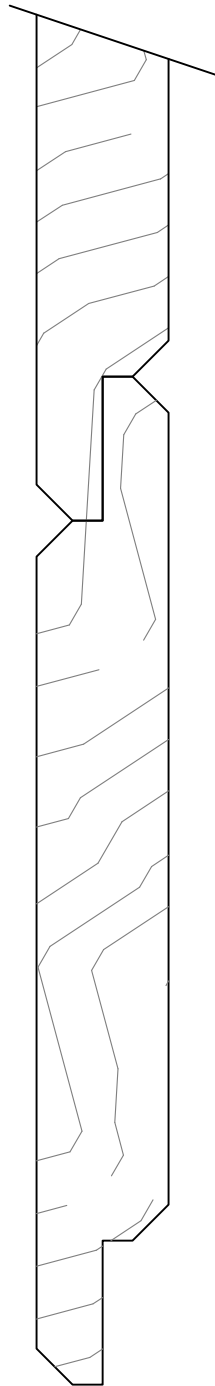

GCMSL525  
 $\frac{3}{4}$  x  $5\frac{1}{4}$

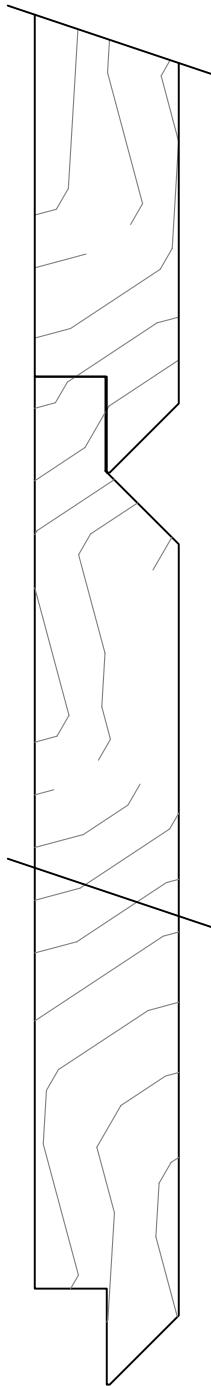

GCM3501  
 $\frac{3}{4}$  x  $7\frac{3}{4}$   
7 $\frac{1}{4}$ " FACE

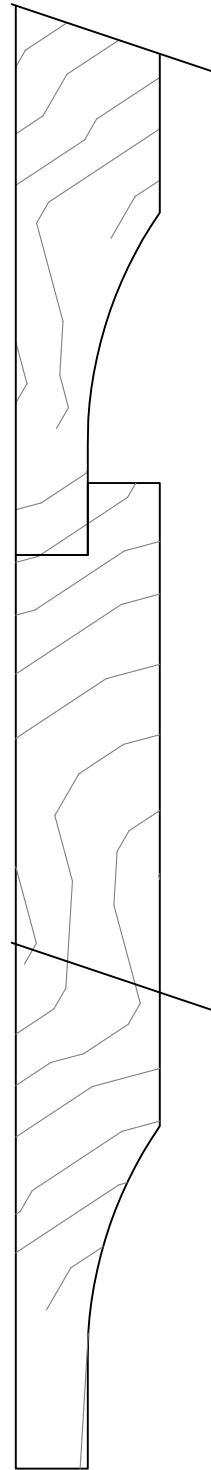

GCM7500  
 $\frac{3}{4}$  X  $7\frac{1}{2}$

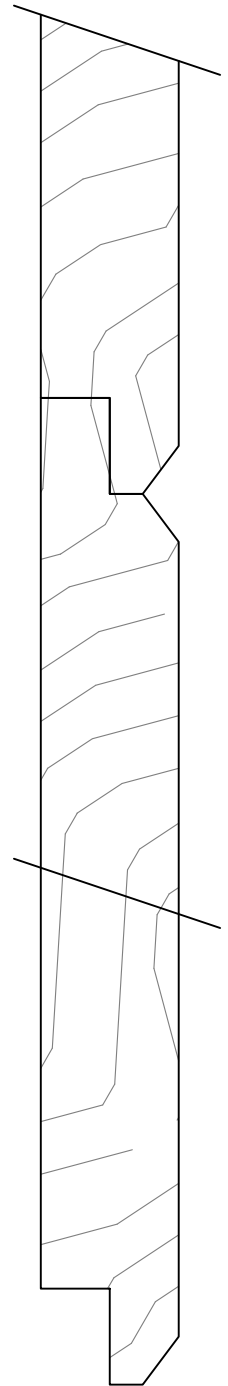

GCM121  
 $2\frac{3}{32}$  X VARIES

# GRAYCO BUILDING CENTER

WWW.GRAYCOINC.COM

BLUFFTON  
345 BUCK ISLAND RD, BLUFFTON SC 29910  
(843) 815-5788 FAX 815-5799

LADY'S ISLAND  
20 SAMS POINT WAY, BEAUFORT SC 29907  
(843) 522-9994 FAX 522-9972

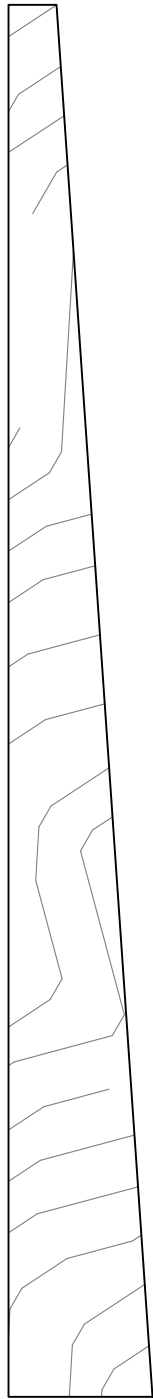

GCM7503  
3/4 X 7 1/4

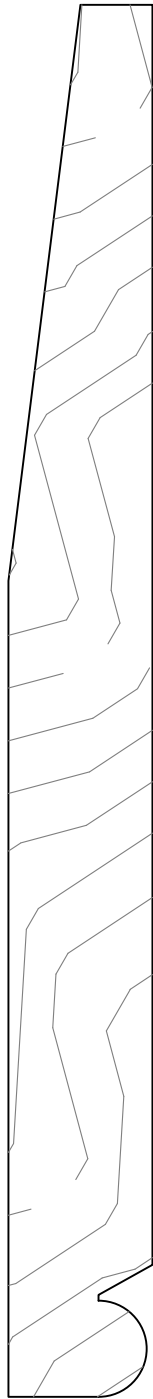

GCM145  
3/4 x 7 1/4  
6" FACE

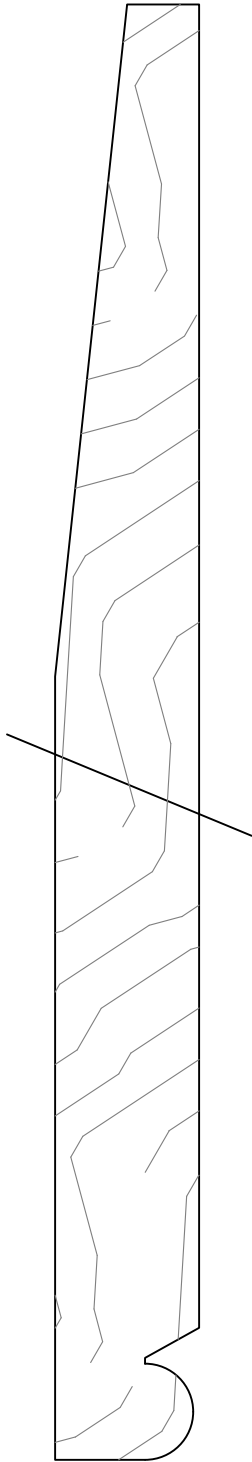

GCM145  
3/4 x 9 1/4  
7" FACE

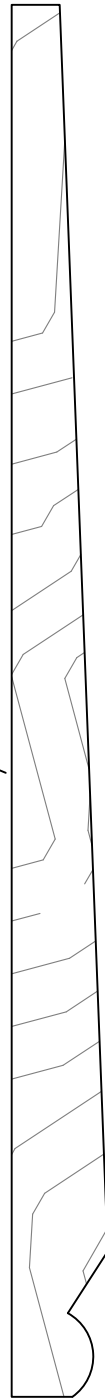

GCM7506  
1/2 X 7 1/4

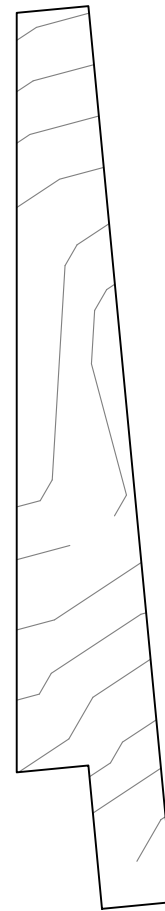

GCM7504  
3/4 X 4 1/16

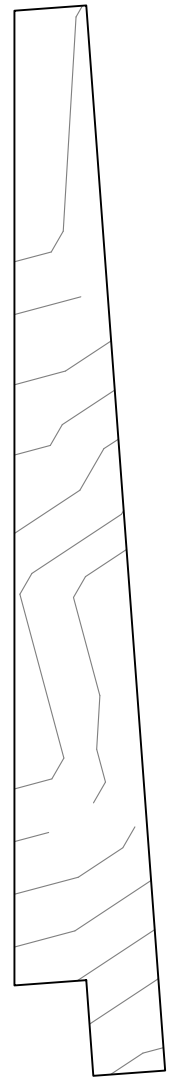

GCM7505  
3/4 X 5 9/16

# GRAYCO BUILDING CENTER

WWW.GRAYCOINC.COM

BLUFFTON  
345 BUCK ISLAND RD, BLUFFTON SC 29910  
(843) 815-5788 FAX 815-5799

LADY'S ISLAND  
20 SAMS POINT WAY, BEAUFORT SC 29907  
(843) 522-9994 FAX 522-9972

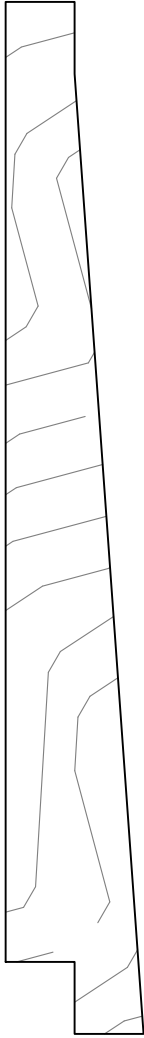

GCM119  
 $2\frac{3}{32}$  X  $5\frac{3}{8}$

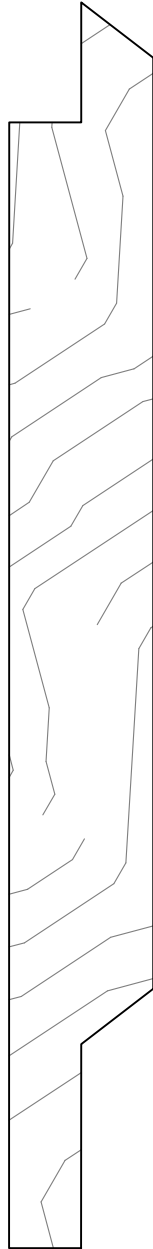

GCM7511  
 $\frac{3}{4}$  X VARIES

# GRAYCO BUILDING CENTER

[WWW.GRAYCOINC.COM](http://WWW.GRAYCOINC.COM)

BLUFFTON  
345 BUCK ISLAND RD, BLUFFTON SC 29910  
(843) 815-5788 FAX 815-5799

LADY'S ISLAND  
20 SAMS POINT WAY, BEAUFORT SC 29907  
(843) 522-9994 FAX 522-9972

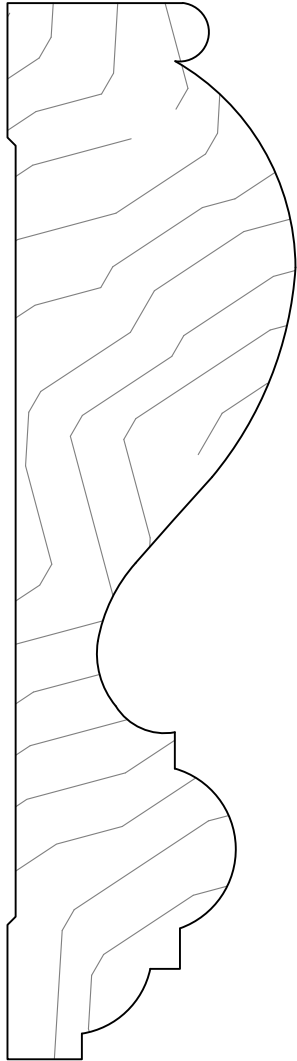

GCM20  
1½ x 5½

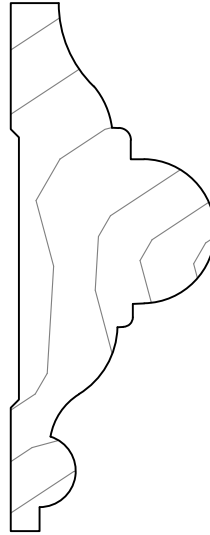

GCM300  
1⅛ x 2¾

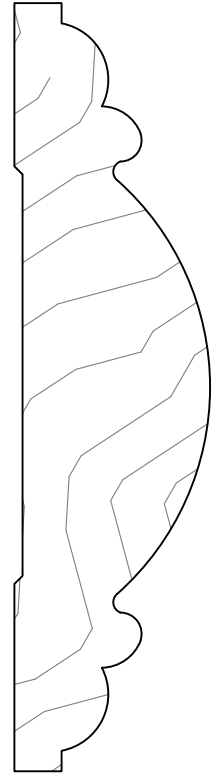

GCM395  
1 x 4

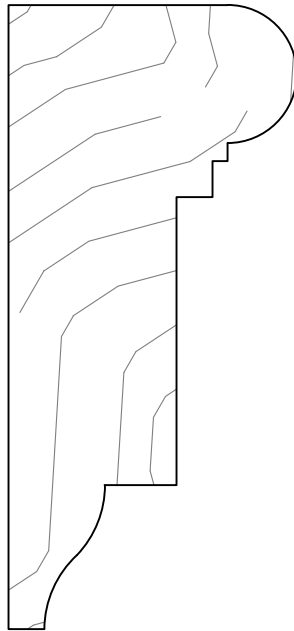

GCM1361  
1½ x 3¼

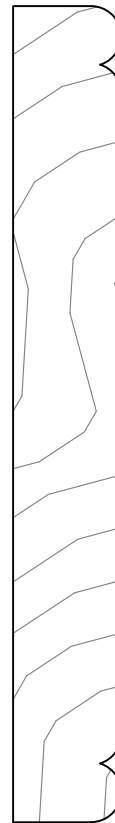

GCM304  
9/16 x 4¼

# GRAYCO BUILDING CENTER

WWW.GRAYCOINC.COM

BLUFFTON  
345 BUCK ISLAND RD, BLUFFTON SC 29910  
(843) 815-5788 FAX 815-5799

LADY'S ISLAND  
20 SAMS POINT WAY, BEAUFORT SC 29907  
(843) 522-9994 FAX 522-9972



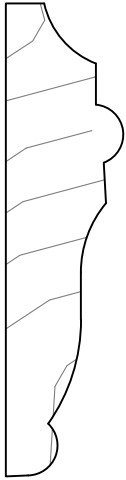

GCM12  
5/8 x 2 7/16

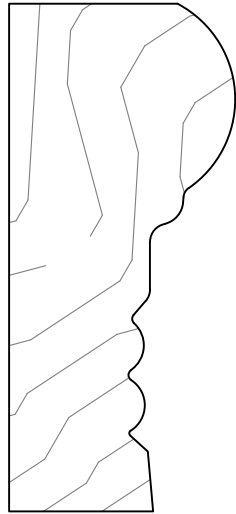

GCM5426  
1 3/16 x 2 5/8

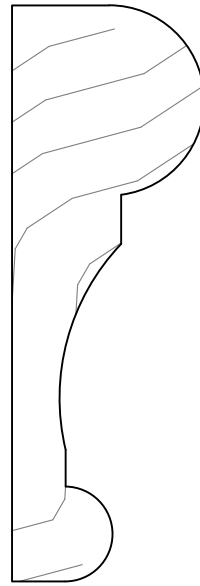

GCM7001  
1 x 3

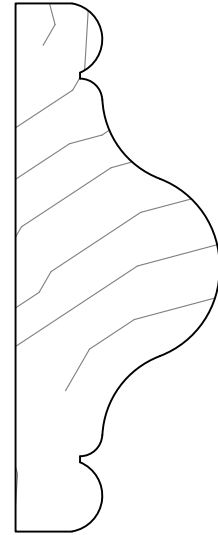

GCM302  
1 1/16 x 2 3/4

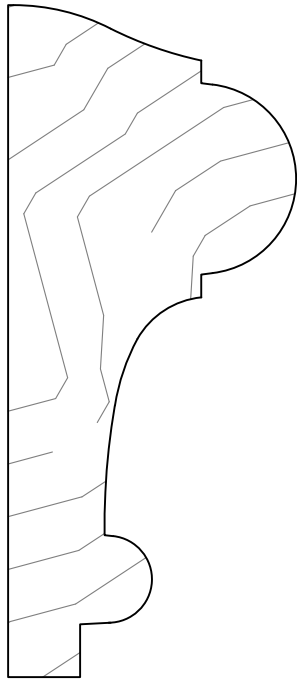

GCM5003  
1 1/2 x 3 1/2

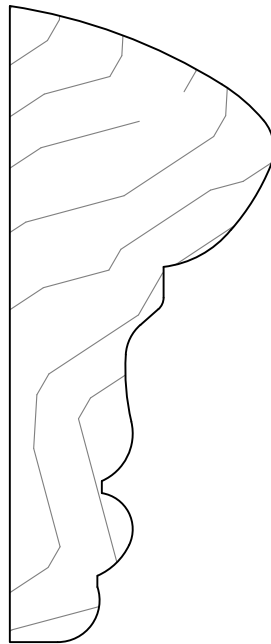

GCM7008  
1 3/8 x 3 5/16



GCM1022  
1" x 4"

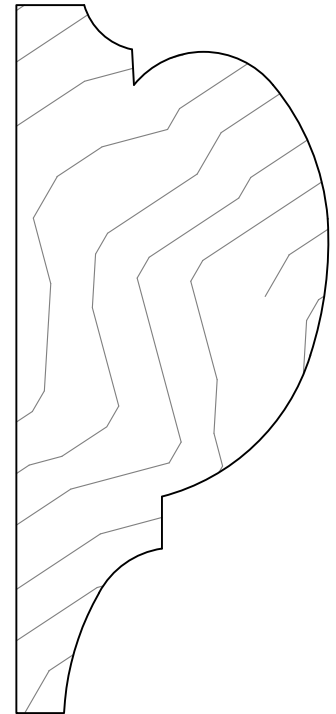

GCM6014  
1 5/8 x 3 1/16

# GRAYCO BUILDING CENTER

WWW.GRAYCOINC.COM

BLUFFTON  
345 BUCK ISLAND RD, BLUFFTON SC 29910  
(843) 815-5788 FAX 815-5799

LADY'S ISLAND  
20 SAMS POINT WAY, BEAUFORT SC 29907  
(843) 522-9994 FAX 522-9972

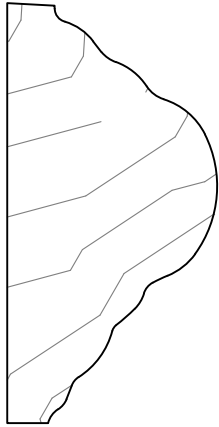

GCM7005  
1<sup>3</sup>/<sub>32</sub> X 2<sup>3</sup>/<sub>16</sub>"

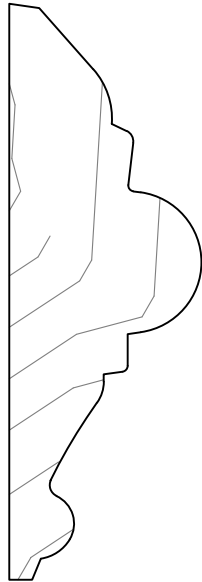

GCM7010  
1 X 3"

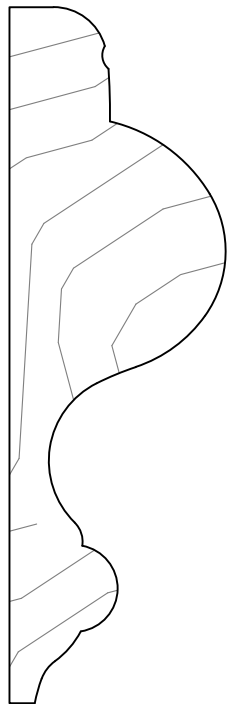

GCM5511  
1<sup>1</sup>/<sub>8</sub> X 3<sup>5</sup>/<sub>8</sub>

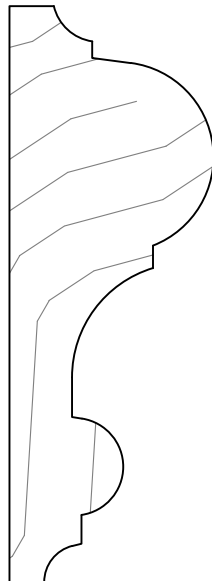

GCM7009  
1<sup>1</sup>/<sub>16</sub> X 3

# GRAYCO BUILDING CENTER

WWW.GRAYCOINC.COM

BLUFFTON  
345 BUCK ISLAND RD, BLUFFTON SC 29910  
(843) 815-5788 FAX 815-5799

LADY'S ISLAND  
20 SAMS POINT WAY, BEAUFORT SC 29907  
(843) 522-9994 FAX 522-9972

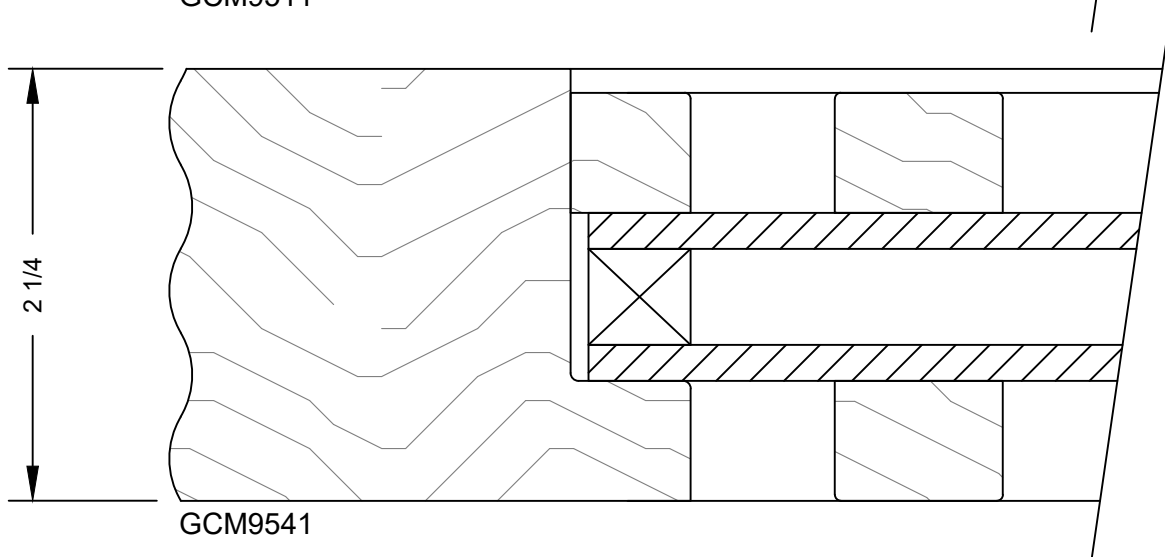
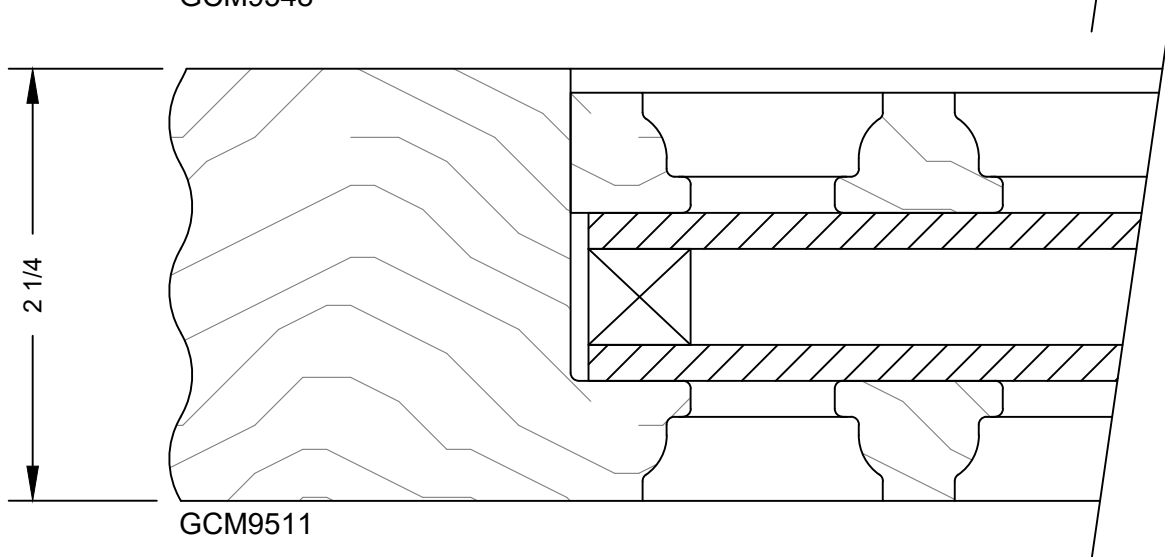
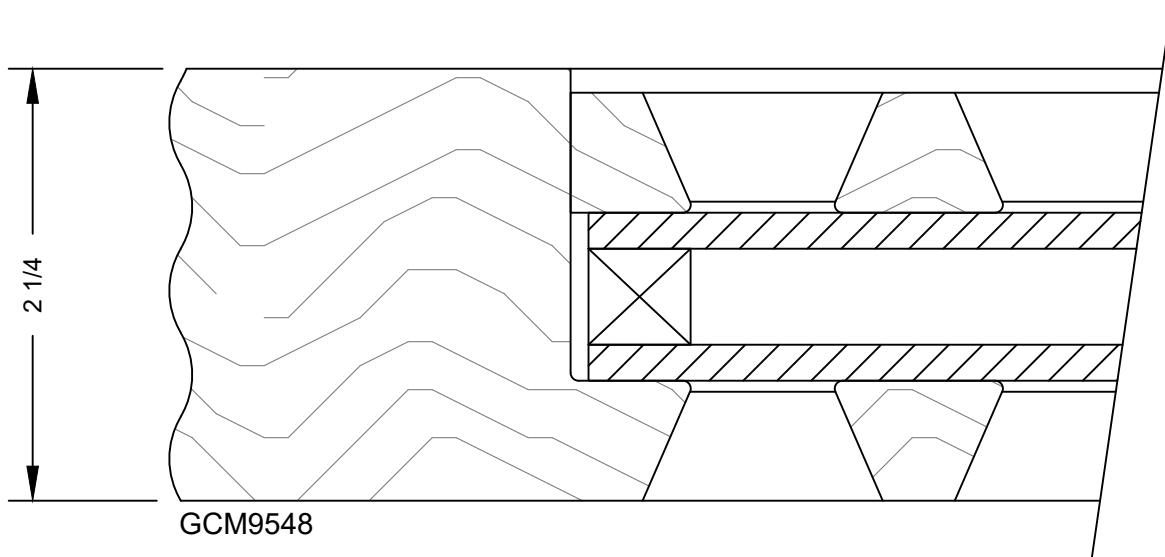

# GRAYCO BUILDING CENTER

WWW.GRAYCOINC.COM

BLUFFTON  
345 BUCK ISLAND RD, BLUFFTON SC 29910  
(843) 815-5788 FAX 815-5799

LADY'S ISLAND  
20 SAMS POINT WAY, BEAUFORT SC 29907  
(843) 522-9994 FAX 522-9972

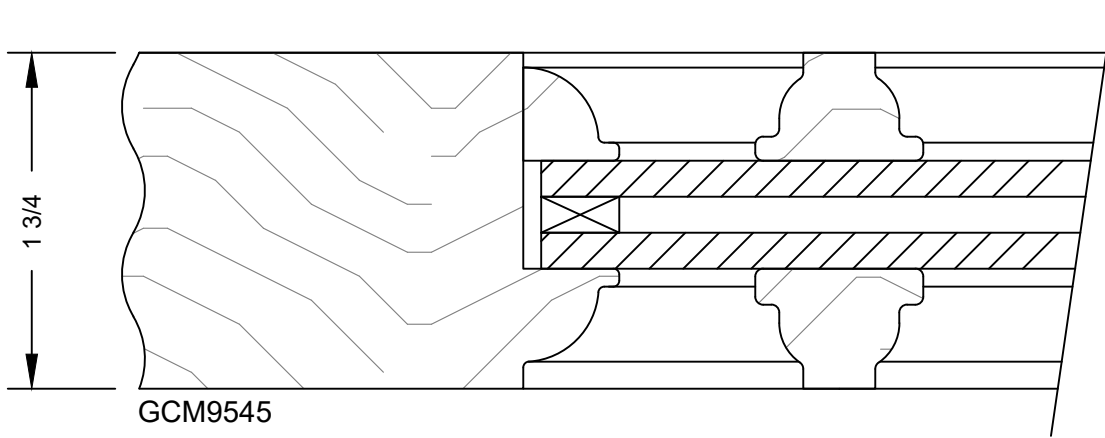

GCM9545

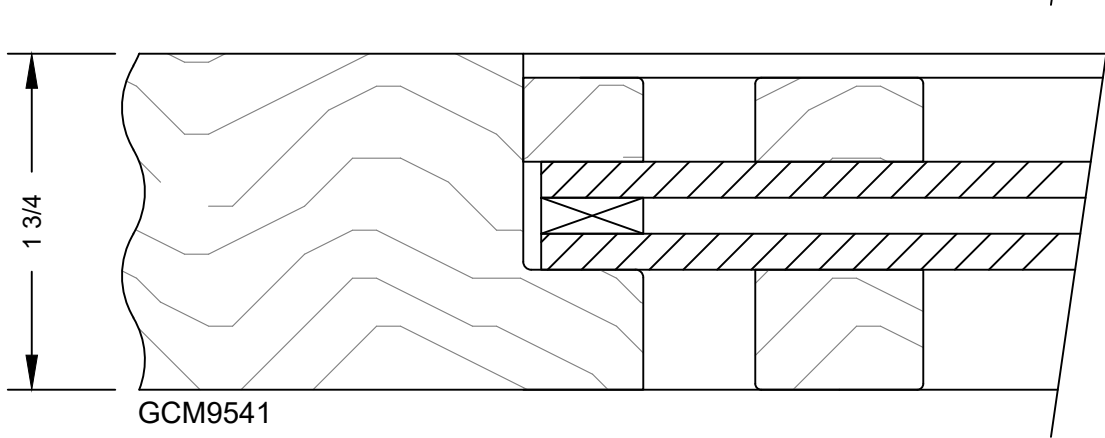

GCM9541

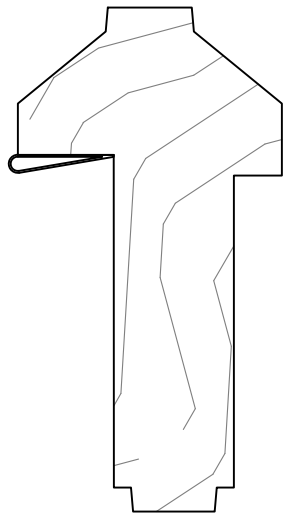

GCM9556

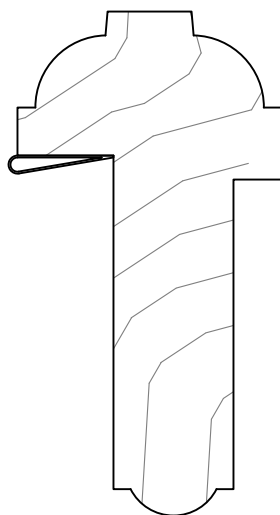

GCM9536

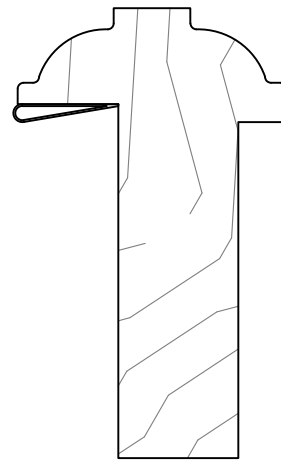

GCM6035

# GRAYCO BUILDING CENTER

WWW.GRAYCOINC.COM

BLUFFTON  
345 BUCK ISLAND RD, BLUFFTON SC 29910  
(843) 815-5788 FAX 815-5799

LADY'S ISLAND  
20 SAMS POINT WAY, BEAUFORT SC 29907  
(843) 522-9994 FAX 522-9972

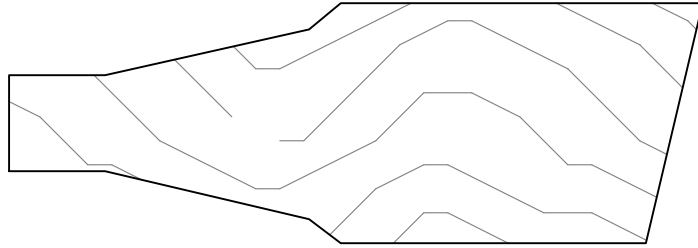

GCM9521

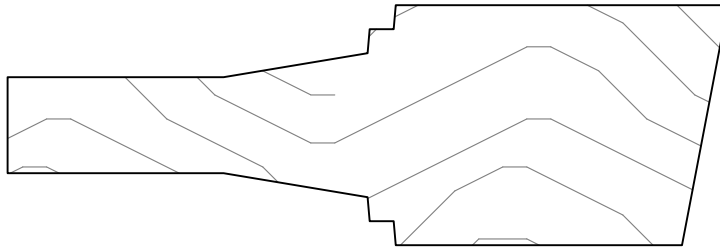

GCM9539

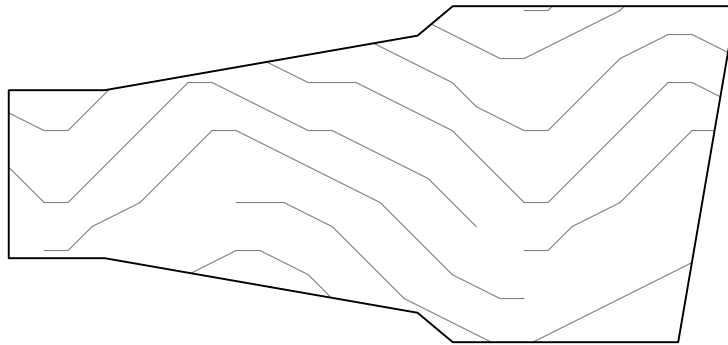

GCM9557

# GRAYCO BUILDING CENTER

[WWW.GRAYCOINC.COM](http://WWW.GRAYCOINC.COM)

BLUFFTON  
345 BUCK ISLAND RD, BLUFFTON SC 29910  
(843) 815-5788 FAX 815-5799

LADY'S ISLAND  
20 SAMS POINT WAY, BEAUFORT SC 29907  
(843) 522-9994 FAX 522-9972

# GRAYCO BUILDING CENTER

[WWW.GRAYCOINC.COM](http://WWW.GRAYCOINC.COM)

BLUFFTON  
345 BUCK ISLAND RD, BLUFFTON SC 29910  
(843) 815-5788 FAX 815-5799

LADY'S ISLAND  
20 SAMS POINT WAY, BEAUFORT SC 29907  
(843) 522-9994 FAX 522-9972

# GRAYCO BUILDING CENTER

[WWW.GRAYCOINC.COM](http://WWW.GRAYCOINC.COM)

BLUFFTON  
345 BUCK ISLAND RD, BLUFFTON SC 29910  
(843) 815-5788 FAX 815-5799

LADY'S ISLAND  
20 SAMS POINT WAY, BEAUFORT SC 29907  
(843) 522-9994 FAX 522-9972

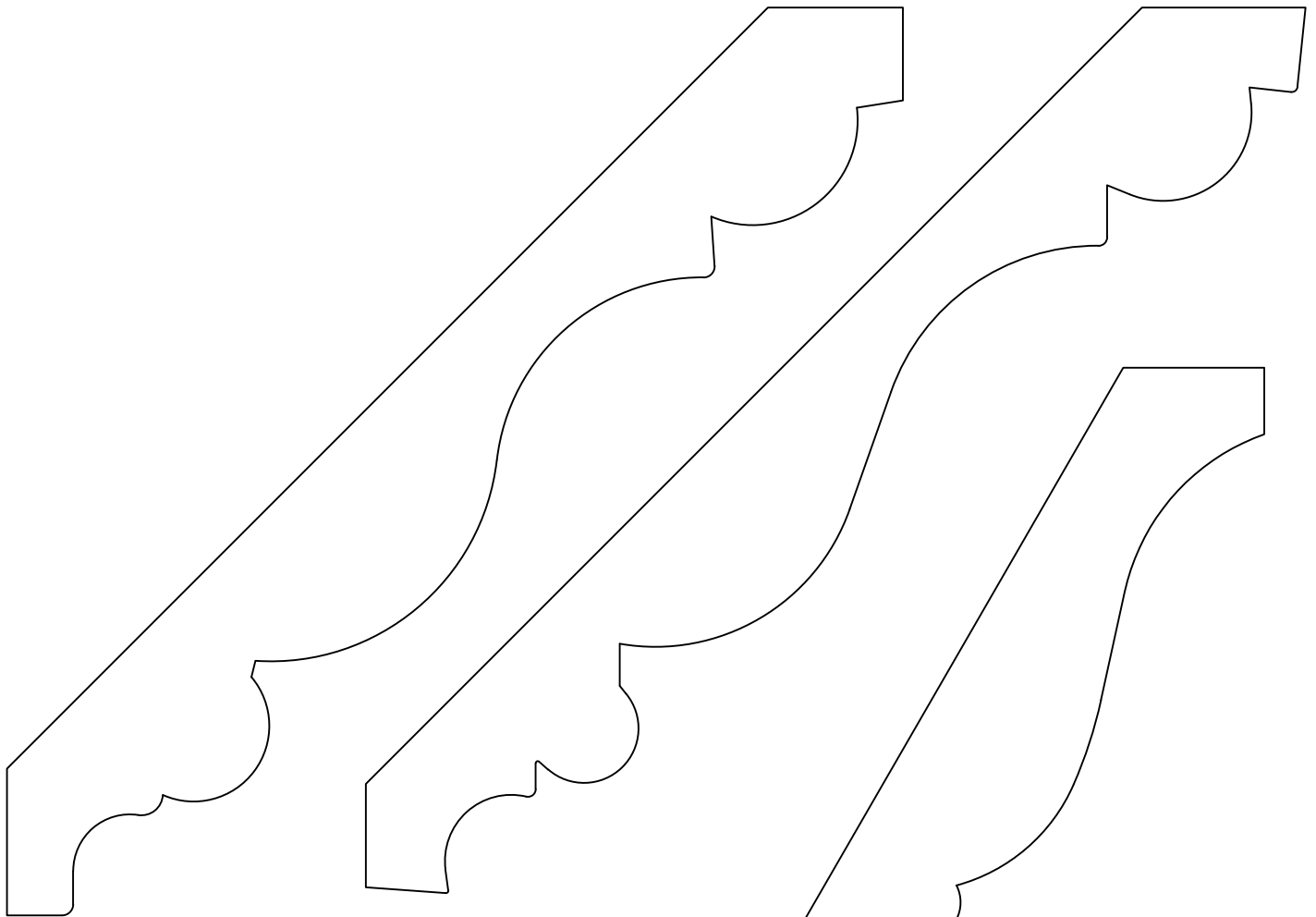

GCM636  
Projection  $5/16$   
Height  $5/8$   
 $3/4 \times 4 1/4$

GCM647  
Projection  $5/4$   
Height 5  
 $1 \times 7 1/4$

GCM945  
Projection  $3 3/16$   
Height  $5/16$   
 $1 5/16 \times 6$

# GRAYCO BUILDING CENTER

WWW.GRAYCOINC.COM

BLUFFTON  
345 BUCK ISLAND RD, BLUFFTON SC 29910  
(843) 815-5788 FAX 815-5799

LADY'S ISLAND  
20 SAMS POINT WAY, BEAUFORT SC 29907  
(843) 522-9994 FAX 522-9972



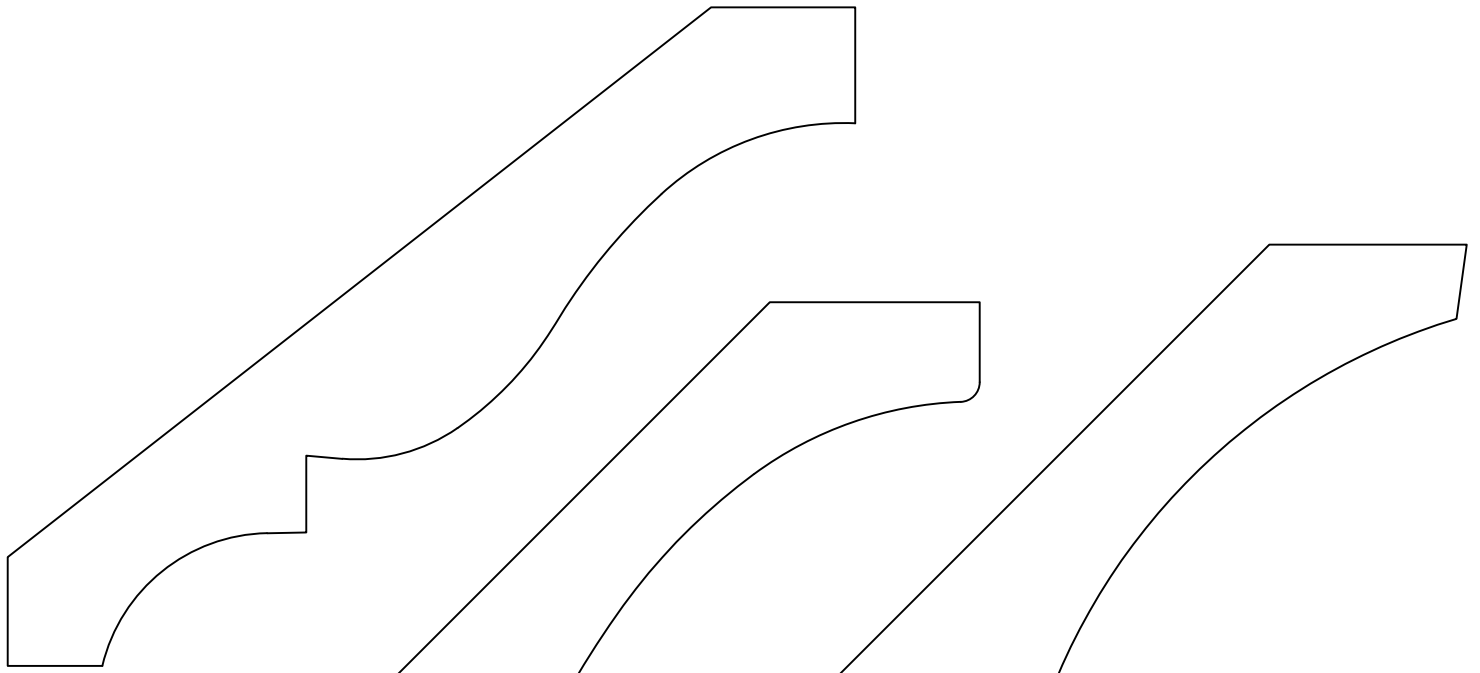

GCM660  
 Projection  $4\frac{7}{16}$   
 Height  $3\frac{7}{16}$   
 $1\frac{5}{16} \times 5\frac{5}{8}$

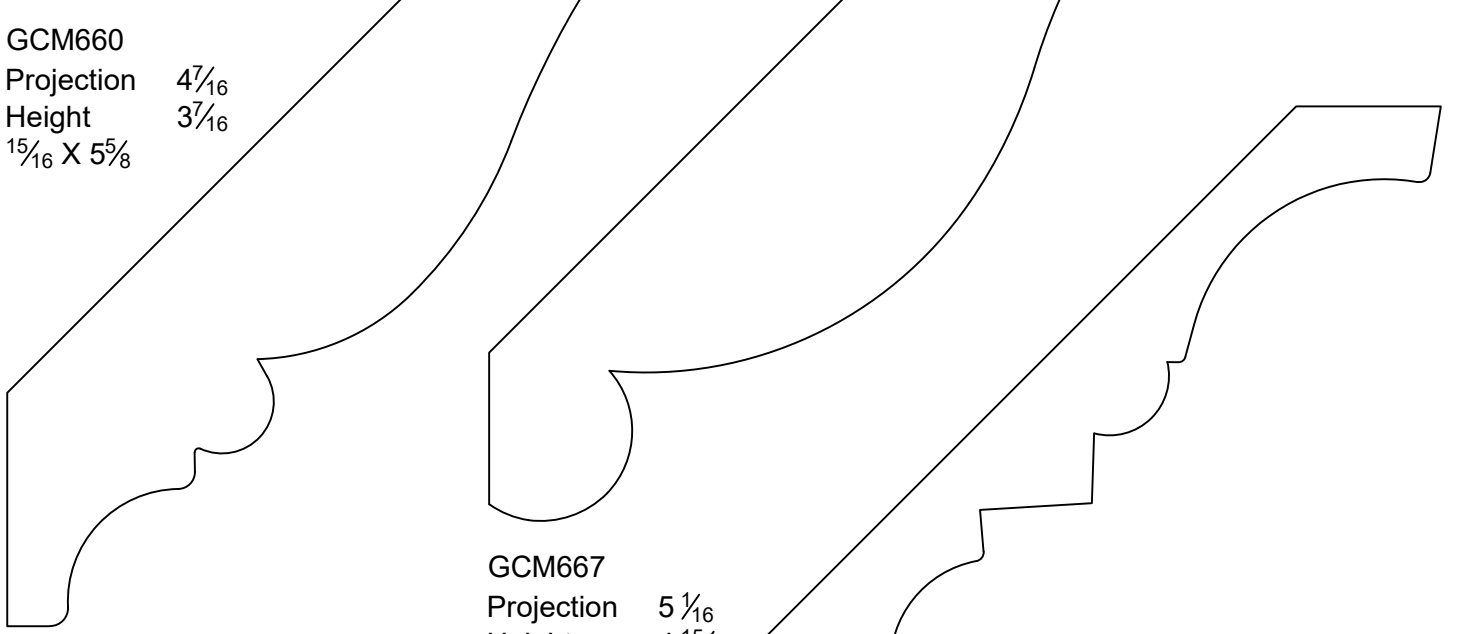

GCM661  
 Projection  $5\frac{1}{16}$   
 Height  $5\frac{3}{16}$   
 $1\frac{1}{8} \times 7\frac{1}{4}$

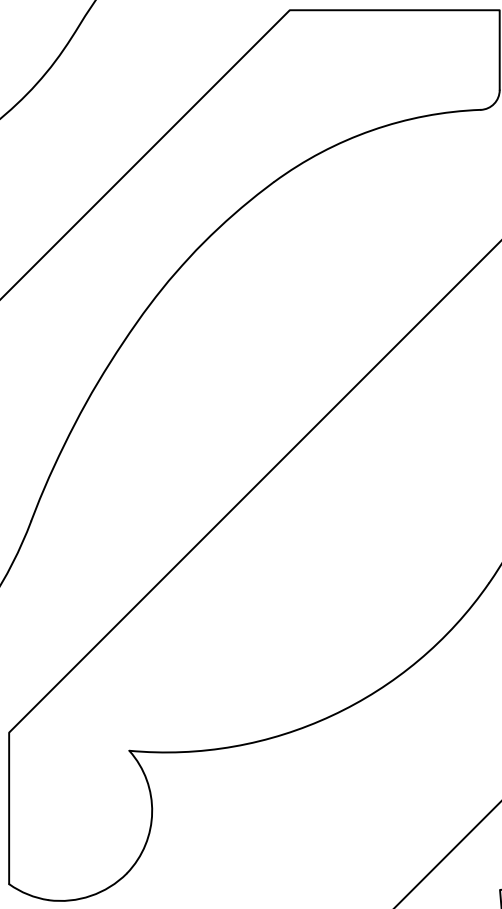

GCM667  
 Projection  $5\frac{1}{16}$   
 Height  $4\frac{15}{16}$   
 $1\frac{1}{4} \times 7$

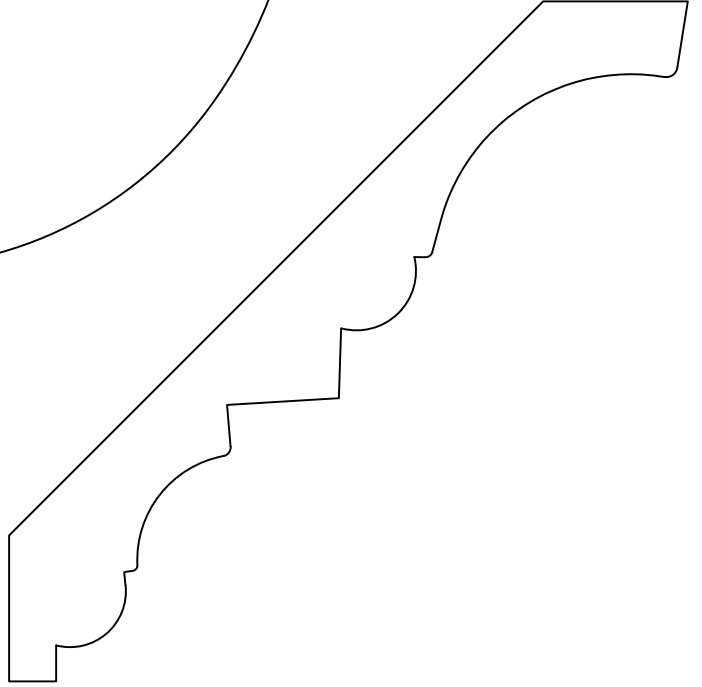

GCM659  
 Projection  $3\frac{9}{16}$   
 Height  $3\frac{9}{16}$   
 $\frac{3}{4} \times 5$

# GRAYCO BUILDING CENTER

WWW.GRAYCOINC.COM

BLUFFTON  
 345 BUCK ISLAND RD, BLUFFTON SC 29910  
 (843) 815-5788 FAX 815-5799

LADY'S ISLAND  
 20 SAMS POINT WAY, BEAUFORT SC 29907  
 (843) 522-9994 FAX 522-9972

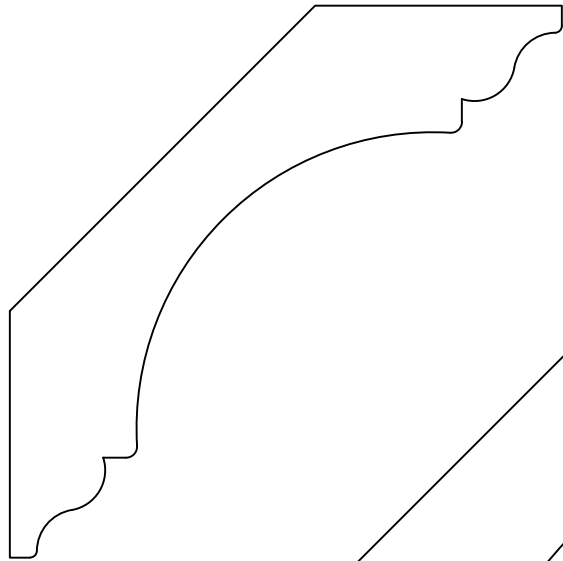

GCM637  
 Projection  $5\frac{1}{8}$   
 Height  $5\frac{1}{8}$   
 1 X  $7\frac{1}{4}$ "

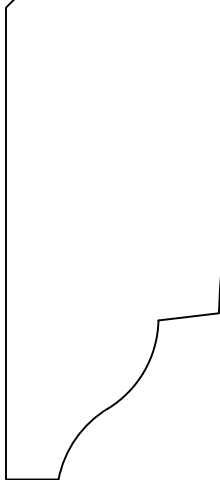

GCM658  
 Projection  $6\frac{1}{2}$   
 Height  $6\frac{1}{2}$   
 2 X  $9\frac{3}{16}$

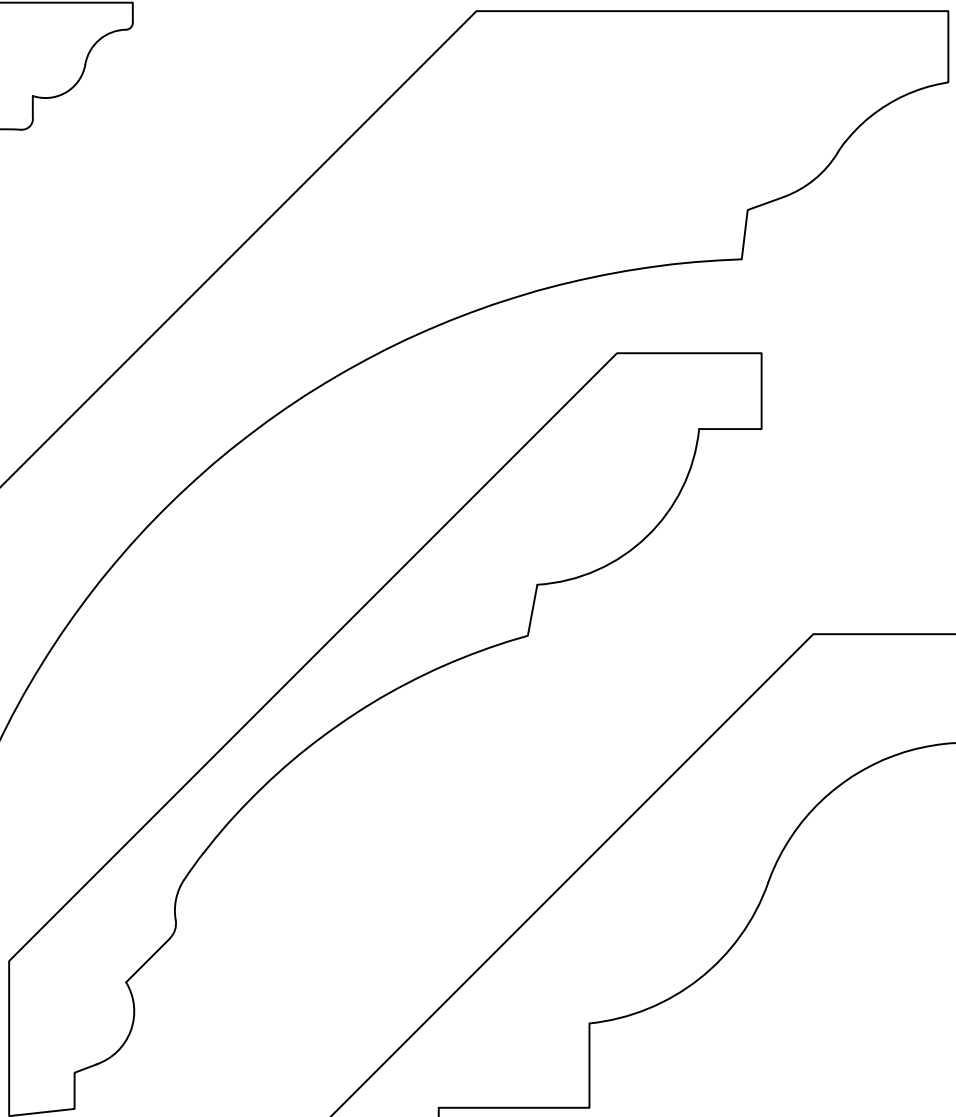

GCM642  
 Projection  $3\frac{15}{16}$   
 Height  $3\frac{15}{16}$   
 $1\frac{3}{16}$  X  $5\frac{5}{8}$

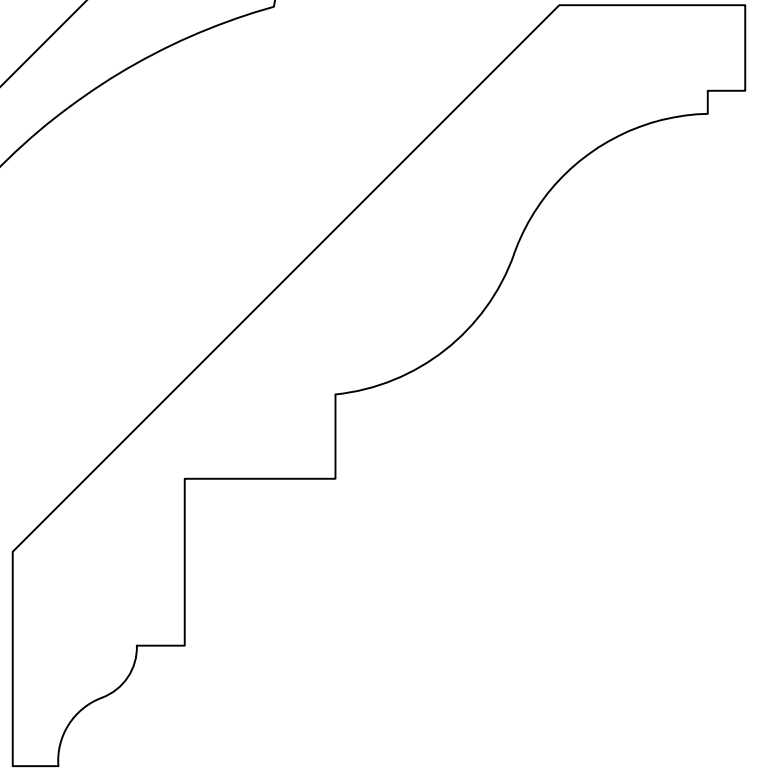

GCM643  
 Projection  $3\frac{13}{16}$   
 Height  $3\frac{15}{16}$   
 1 X  $5\frac{1}{2}$

# GRAYCO BUILDING CENTER

WWW.GRAYCOINC.COM

BLUFFTON  
 345 BUCK ISLAND RD, BLUFFTON SC 29910  
 (843) 815-5788 FAX 815-5799

LADY'S ISLAND  
 20 SAMS POINT WAY, BEAUFORT SC 29907  
 (843) 522-9994 FAX 522-9972

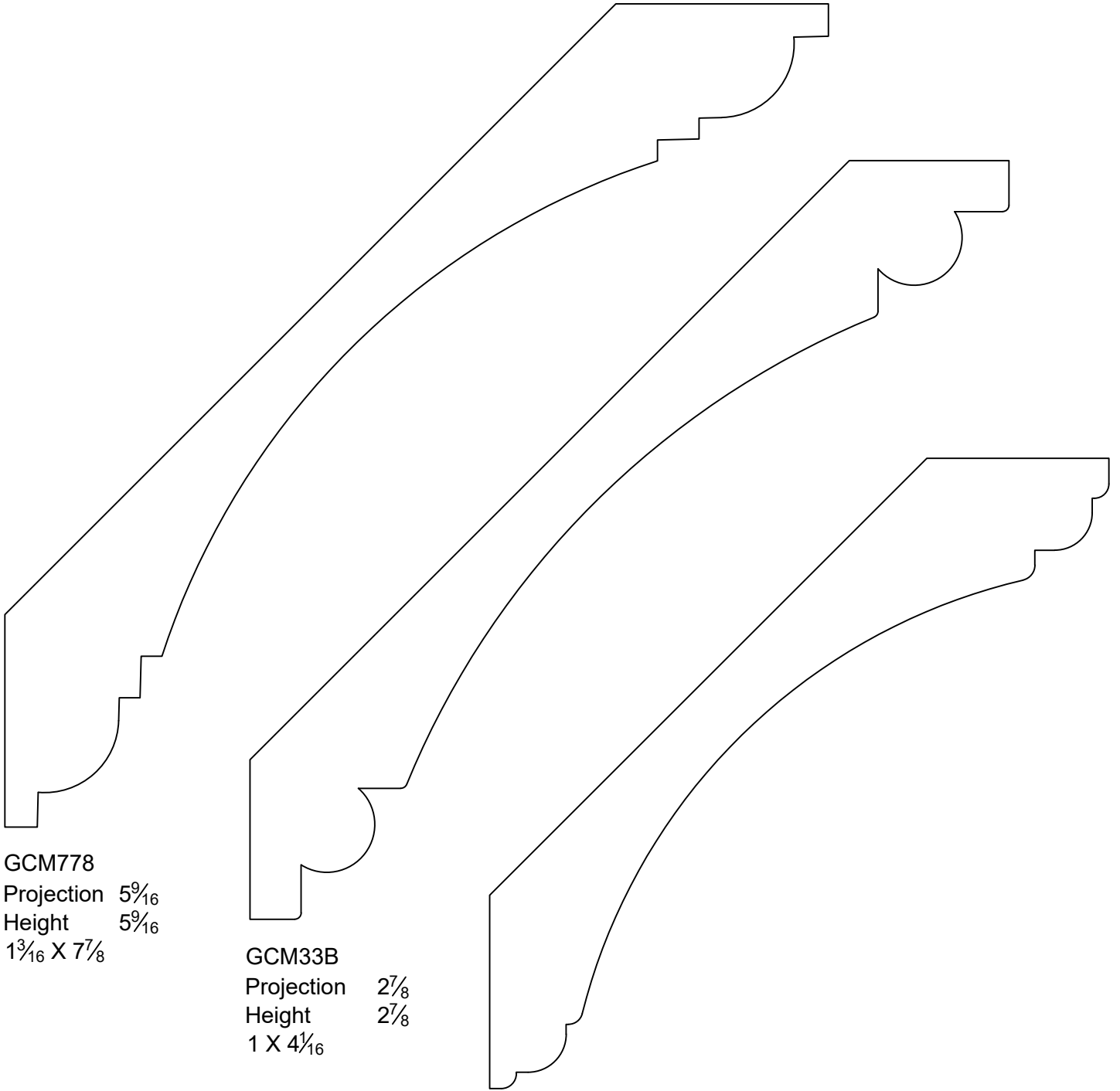

GCM778  
Projection  $5\frac{9}{16}$   
Height  $5\frac{9}{16}$   
 $1\frac{3}{16} \times 7\frac{7}{8}$

GCM33B  
Projection  $2\frac{7}{8}$   
Height  $2\frac{7}{8}$   
 $1 \times 4\frac{1}{16}$

GCM639  
Projection  $4\frac{3}{16}$   
Height  $4\frac{1}{2}$   
 $1\frac{1}{8} \times 6$

# GRAYCO BUILDING CENTER

WWW.GRAYCOINC.COM

BLUFFTON  
345 BUCK ISLAND RD, BLUFFTON SC 29910  
(843) 815-5788 FAX 815-5799

LADY'S ISLAND  
20 SAMS POINT WAY, BEAUFORT SC 29907  
(843) 522-9994 FAX 522-9972

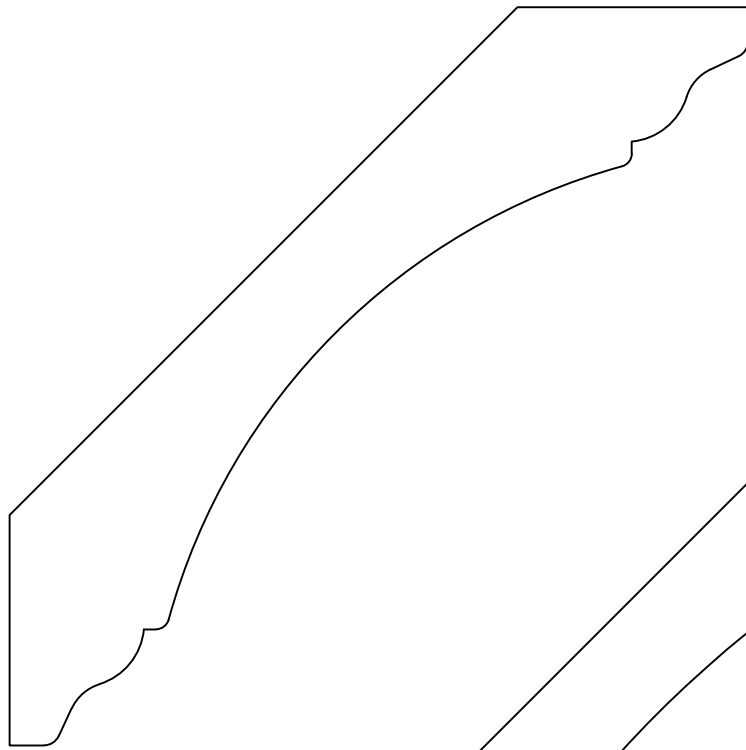

GCM640  
Projection  $3\frac{7}{8}$   
Height  $3\frac{7}{8}$   
 $1 \times 5\frac{7}{16}$

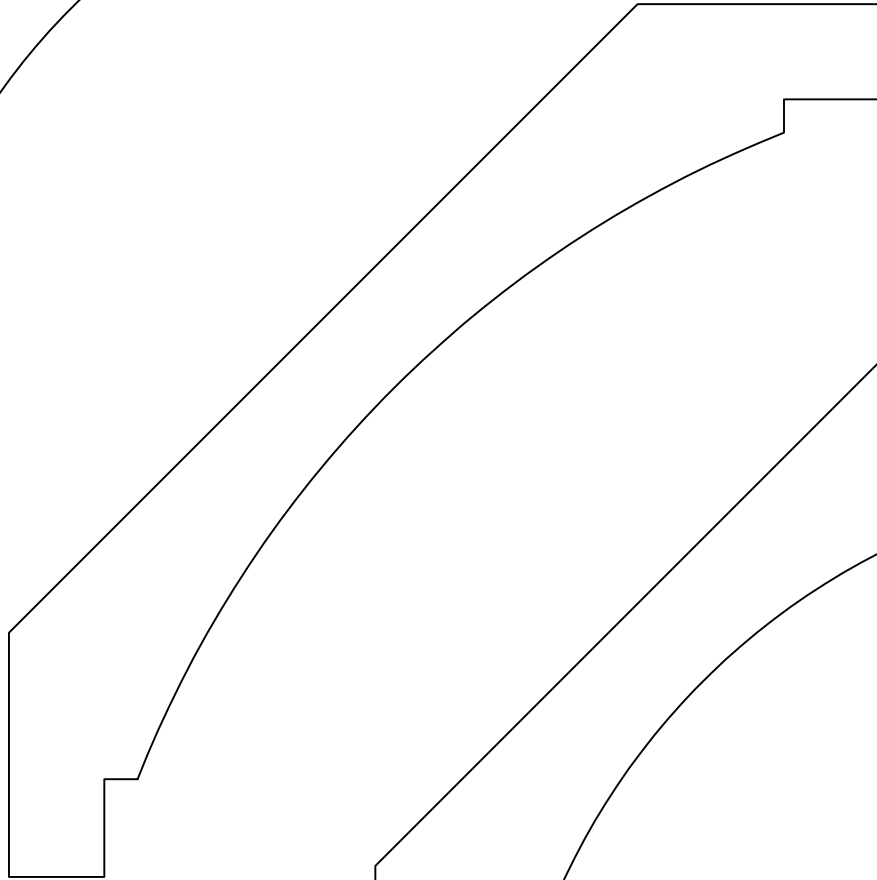

GCM656  
Projection  $4\frac{9}{16}$   
Height  $4\frac{9}{16}$   
 $1\frac{1}{4} \times 6\frac{7}{16}$

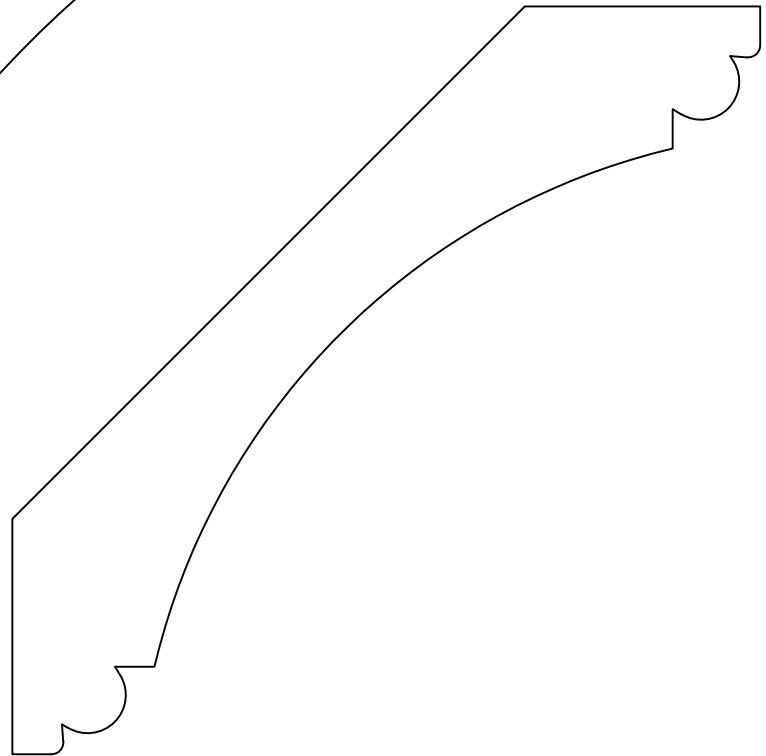

GCM654  
Projection  $3\frac{15}{16}$   
Height  $3\frac{15}{16}$   
 $1\frac{1}{8} \times 5\frac{1}{2}$

# GRAYCO BUILDING CENTER

WWW.GRAYCOINC.COM

BLUFFTON  
345 BUCK ISLAND RD, BLUFFTON SC 29910  
(843) 815-5788 FAX 815-5799

LADY'S ISLAND  
20 SAMS POINT WAY, BEAUFORT SC 29907  
(843) 522-9994 FAX 522-9972

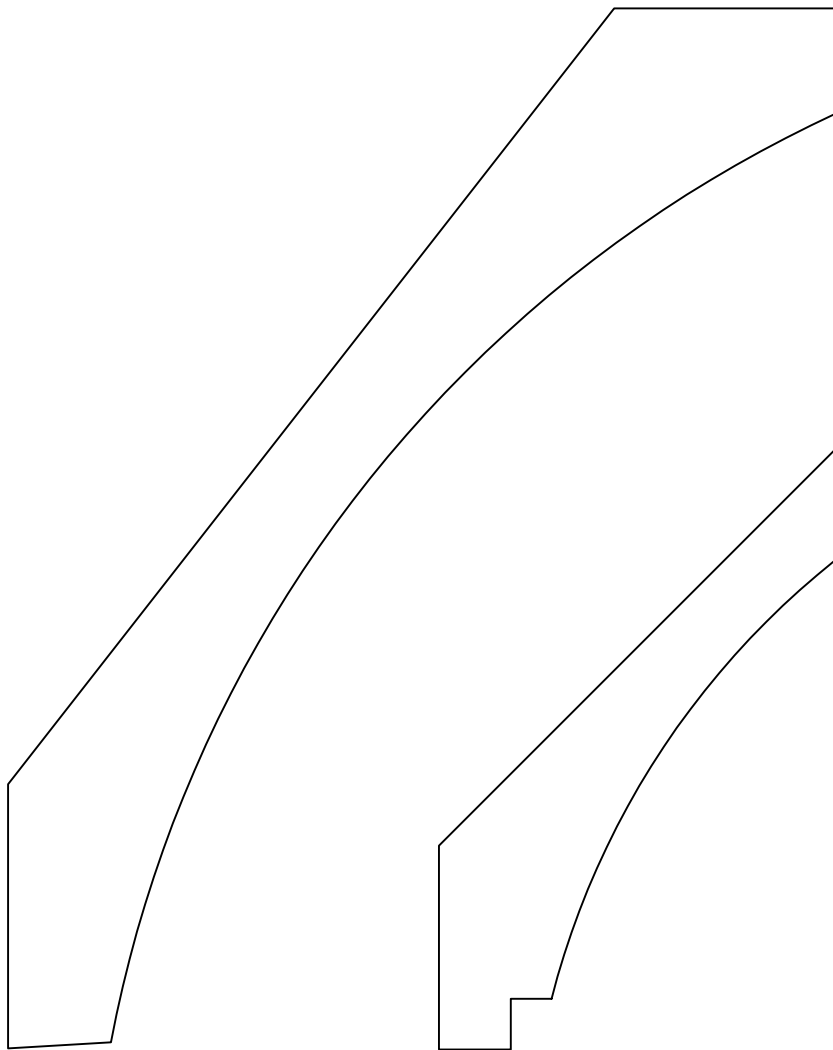

GCM657  
Projection  $4\frac{5}{16}$   
Height  $5\frac{7}{16}$   
 $1\frac{1}{4} \times 6\frac{15}{16}$

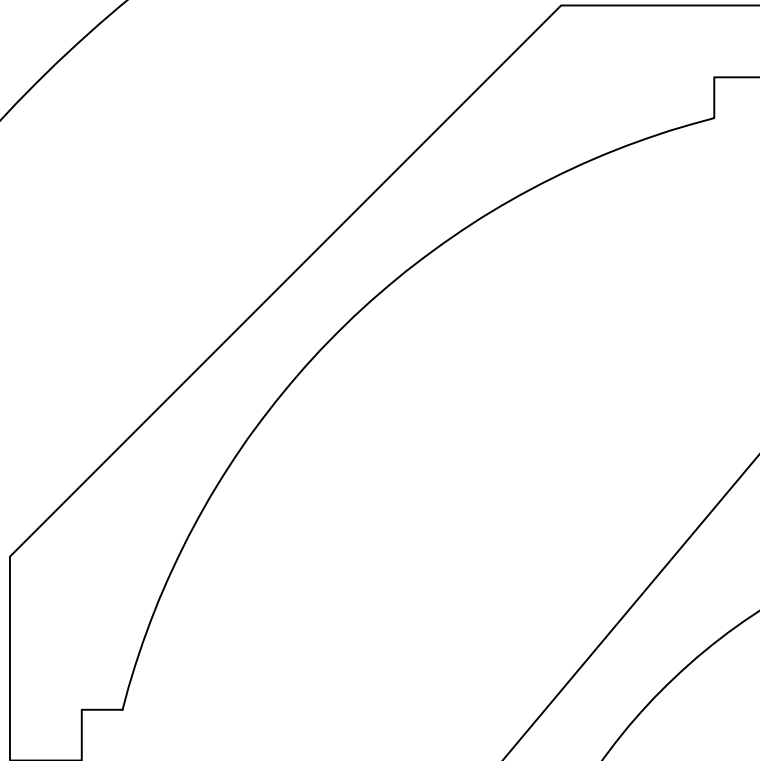

GCM662  
Projection  $3\frac{15}{16}$   
Height  $3\frac{15}{16}$   
 $1 \times 5\frac{9}{16}$

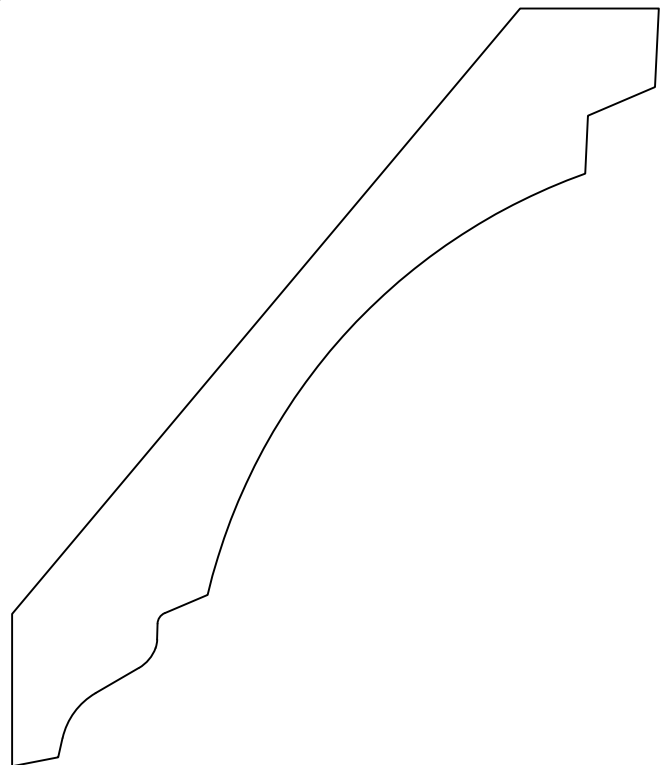

GCM653  
Projection  $3\frac{3}{8}$   
Height  $3\frac{15}{16}$   
 $1\frac{3}{16} \times 5\frac{3}{16}$

# GRAYCO BUILDING CENTER

WWW.GRAYCOINC.COM

BLUFFTON  
345 BUCK ISLAND RD, BLUFFTON SC 29910  
(843) 815-5788 FAX 815-5799

LADY'S ISLAND  
20 SAMS POINT WAY, BEAUFORT SC 29907  
(843) 522-9994 FAX 522-9972

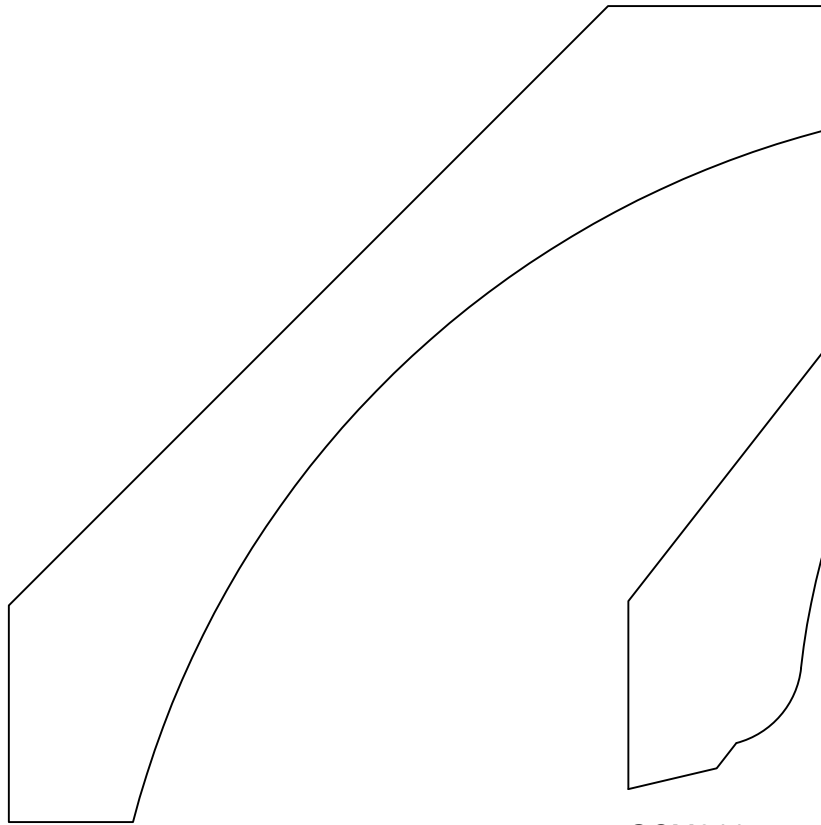

GCM648  
 Projection  $4\frac{1}{4}$   
 Height  $4\frac{1}{4}$   
 $1\frac{1}{4} \times 6$

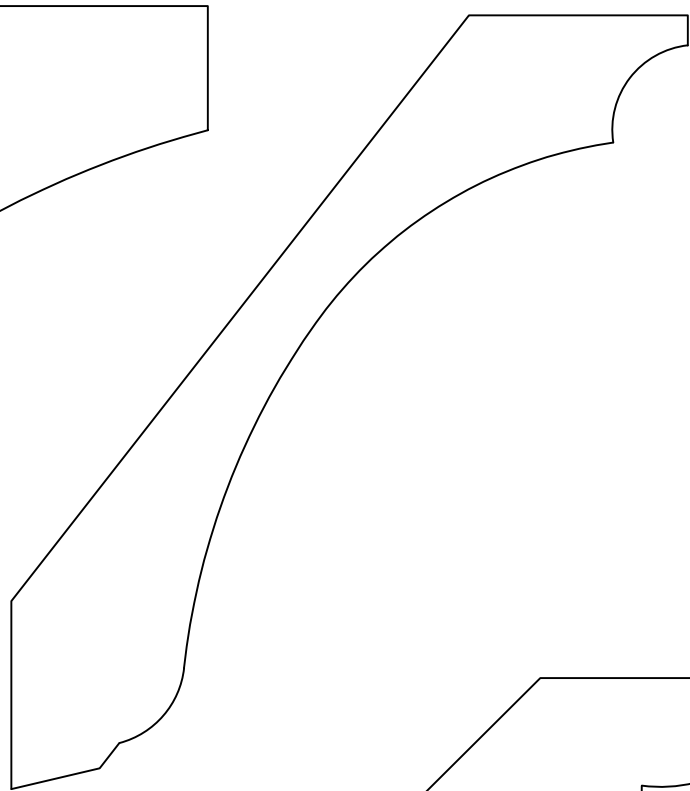

GCM644  
 Projection  $3\frac{1}{2}$   
 Height 4  
 $1 \times 5\frac{3}{8}$

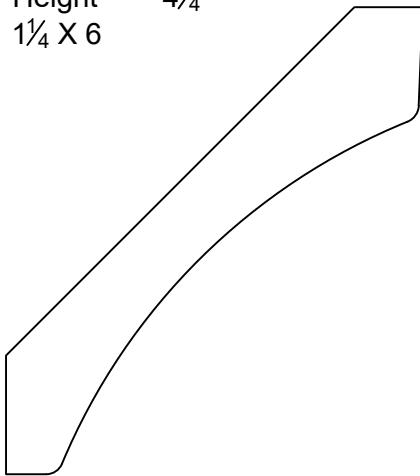

GCM652  
 Projection  $2\frac{3}{16}$   
 Height  $2\frac{7}{16}$   
 $\frac{5}{8} \times 3\frac{1}{4}$

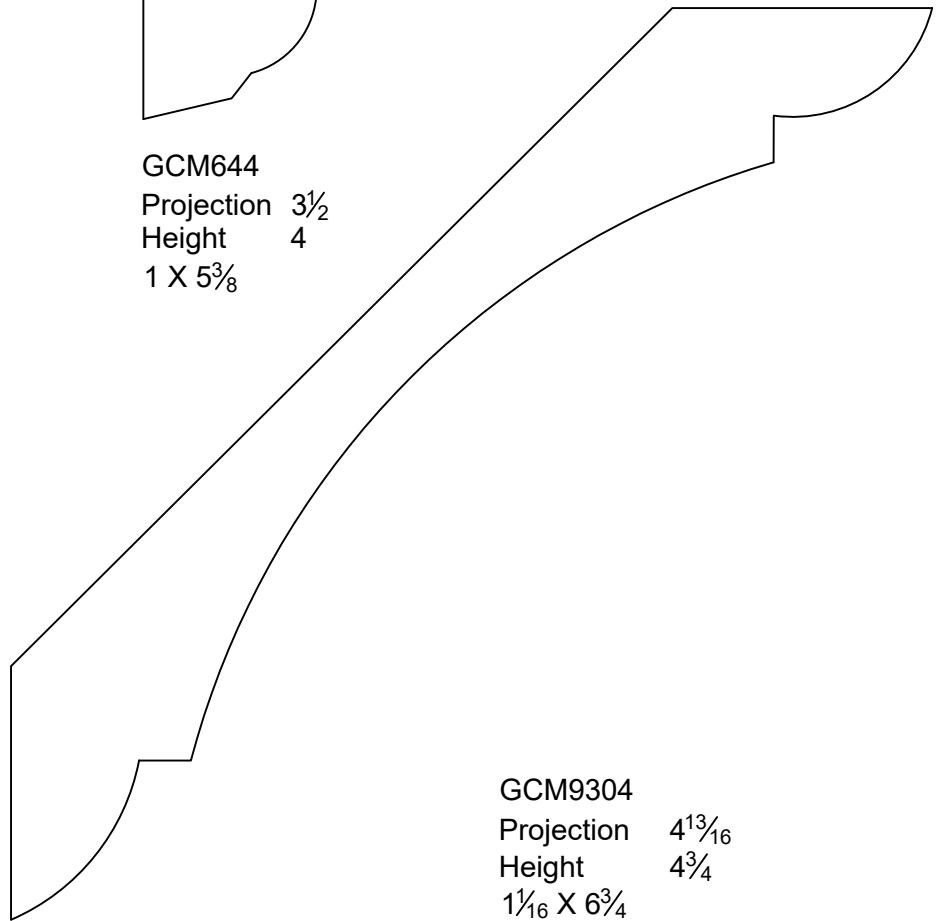

GCM9304  
 Projection  $4\frac{13}{16}$   
 Height  $4\frac{3}{4}$   
 $1\frac{1}{16} \times 6\frac{3}{4}$

# GRAYCO BUILDING CENTER

WWW.GRAYCOINC.COM

BLUFFTON  
 345 BUCK ISLAND RD, BLUFFTON SC 29910  
 (843) 815-5788 FAX 815-5799

LADY'S ISLAND  
 20 SAMS POINT WAY, BEAUFORT SC 29907  
 (843) 522-9994 FAX 522-9972

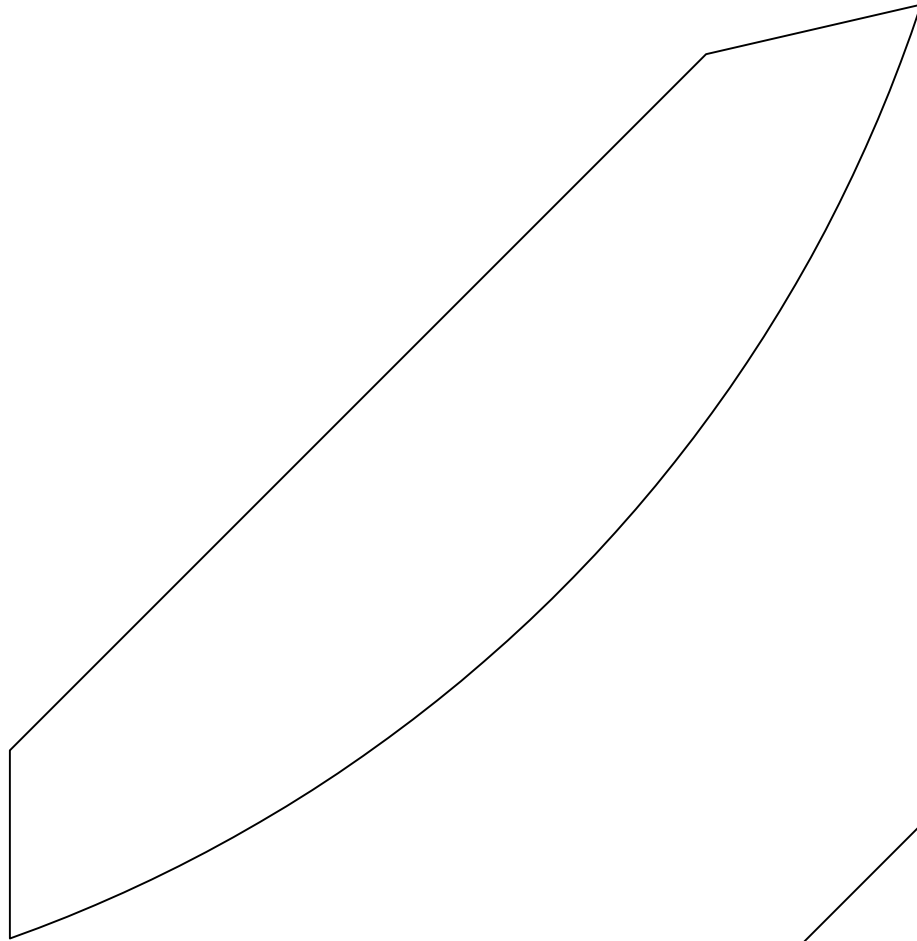

GCM651  
Projection  $4\frac{3}{4}$   
Height  $4\frac{7}{8}$   
 $1\frac{7}{16} \times 6\frac{13}{16}$

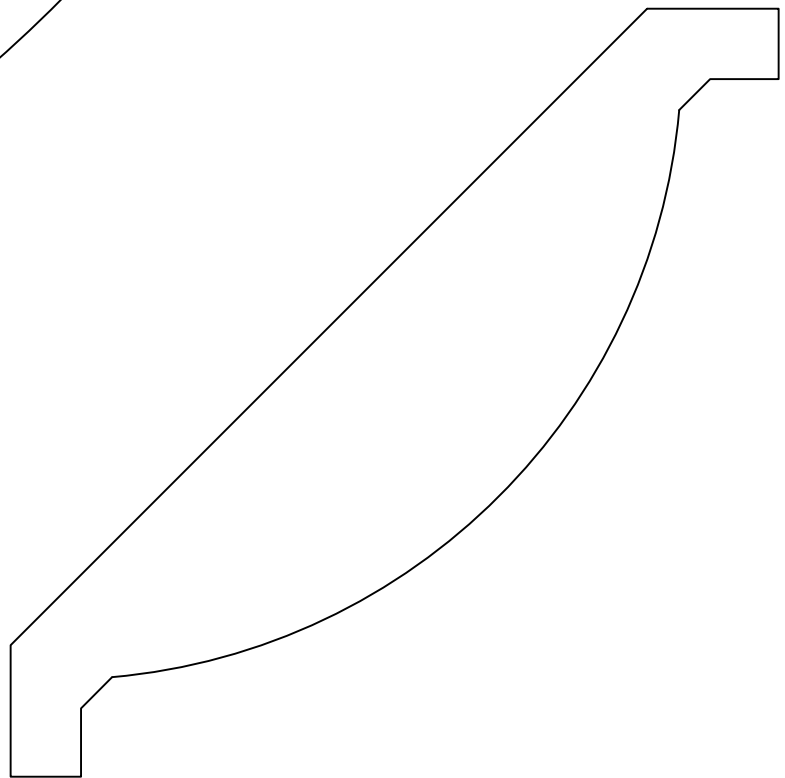

GCM638  
Projection 4  
Height 4  
 $1\frac{1}{4} \times 5\frac{5}{8}$

# GRAYCO BUILDING CENTER

[WWW.GRAYCOINC.COM](http://WWW.GRAYCOINC.COM)

BLUFFTON  
345 BUCK ISLAND RD, BLUFFTON SC 29910  
(843) 815-5788 FAX 815-5799

LADY'S ISLAND  
20 SAMS POINT WAY, BEAUFORT SC 29907  
(843) 522-9994 FAX 522-9972

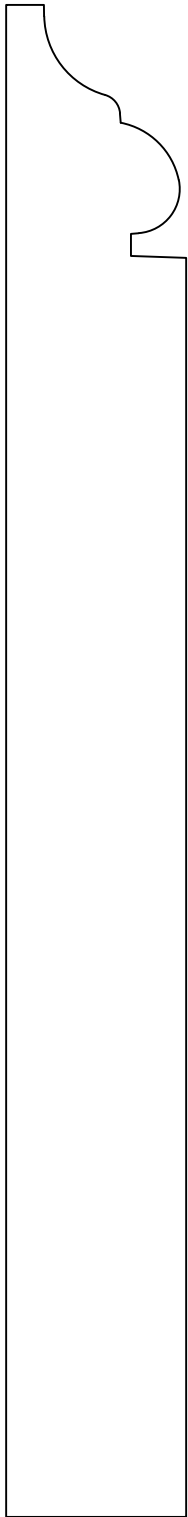

GCM1555  
15/16 X 7 7/8

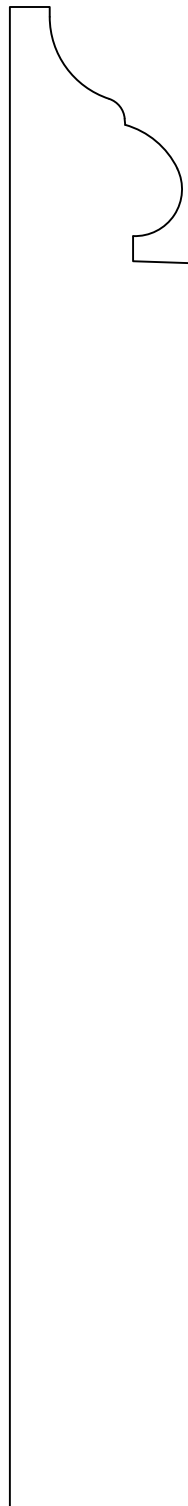

GCM1558  
15/16 X 7 13/16



GCM1552  
1 1/16 X 7 5/16

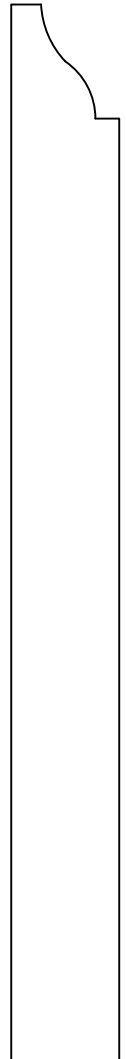

GCM620  
9/16 X 5 1/2

# GRAYCO BUILDING CENTER

WWW.GRAYCOINC.COM

BLUFFTON  
345 BUCK ISLAND RD, BLUFFTON SC 29910  
(843) 815-5788 FAX 815-5799

LADY'S ISLAND  
20 SAMS POINT WAY, BEAUFORT SC 29907  
(843) 522-9994 FAX 522-9972



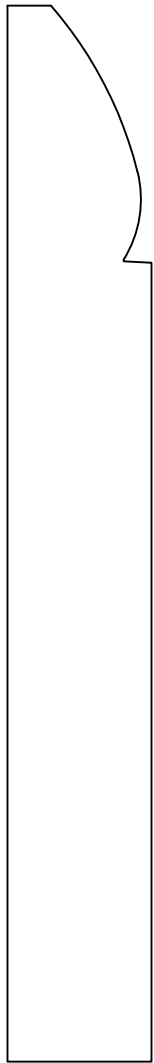

GCM1551  
3/4 X 5 1/2



GCM1553  
3/4 X 7 1/4

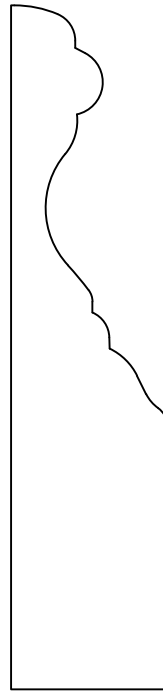

GCM1554  
1 3/16 X 3 9/16



GCM1193  
1 1/8 X 4 1/4

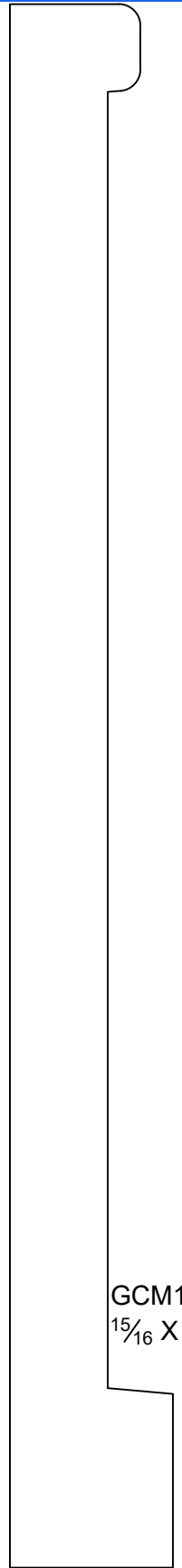

GCM1557  
1 5/16 X 9

# GRAYCO BUILDING CENTER

WWW.GRAYCOINC.COM

BLUFFTON  
345 BUCK ISLAND RD, BLUFFTON SC 29910  
(843) 815-5788 FAX 815-5799

LADY'S ISLAND  
20 SAMS POINT WAY, BEAUFORT SC 29907  
(843) 522-9994 FAX 522-9972

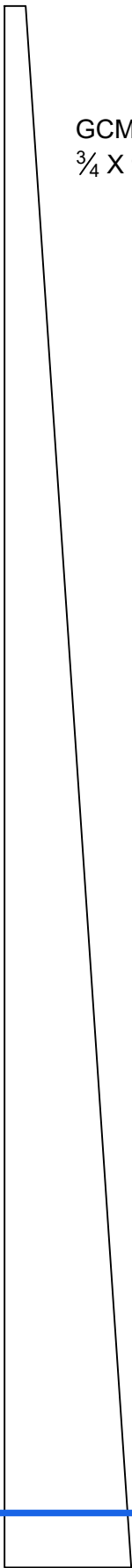

GCM7512  
3/4 X 9/4

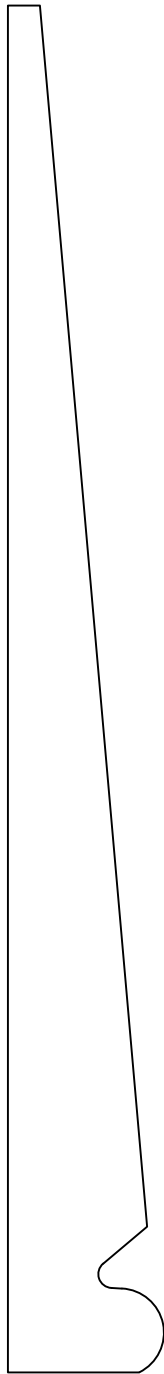

GCM7513  
13/16 X 7 1/8



GCM7516  
3/4 X 8 7/8

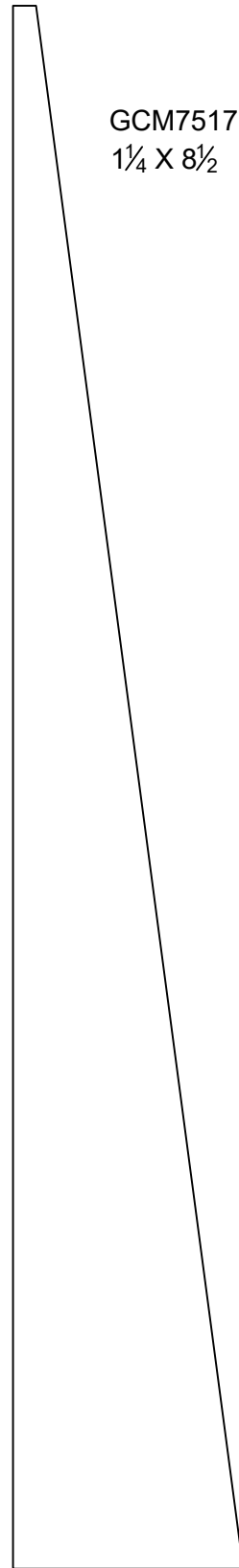

GCM7517  
1 1/4 X 8 1/2

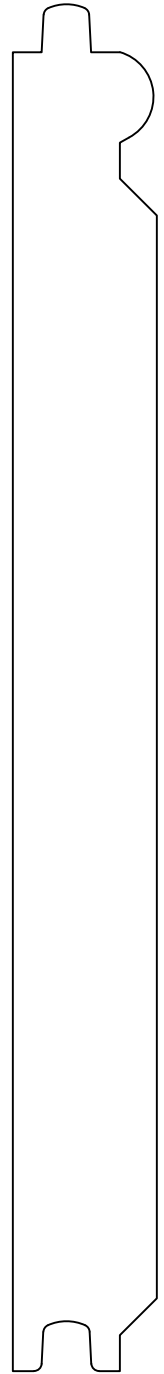

GCM3533  
3/4 X 7 1/8

# GRAYCO BUILDING CENTER

WWW.GRAYCOINC.COM

BLUFFTON  
345 BUCK ISLAND RD, BLUFFTON SC 29910  
(843) 815-5788 FAX 815-5799

LADY'S ISLAND  
20 SAMS POINT WAY, BEAUFORT SC 29907  
(843) 522-9994 FAX 522-9972

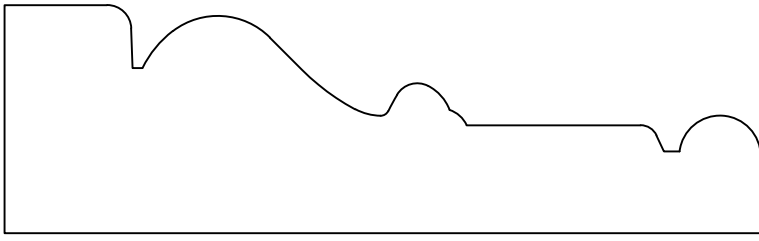

GCM1189  
1<sup>3</sup>/<sub>16</sub> X 3<sup>15</sup>/<sub>16</sub>

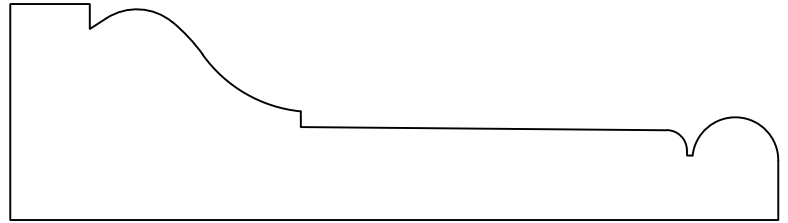

GCM4  
1<sup>1</sup>/<sub>8</sub> X 4"

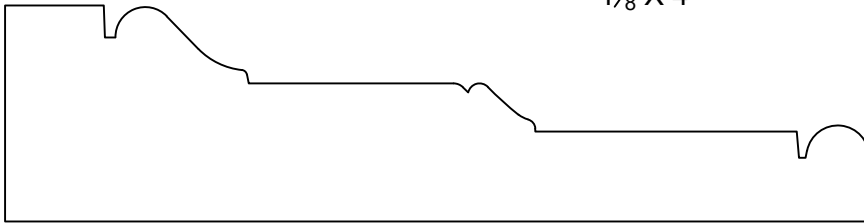

GCM1187  
1<sup>1</sup>/<sub>8</sub> X 4<sup>1</sup>/<sub>2</sub>

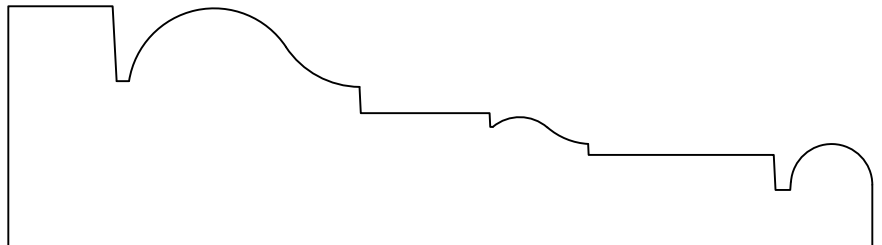

GCM1188  
1<sup>1</sup>/<sub>4</sub> X 4<sup>1</sup>/<sub>2</sub>

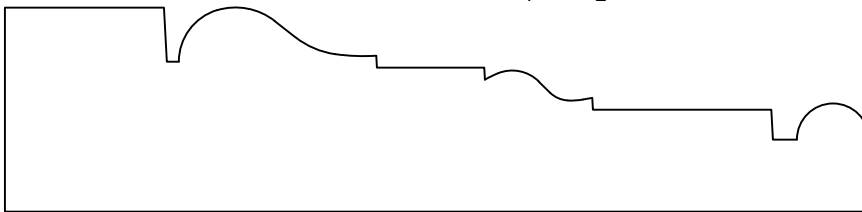

GCM9904  
1<sup>1</sup>/<sub>16</sub> X 4<sup>1</sup>/<sub>2</sub>

# GRAYCO BUILDING CENTER

WWW.GRAYCOINC.COM

BLUFFTON  
345 BUCK ISLAND RD, BLUFFTON SC 29910  
(843) 815-5788 FAX 815-5799

LADY'S ISLAND  
20 SAMS POINT WAY, BEAUFORT SC 29907  
(843) 522-9994 FAX 522-9972

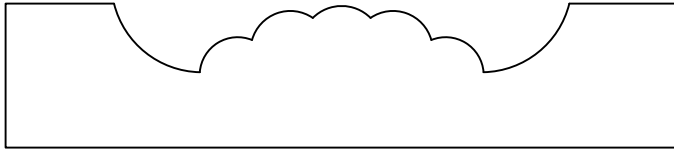

GCM26  
3/4 X 3 1/2

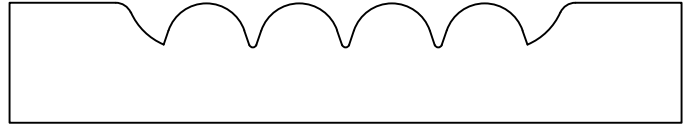

GCM1191  
5/8 X 3 1/2

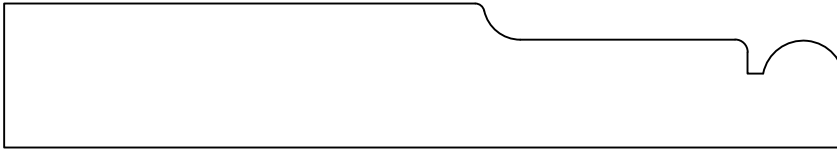

GCM1190  
3/4 X 4 3/8

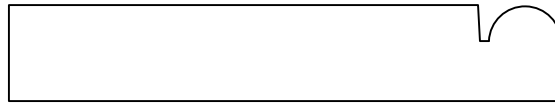

GCM8801  
1/2 X 2 7/8

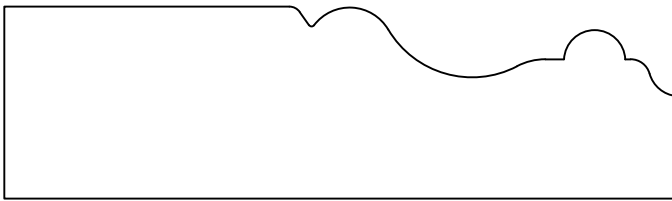

GCM1197  
1 X 3 1/2

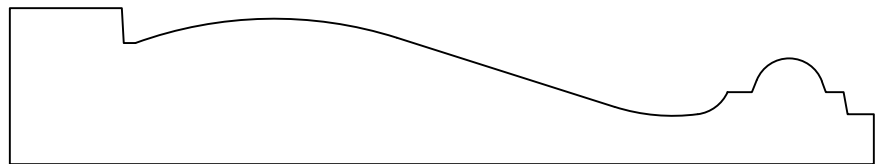

GCM1183  
1 3/16 X 4 1/2

# GRAYCO BUILDING CENTER

WWW.GRAYCOINC.COM

BLUFFTON  
345 BUCK ISLAND RD, BLUFFTON SC 29910  
(843) 815-5788 FAX 815-5799

LADY'S ISLAND  
20 SAMS POINT WAY, BEAUFORT SC 29907  
(843) 522-9994 FAX 522-9972

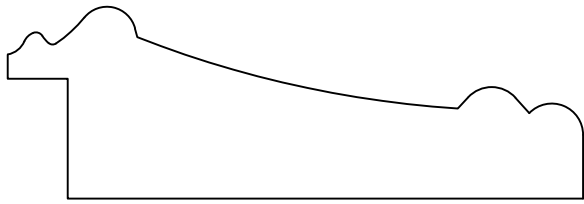

GCM9028  
1 X 3

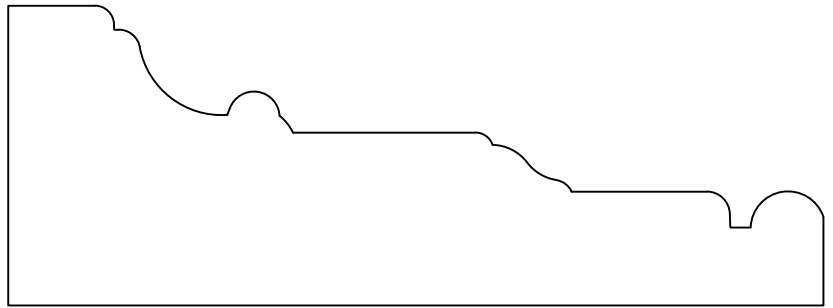

GCM1192  
1<sup>5</sup>/<sub>16</sub> X 4<sup>1</sup>/<sub>4</sub>

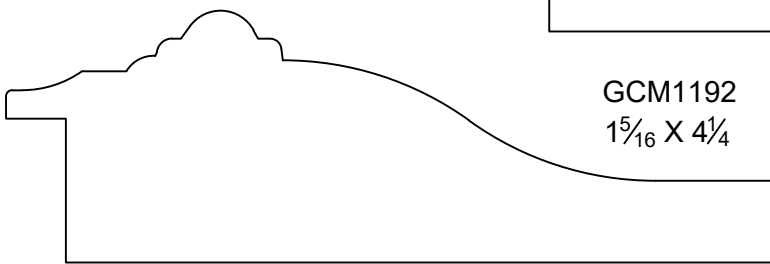

GCM9029  
1<sup>5</sup>/<sub>16</sub> X 4

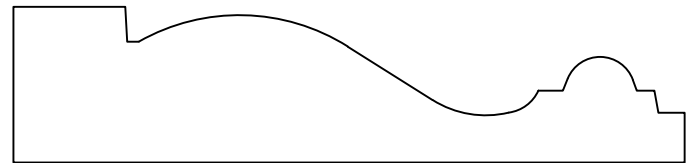

GCM1184  
1<sup>3</sup>/<sub>16</sub> X 3<sup>1</sup>/<sub>2</sub>

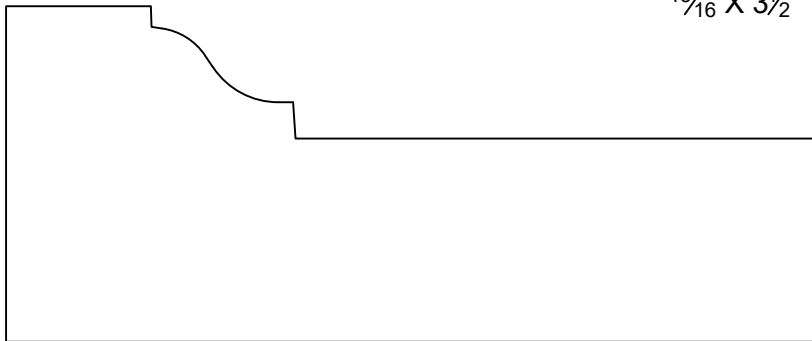

GCM1196  
1<sup>3</sup>/<sub>4</sub> X 4<sup>1</sup>/<sub>4</sub>

# GRAYCO BUILDING CENTER

WWW.GRAYCOINC.COM

BLUFFTON  
345 BUCK ISLAND RD, BLUFFTON SC 29910  
(843) 815-5788 FAX 815-5799

LADY'S ISLAND  
20 SAMS POINT WAY, BEAUFORT SC 29907  
(843) 522-9994 FAX 522-9972

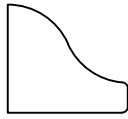

GCM9559 STOP  
9/16 X 5/8

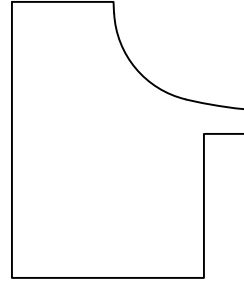

GCM2521  
1 7/16 X 1 1/4

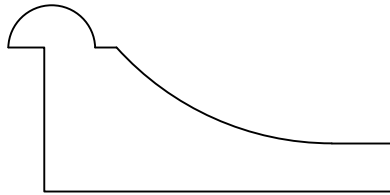

GCM9829  
3 1/32 X 2"

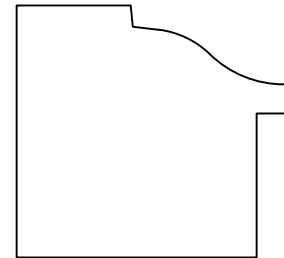

GCM2522  
1 5/16 X 1 7/16

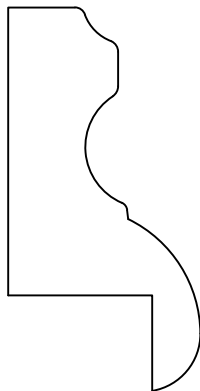

GCM2036  
1 X 2"

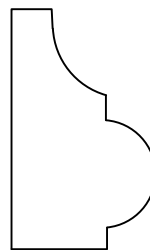

GCM2040  
3/4 X 1 1/4

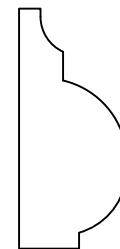

GCM1201  
9/16 X 1 1/4

# GRAYCO BUILDING CENTER

WWW.GRAYCOINC.COM

BLUFFTON  
345 BUCK ISLAND RD, BLUFFTON SC 29910  
(843) 815-5788 FAX 815-5799

LADY'S ISLAND  
20 SAMS POINT WAY, BEAUFORT SC 29907  
(843) 522-9994 FAX 522-9972

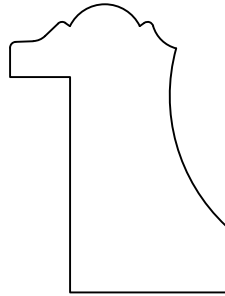

GCM9030  
1 1/8 X 1 1/2

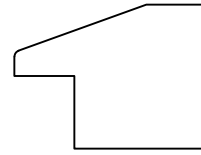

GCM9027  
3/4 X 1

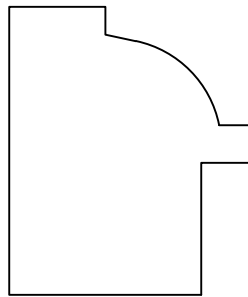

GCM2520  
1 1/4 X 1 1/2

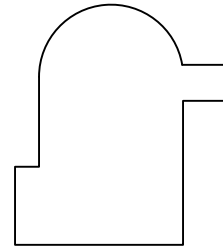

GCM513  
1 1/4 X 1 1/8

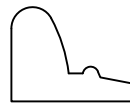

GCM6072  
5/8 X 1 5/32

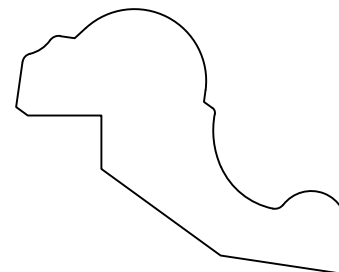

GCM5524  
7/8 X 2"

# GRAYCO BUILDING CENTER

WWW.GRAYCOINC.COM

BLUFFTON  
345 BUCK ISLAND RD, BLUFFTON SC 29910  
(843) 815-5788 FAX 815-5799

LADY'S ISLAND  
20 SAMS POINT WAY, BEAUFORT SC 29907  
(843) 522-9994 FAX 522-9972

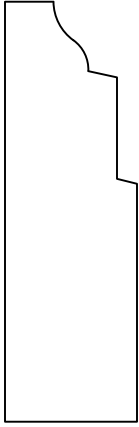

GCM8023  
1 1/16 X 2 3/16

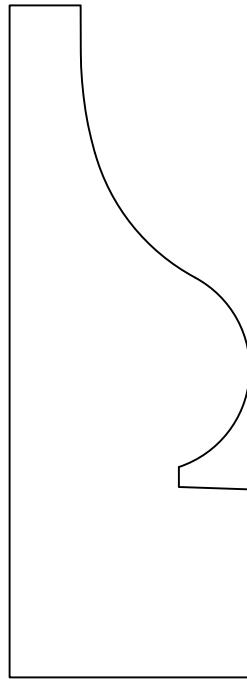

GCM8253  
1 1/4 X 3 1/2

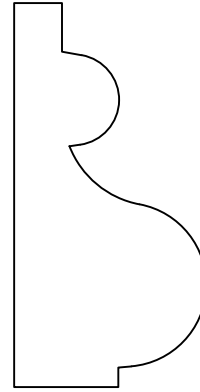

GCM2039  
1 X 2

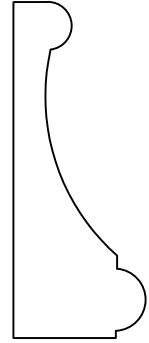

GCM2038  
1 1/16 X 1 3/4

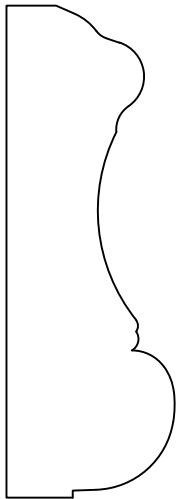

GCM6070  
7/8 X 2 9/16

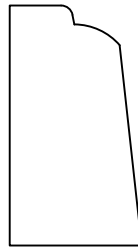

GCM8504  
1 1/16 X 1 1/4



GCM2037  
3/4 X 2 3/8

# GRAYCO BUILDING CENTER

WWW.GRAYCOINC.COM

BLUFFTON  
345 BUCK ISLAND RD, BLUFFTON SC 29910  
(843) 815-5788 FAX 815-5799

LADY'S ISLAND  
20 SAMS POINT WAY, BEAUFORT SC 29907  
(843) 522-9994 FAX 522-9972



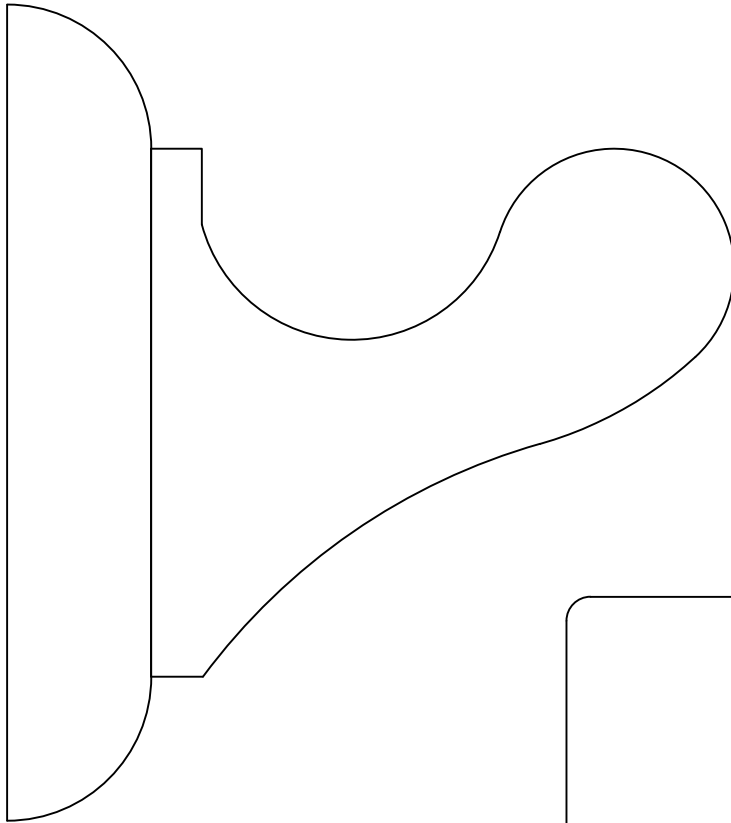

GCM5059  
 $\frac{3}{4} \times 4\frac{1}{4}$   
 $2\frac{3}{4} \times 3\frac{1}{16}$

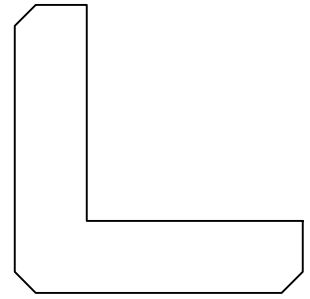

GCM8022  
 $1\frac{1}{2} \times 1\frac{1}{2}$

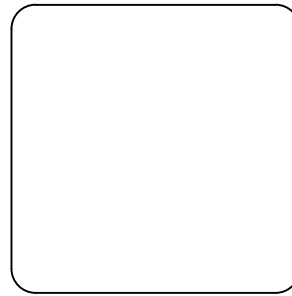

GCM8026  
 $1\frac{1}{2} \times 1\frac{1}{2}$

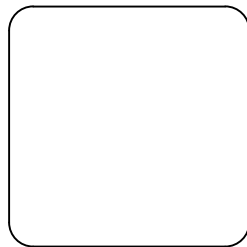

GCM8025  
 $1\frac{1}{4} \times 1\frac{1}{4}$

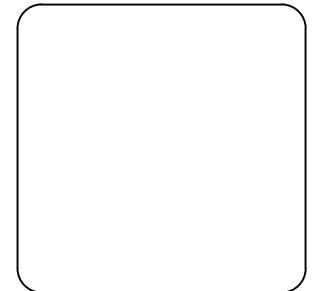

GCM PICKET  
 $1\frac{1}{2} \times 1\frac{1}{2}$

# GRAYCO BUILDING CENTER

[WWW.GRAYCOINC.COM](http://WWW.GRAYCOINC.COM)

BLUFFTON  
345 BUCK ISLAND RD, BLUFFTON SC 29910  
(843) 815-5788 FAX 815-5799

LADY'S ISLAND  
20 SAMS POINT WAY, BEAUFORT SC 29907  
(843) 522-9994 FAX 522-9972

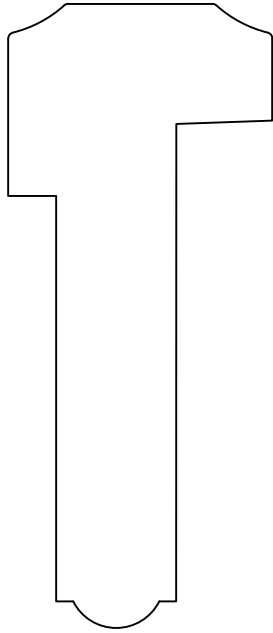

GCM9536  
1<sup>3</sup>/<sub>8</sub> X VARIES

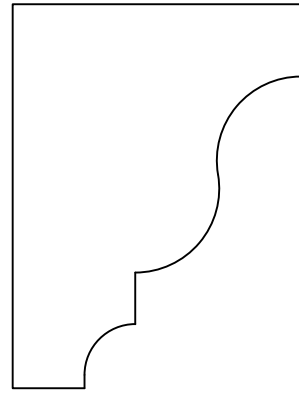

GCM6071  
1<sup>1</sup>/<sub>2</sub> X 2

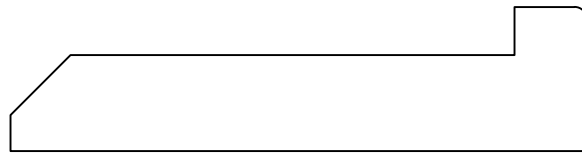

SADDLE  
3<sup>3</sup>/<sub>4</sub> X VARIES

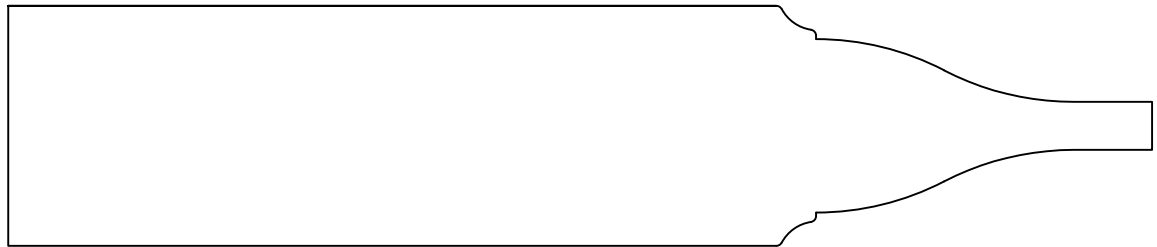

GCM9560  
1<sup>1</sup>/<sub>4</sub> PANEL

# GRAYCO BUILDING CENTER

WWW.GRAYCOINC.COM

BLUFFTON  
345 BUCK ISLAND RD, BLUFFTON SC 29910  
(843) 815-5788 FAX 815-5799

LADY'S ISLAND  
20 SAMS POINT WAY, BEAUFORT SC 29907  
(843) 522-9994 FAX 522-9972